



# Spire STL Pipeline Project

Resource Report 7  
Soils

FERC Docket No. CP17-40-\_\_ \_\_

Amendment to FERC Application  
April 2017

Public



<b>RESOURCE REPORT 7 - SOILS</b>	
<b>SUMMARY OF FILING INFORMATION</b>	
<b>Information</b>	<b>Found in</b>
1. Identify, describe, and group by milepost the soils affected by the proposed pipeline and aboveground facilities - Title 18 Code of Federal Regulations (CFR) part (§) 380.12(I)(1)	Table 7.1-1 and Appendix 7-B.
2. For aboveground facilities that would occupy sites over 5 acres, determine the acreage of prime farmland soils that would be affected by construction and operation - 18 CFR § 380.12(I)(2)	Table 7.3-1.
3. Describe by milepost potential impacts on soils - 18 CFR § 380.12(I)(3,4)	Table 7.1-1 and Appendix 7-B.
4. Identify proposed mitigation to minimize impact on soils and compare with the staff's Upland Erosion Control, Revegetation, and Maintenance Plan - 18 CFR § 380.12(I)(5)	Section 7.5.
<b>INFORMATION RECOMMENDED OR OFTEN MISSING</b>	
1. If the applicant generally proposes to adopt the FERC staff's Plan except at certain locations, identify on a site-specific basis locations where alternative measures are proposed, and describe the alternative measures that will ensure an equal or greater level of protection.	Section 7.5 and Resource Report 1, Appendix 1-F.
2. Identify invasive species and/or noxious weeds that occur in the area and measure to prevent the introduction and/or spread of these species.	Resource Report 3, Appendix 2-B
3. Provide documentation of the consultation with the NRCS or other applicable agencies regarding seed mixes, erosion control, and invasive species/noxious weeds.	Section 7.4.



## Table of Contents

Soils.....	7-1
7.1 Pipeline.....	7-1
7.2 Aboveground Facilities.....	7-8
7.2.1 Access Roads.....	7-8
7.2.2 Staging Areas.....	7-9
7.3 Construction/Operation Impacts.....	7-9
7.3.1 Erosion Hazard.....	7-12
7.3.2 Compaction Prone.....	7-12
7.3.3 Revegetation Concerns.....	7-13
7.3.4 Potential for Introduction of Stones and Rocks into Topsoil.....	7-13
7.3.5 Prime or Unique Farmland or Farmland of Statewide Importance.....	7-14
7.3.6 Hydric Soils.....	7-15
7.4 Consultations.....	7-16
7.4.1 Illinois.....	7-16
7.4.2 Missouri.....	7-16
7.5 Mitigation.....	7-18
7.5.1 Soil Erosion.....	7-18
7.5.2 Soil Compaction.....	7-19
7.5.3 Introduction of Rock into Topsoil.....	7-19
7.5.4 Post-Construction Revegetation.....	7-19
7.5.5 Contaminated Soils.....	7-23
7.6 References.....	7-23

### Tables

7.1-1	Selected Physical and Interpretive Characteristics of the Soil Map Units within the Project Area.....	7-2
7.3-1	Acres of Soil Characteristics Affected by the Proposed Pipeline.....	7-10
7.4-1	Seed Mixes Associated with Conservation Program Tracts.....	7-17
7.5-1	Recommended Forested Upland Seed Mix.....	7-20
7.5-2	Recommended Forested Lowland Seed Mix.....	7-21
7.5-3	Recommended Non-Agriculture Meadow Seed Mix.....	7-21



7.5-4	Recommended Supplemental Pollinator Seed Mix.....	7-22
7.5-5	Recommend Cover Crop Seed Mixes .....	7-22

Appendices

7-A	Soils Mapping
7-B	Soil Characteristics by Milepost and Soil Descriptions
7-C	Agricultural Impact Mitigation Agreement



## Acronyms and Abbreviations

AIMA	Agricultural Impact Mitigation Agreement
ATWS	additional temporary workspace
BMP	Best Management Practice
CFR	Code of Federal Regulations
E&SCs	erosion and sediment controls
E&SCP	Erosion and Sediment Control Plan
FERC	Federal Energy Regulatory Commission
IDOA	Illinois Department of Agriculture
MLV	mainline valve
MP	Milepost
M&R	metering and regulating
Plan	FERC's Upland Erosion Control, Revegetation, and Maintenance Plan
Procedures	FERC's Wetland and Waterbody Construction and Mitigation Procedures
PLS	Pure Live Seed
Project	Spire STL Pipeline Project
REX	Rockies Express Pipeline LLC
Spire	Spire STL Pipeline LLC
SWCD	Soil and Water Conservation District
USACE	United States Army Corps of Engineers
USDA	United States Department of Agriculture
NRCS	Natural Resources Conservation Service
WSS	Web Soil Survey



## Soils

This resource report identifies and describes the soils within Spire STL Pipeline LLC's ("Spire's") Spire STL Pipeline Project ("Project"). This includes associated soil characteristics and limitations as well as the proposed mitigation for impacts to these soils.

### 7.1 Pipeline

Soil information for the Project area was obtained from the United States Department of Agriculture, Natural Resources Conservation Service ("USDA-NRCS") Soil Surveys of Scott, Greene and Jersey Counties, Illinois and St. Charles and St. Louis Counties, Missouri (USDA-NRCS 2015a and USDA-NRCS 2015b). The USDA-NRCS Web Soil Survey ("WSS") is a comprehensive digital version of the original soil surveys developed by the NRCS for use with geographic information systems. This resource provides the most detailed level of soil information for natural resource planning and management. The WSS is a mapping tool linked to an attribute database that gives the location of the component soils and their properties for each soil map unit (USDA-NRCS 2015a). The attribute data consists of interpretive groupings, physical properties, and chemical properties. Attribute data apply to the whole soil (e.g., listed hydric, prime farmland soils, or slope calls) as well as to the layer data for soil horizons (e.g., texture or permeability). The soil attribute data can be used in conjunction with spatial data to describe the soils in a particular area. Soils mapping for the Project is provided in Appendix 7-A. A table of the soils by milepost ("MP") and a description of each soil affected by the Project is provided in Appendix 7-B. Selected physical and interpretive characteristics of the soil map units crossed by the Project area are presented in Table 7.1-1.



**Table 7.1-1. Selected Physical and Interpretive Characteristics of the Soil Map Units within the Project Area**

County Name	County Code	County/Map Unit Symbol	Map Unit Name	Component Name	Component Percent	Percent Slope		Surface Texture <sup>1</sup>	Drainage Class <sup>2</sup>	Permeability <sup>3</sup>	Taxonomic Classification	Parent Material	Landforms
						Low	High						
Scott	IL171	8E2	Hickory silt loam, 18 to 25 percent slopes, eroded	Hickory	90	18	25	SIL	W	M - MR	Fine-loamy, mixed, active, mesic Typic Hapludalfs	Illinois till	Ground moraines, till plains
Scott	IL171	8F	Hickory silt loam, 18 to 35 percent slopes	Hickory	89	18	35	SIL	W	M - MR	Fine-loamy, mixed, active, mesic Typic Hapludalfs	Loamy till	Till Plains, ground moraines
Scott	IL171	17A	Keomah silt loam, zero to two percent slopes	Keomah	90	0	2	SIL	SP	S - MS	Fine, smectitic, mesic Aeric Endoaqualfs	Loess	Ground moraines, till plains
Scott	IL171	19C3	Sylvan silty clay loam, 5 to 10 percent slopes, severely eroded	Sylvan	100	5	10	SICL	W	M - MR	Fine-silty, mixed, superactive, mesic Typic Hapludalfs	Loess	Ground moraines
Scott	IL171	43A	Ipava silt loam, zero to two percent slopes	Ipava	85	0	2	SIL	SP	MS - M	Fine, smectitic, mesic Aquic Argiudolls	Loess	Till plains, broad ground moraines
Scott	IL171	50A	Virden silty clay loam, zero to two percent slopes	Virden	90	0	2	SICL	P	MS - M	Fine, smectitic, mesic Vertic Argiaquolls	Loess	Till Plains, ground moraines
Scott	IL171	119D2	Elco silt loam, 10 to 18 percent slopes, eroded	Elco	94	10	18	SIL	MW	S - M	Fine-silty, mixed, superactive, mesic Oxyaquic Hapludalfs	Loess over paleosol formed in till	Ground moraines
Scott	IL171	119D3	Elco silty clay loam, 10 to 18 percent slopes, severely eroded	Elco	94	10	18	SICL	MW	S - M	Fine-silty, mixed, superactive, mesic Oxyaquic Hapludalfs	Loess over paleosol formed in till	Ground moraines
Scott	IL171	257A	Clarksdale silt loam, zero to two percent slopes	Clarksdale	90	0	2	SIL	SP	MS - M	Fine, smectitic, mesic Udollic Endoaqualfs	Loess	Ground moraines, till plains
Scott	IL171	279B	Rozetta silt loam, two to five percent slopes	Rozetta	90	2	5	SIL	W	M - MR	Fine-silty, mixed, superactive, mesic Typic Hapludalfs	Loess	Ground moraines, till plains
Scott	IL171	279C2	Rozetta silt loam, five to 10 percent slopes, eroded	Rozetta	94	5	10	SIL	W	M - MR	Fine-silty, mixed, superactive, mesic Typic Hapludalfs	Loess	Ground moraines, till plains
Scott	IL171	279C3	Rozetta silty clay loam, five to 10 percent slopes, severely eroded	Rozetta	94	5	10	SICL	W	M - MR	Fine-silty, mixed, superactive, mesic Typic Hapludalfs	Loess	Till Plains, ground moraines
Scott	IL171	280C2	Fayette silt loam, five to 10 percent slopes, eroded	Fayette	95	5	10	SIL	W	M - MR	Fine-silty, mixed, superactive, mesic Typic Hapludalfs	Loess	Side slopes and ground moraines
Scott	IL171	280D2	Fayette silt loam, 10 to 18 percent slopes, eroded	Fayette	95	10	18	SIL	W	M - MR	Fine-silty, mixed, superactive, mesic Typic Hapludalfs	Loess	Ground moraines
Scott	IL171	280D3	Fayette silty clay loam, 10 to 18 percent slopes, severely eroded	Fayette	95	10	18	SICL	W	M - MR	Fine-silty, mixed, superactive, mesic Typic Hapludalfs	Loess	Ground moraines
Scott	IL171	915D2	Elco-Ursa silt loams, 10 to 18 percent slopes, eroded	Elco	55	10	18	SIL	MW	S - M	Fine-silty, mixed, superactive, mesic Oxyaquic Hapludalfs	Loess	Hillslopes
				Ursa	35	10	18	SIL	W	S - MS	Fine, smectitic, mesic Chromic Vertic Hapludalfs	Loess	Hillslopes
Scott	IL171	3078A	Arenzville silt loam, zero to two percent slopes, frequently flooded	Arenzville	95	0	2	SIL	W	M - MR	Coarse-silty, mixed, superactive, nonacid, mesic Typic Udifluvents	Silty alluvium	Flood plains
Scott	IL171	3333A	Wakeland silt loam, zero to two percent slopes, frequently flooded	Wakeland	90	0	2	SIL	SP	M - MR	Coarse-silty, mixed, superactive, nonacid, mesic Aeric Fluvaquents	Alluvium	Flood plains
Greene	IL061	8D	Hickory silt loam, 10 to 18 percent slopes	Hickory	90	10	18	SIL	W	M - MR	Fine-loamy, mixed, active, mesic Typic Hapludalfs	Loamy till	Ground moraines, till plains
Greene	IL061	8D2	Hickory silt loam, 10 to 18 percent slopes, eroded	Hickory	90	10	18	SIL	W	M - MR	Fine-loamy, mixed, active, mesic Typic Hapludalfs	Illinois till	Ground moraines, till plains
Greene	IL061	8F	Hickory silt loam, 18 to 35 percent slopes	Hickory	89	18	35	SIL	W	M - MR	Fine-loamy, mixed, active, mesic Typic Hapludalfs	Loamy till	Ground moraines, till plains



**Table 7.1-1. Selected Physical and Interpretive Characteristics of the Soil Map Units within the Project Area (Continued)**

County Name	County Code	County/Map Unit Symbol	Map Unit Name	Component Name	Component Percent	Percent Slope		Surface Texture <sup>1</sup>	Drainage Class <sup>2</sup>	Permeability <sup>3</sup>	Taxonomic Classification	Parent Material	Landforms
						Low	High						
Greene	IL061	8F2	Hickory silt loam, 18 to 35 percent slopes, eroded	Hickory	90	18	35	SIL	W	M - MR	Fine-loamy, mixed, active, mesic Typic Hapludalfs	Illinois till	Ground moraines, till plains
Greene	IL061	17A	Keomah silt loam, zero to two percent slopes	Keomah	90	0	2	SIL	SP	S - MS	Fine, smectitic, mesic Aeric Endoaqualfs	Loess	Ground moraines, till plains
Greene	IL061	45A	Denny silt loam, zero to two percent slope	Denny	95	0	2	SIL	P	S - MS	Fine, smectitic, mesic Mollic Albaqualfs	Loess	Depressions, till plains
Greene	IL061	47A	Viriden silt loam, zero to two percent slopes	Viriden	90	0	2	SIL	P	MS - M	Fine, smectitic, mesic Vertic Argiaquolls	Loess	Till Plains, ground moraines
Greene	IL061	51A	Muscatune silt loam, zero to two percent slopes	Muscatune	90	0	2	SIL	SP	M - MR	Fine-silty, mixed, superactive, mesic Aquic Arguidolls	Peoria loess	Ground moraines, till plains
Greene	IL061	51B	Muscatune silt loam, two to five percent slopes	Muscatune	95	2	5	SIL	SP	M - MR	Fine-silty, mixed, superactive, mesic Aquic Arguidolls	Peoria loess	Till Plains, ground moraines
Greene	IL061	61A	Atterberry silt loam, zero to two percent slopes	Atterberry	98	0	2	SIL	SP	M - MR	Fine-silty, mixed, superactive, mesic Udollic Endoaqualfs	Loess	Flats on ground moraines
Greene	IL061	68A	Sable silty clay loam, zero to two percent slopes	Sable	85	0	2	SICL	P	M - MR	Fine-silty, mixed, superactive, mesic Typic Endoaquolls	Loess	Till Plains, swales
Greene	IL061	86B	Oscos silt loam, two to five percent slopes	Oscos	90	2	5	SIL	W	M - MR	Fine-silty, mixed, superactive, mesic Typic Arguidolls	Loess	Ground moraines, till plains
Greene	IL061	86C2	Oscos silt loam, five to ten percent slopes	Oscos	90	5	10	SIL	W	M - MR	Fine-silty, mixed, superactive, mesic Typic Arguidolls	Loess	Ground moraines, till plains
Greene	IL061	134C2	Camden silt loam, 5 to 10 percent slopes, eroded	Camden	97	5	10	SIL	W	M-MR	Fine-silty, mixed, superactive, mesic Typic Hapludalfs	Loess over stratified loamy outwash	Stream terraces
Greene	IL061	242A	Kendall silt loam, zero to two percent slopes	Kendall	90	0	2	SIL	SP	M - MR	Fine-silty, mixed, superactive, mesic Aeric Endoaqualfs	Loess over outwash	Outwash plains
Greene	IL061	257B	Clarksdale silt loam, two to five percent slopes	Clarksdale	90	2	5	SIL	SP	MS - M	Fine, smectitic, mesic Udollic Endoaqualfs	Loess	Ground moraines, till plains
Greene	IL061	279B	Rozetta silt loam, two to five percent slopes	Rozetta	90	2	5	SIL	W	M - MR	Fine-silty, mixed, superactive, mesic Typic Hapludalfs	Loess	Ground moraines, till plains
Greene	IL061	279C2	Rozetta silt loam, five to 10 percent slopes, eroded	Rozetta	94	5	10	SIL	W	M - MR	Fine-silty, mixed, superactive, mesic Typic Hapludalfs	Loess	Ground moraines, till plains
Greene	IL061	279D2	Rozetta silt loam, 10 to 18 percent slopes, eroded	Rozetta	94	10	18	SIL	W	M - MR	Fine-silty, mixed, superactive, mesic Typic Hapludalfs	Loess	Ground moraines, till plains
Greene	IL061	280B	Fayette silt loam, two to five percent slopes	Fayette	90	2	5	SIL	W	M - MR	Fine-silty, mixed, superactive, mesic Typic Hapludalfs	Loess	Ground moraines
Greene	IL061	280C2	Fayette silt loam, five to 10 percent slopes, eroded	Fayette	95	5	10	SIL	W	M - MR	Fine-silty, mixed, superactive, mesic Typic Hapludalfs	Loess	Side slopes and ground moraines
Greene	IL061	280D	Fayette silt loam, 10 to 18 percent slopes	Fayette	92	10	18	SIL	W	M - MR	Fine-silty, mixed, superactive, mesic Typic Hapludalfs	Loess	Ground moraines, uplands
Greene	IL061	280D2	Fayette silt loam, 10 to 18 percent slopes, eroded	Fayette	95	10	18	SIL	W	M - MR	Fine-silty, mixed, superactive, mesic Typic Hapludalfs	Loess	Ground moraines
Greene	IL061	675B	Greenbush silt loam, two to five percent slopes	Greenbush	90	2	5	SIL	W	M - MR	Fine-silty, mixed, superactive, mesic Mollic Hapludalfs	Loess	Ground moraines
Greene	IL061	675C2	Greenbush silt loam, five to 10 percent slopes, eroded	Greenbush	95	5	10	SIL	W	M - MR	Fine-silty, mixed, superactive, mesic Mollic Hapludalfs	Loess	Ridges, side slopes on ground moraines
Greene	IL061	3070A	Beaucoup silty clay loam, zero to two percent slopes, frequently flooded	Beaucoup	90	0	2	SICL	P	MS - M	Fine-silty, mixed, superactive, mesic Fluvaquentic Endoaquolls	Alluvium	Flood plains





**Table 7.1-1. Selected Physical and Interpretive Characteristics of the Soil Map Units within the Project Area (Continued)**

County Name	County Code	County/Map Unit Symbol	Map Unit Name	Component Name	Component Percent	Percent Slope		Surface Texture <sup>1</sup>	Drainage Class <sup>2</sup>	Permeability <sup>3</sup>	Taxonomic Classification	Parent Material	Landforms
						Low	High						
Greene	IL061	3074A	Radford silt loam, zero to two percent slopes, frequently flooded	Radford	90	0	2	SIL	SP	M - MR	Fine-silty, mixed, superactive, mesic Fluvaquentic Hapludolls	Alluvium	Flood plains
Greene	IL061	3331A	Haymond silt loam, zero to two percent slopes, frequently flooded	Haymond	90	0	2	SIL	W	M - MR	Coarse-silty, mixed, superactive, mesic Dystric Fluventic Eutrudepts	Silty Alluvium	Flood plains
Greene	IL061	3451A	Lawson silt loam, zero to two percent slopes, frequently flooded	Lawson	90	0	2	SIL	SP	M - MR	Fine-silty, mixed, superactive, mesic Aquic Cumulic Hapludolls	Alluvium	Flood plains
Greene	IL061	7148A	Proctor silt loam, zero to two percent slopes, rarely flooded	Proctor	95	0	2	SIL	W	M - MR	Fine-loamy, mixed, mesic Aquic Argiudolls	Loess over outwash	Flood plains
Greene	IL061	W	Water	N/A	N/A	N/A	N/A	N/A	N/A	N/A	Fine-silty, mixed, superactive, mesic Typic Argiudolls	N/A	N/A
Jersey	IL083	8D2	Hickory silt loam, 10 to 18 percent slopes, eroded	Hickory	90	10	18	SIL	W	M - MR	Fine-loamy, mixed, active, mesic Typic Hapludalfs	Illinois till	Ground moraines, till plains
Jersey	IL083	8D3	Hickory clay loam, 10 to 18 percent slopes, severely eroded	Hickory	90	10	18	CL	W	M-MR	Fine-loamy, mixed, active, mesic Typic Hapludalfs	Illinois till	Ground moraines
Jersey	IL083	8F2	Hickory silt loam, 18 to 35 percent slopes, eroded	Hickory	90	18	35	SIL	W	M - MR	Fine-loamy, mixed, active, mesic Typic Hapludalfs	Illinois till	Ground moraines, till plains
Jersey	IL083	8G	Hickory silt loam, 35 to 60 percent slopes	Hickory	90	35	60	SIL	W	M - MR	Fine-loamy, mixed, active, mesic Typic Hapludalfs	Loamy till	Ground moraines, till plains
Jersey	IL083	16A	Rushville silt loam, zero to two percent slopes	Rushville	90	0	2	SIL	P	VS - S	Fine, smectitic, mesic Typic Albaqualfs	Loess	Depressions on ground moraines
Jersey	IL083	51A	Muscataune silt loam, zero to two percent slopes	Muscataune	90	0	2	SIL	SP	M - MR	Fine-silty, mixed, superactive, mesic Aquic Argiudolls	Peoria loess	Ground moraines, till plains
Jersey	IL083	61A	Atterberry silt loam, zero to two percent slopes	Atterberry	98	0	2	SIL	SP	M - MR	Fine-silty, mixed, superactive, mesic Udollic Endoaqualfs	Loess	Flats on ground moraines
Jersey	IL083	68A	Sable silty clay loam, zero to two percent slopes	Sable	85	0	2	SICL	P	M - MR	Fine-silty, mixed, superactive, mesic Typic Endoaquolls	Loess	Till Plains, swales
Jersey	IL083	79B	Menfro silt loam, two to five percent slopes	Menfro	90	2	5	SIL	W	M - MR	Fine-silty, mixed, superactive, mesic Typic Hapludalfs	Loess	Ground moraines, Loess hills
Jersey	IL083	79C2	Menfro silt loam, five to 10 percent slopes, eroded	Menfro	85	5	10	SIL	W	M - MR	Fine-silty, mixed, superactive, mesic Typic Hapludalfs	Loess	Ground moraines, Loess hills
Jersey	IL083	79D2	Menfro silt loam, 10 to 18 percent slopes, eroded	Menfro	90	10	18	SIL	W	M - MR	Fine-silty, mixed, superactive, mesic Typic Hapludalfs	Loess	Loess hills on ground moraines
Jersey	IL083	86B	Osco silt loam, two to five percent slopes	Osco	90	2	5	SIL	W	M - MR	Fine-silty, mixed, superactive, mesic Typic Argiudolls	Loess	Ground moraines, till plains
Jersey	IL083	119C2	Elco silt loam, five to 10 percent slopes, eroded	Elco	97	5	10	SIL	MW	S - M	Fine-silty, mixed, superactive, mesic Oxyaquic Hapludalfs	Loess over paleosol formed in till	Hillslopes on ground moraines
Jersey	IL083	119C3	Elco silty clay loam, five to 10 percent slopes, severely eroded	Elco	95	5	10	SICL	MW	S - M	Fine-silty, mixed, superactive, mesic Oxyaquic Hapludalfs	Loess over paleosol formed in till	Ground moraines
Jersey	IL083	119D2	Elco silt loam, 10 to 18 percent slopes, eroded	Elco	94	10	18	SIL	MW	S - M	Fine-silty, mixed, superactive, mesic Oxyaquic Hapludalfs	Loess over paleosol formed in till	Hillslopes on ground moraines
Jersey	IL083	119D3	Elco silty clay loam, 10 to 18 percent slopes, severely eroded	Elco	95	10	18	SICL	MW	S - M	Fine-silty, mixed, superactive, mesic Oxyaquic Hapludalfs	Loess over paleosol formed in till	Ground moraines
Jersey	IL083	259C2	Assumption silt loam, five to 10 percent slopes, eroded	Assumption	90	5	10	SIL	MW	S - M	Fine-silty, mixed, superactive, mesic Mollic Oxyaquic Hapludalfs	Fine-silty loess over paleosol formed in loamy till	Till Plains, ground moraines



**Table 7.1-1. Selected Physical and Interpretive Characteristics of the Soil Map Units within the Project Area (Continued)**

County Name	County Code	County/Map Unit Symbol	Map Unit Name	Component Name	Component Percent	Percent Slope		Surface Texture <sup>1</sup>	Drainage Class <sup>2</sup>	Permeability <sup>3</sup>	Taxonomic Classification	Parent Material	Landforms
						Low	High						
Jersey	IL083	267A	Caseyville silt loam, zero to two percent slopes	Caseyville	90	0	2	SIL	SP	M - MR	Fine-silty, mixed, superactive, mesic Aeric Endoaqualfs	Loess	Ground moraines
Jersey	IL083	278A	Stronghurst silt loam, zero to two percent slopes	Stronghurst	90	0	2	SIL	SP	M - MR	Fine-silty, mixed, superactive, mesic Aeric Endoaqualfs	Loess	Flats on ground moraines
Jersey	IL083	279B	Rozetta silt loam, two to five percent slopes	Rozetta	90	2	5	SIL	W	M - MR	Fine-silty, mixed, superactive, mesic Typic Hapludalfs	Loess	Ground moraines, till plains
Jersey	IL083	279C2	Rozetta silt loam, five to 10 percent slopes, eroded	Rozetta	94	5	10	SIL	W	M - MR	Fine-silty, mixed, superactive, mesic Typic Hapludalfs	Loess	Ground moraines, till plains
Jersey	IL083	279C3	Rozetta silty clay loam, five to 10 percent slopes, severely eroded	Rozetta	94	5	10	SICL	W	M - MR	Fine-silty, mixed, superactive, mesic Typic Hapludalfs	Loess	Till Plains, ground moraines
Jersey	IL083	279D2	Rozetta silt loam, 10 to 18 percent slopes, eroded	Rozetta	94	10	18	SIL	W	M - MR	Fine-silty, mixed, superactive, mesic Typic Hapludalfs	Loess	Ground moraines, till plains
Jersey	IL083	279D3	Rozetta silty clay loam, 10 to 18 percent slopes, severely eroded	Rozetta	94	10	18	SICL	W	M - MR	Fine-silty, mixed, superactive, mesic Typic Hapludalfs	Loess	Ground moraines
Jersey	IL083	280B	Fayette silt loam, two to five percent slopes	Fayette	90	2	5	SIL	W	M - MR	Fine-silty, mixed, superactive, mesic Typic Hapludalfs	Loess	Ground moraines
Jersey	IL083	280C	Fayette silt loam, five to 10 percent slopes	Fayette	95	5	10	SIL	W	M - MR	Fine-silty, mixed, superactive, mesic Typic Hapludalfs	Loess	Ground moraines
Jersey	IL083	280C2	Fayette silt loam, five to 10 percent slopes, eroded	Fayette	95	5	10	SIL	W	M - MR	Fine-silty, mixed, superactive, mesic Typic Hapludalfs	Loess	Side slopes and ground moraines
Jersey	IL083	280D3	Fayette silty clay loam, 10 to 18 percent slopes, severely eroded	Fayette	95	10	18	SICL	W	M - MR	Fine-silty, mixed, superactive, mesic Typic Hapludalfs	Loess	Hillslopes on ground moraines
Jersey	IL083	477B	Winfield silt loam, two to five percent slopes	Winfield	95	2	5	SIL	MW	M - MR	Fine-silty, mixed, superactive, mesic Oxyaquic Hapludalfs	Loess	Ground moraines, loess hills
Jersey	IL083	477C2	Winfield silt loam, five to 10 percent slopes, eroded	Winfield	95	5	10	SIL	MW	M - MR	Fine-silty, mixed, superactive, mesic Oxyaquic Hapludalfs	Loess	Loess hills on ground moraines
Jersey	IL083	477D3	Winfield silty clay loam, 10 to 18 percent slopes, severely eroded	Winfield	90	10	18	SICL	MW	M - MR	Fine-silty, mixed, superactive, mesic Oxyaquic Hapludalfs	Loess	Loess hills on ground moraines
Jersey	IL083	515B2	Bunkum silt loam, two to five percent slopes, eroded	Bunkum	90	2	5	SIL	SP	MS - M	Fine-silty, mixed, superactive, mesic Aquic Hapludalfs	Loess over silty pedisediment	Ground moraines
Jersey	IL083	515C2	Bunkum silt loam, five to 10 percent slopes, eroded	Bunkum	92	5	10	SIL	SP	MS - M	Fine-silty, mixed, superactive, mesic Aquic Hapludalfs	Loess over silty pedisediment	Ground moraines
Jersey	IL083	515C3	Bunkum silty clay loam, five to 10 percent slopes, severely eroded	Bunkum	93	5	10	SICL	SP	MS - M	Fine-silty, mixed, superactive, mesic Aquic Hapludalfs	Loess over silty pedisediment	Uplands, ground moraines
Jersey	IL083	675B	Greenbush silt loam, two to five percent slopes	Greenbush	90	2	5	SIL	W	M - MR	Fine-silty, mixed, superactive, mesic Mollic Hapludalfs	Loess	Ground moraines
Jersey	IL083	675C2	Greenbush silt loam, five to 10 percent slopes, eroded	Greenbush	95	5	10	SIL	W	M - MR	Fine-silty, mixed, superactive, mesic Mollic Hapludalfs	Loess	Ridges, side slopes on ground moraines
Jersey	IL083	833G	Goss-Menfro complex, 35 to 60 percent slopes	Goss	60	35	60	GR-SIL	W	M - MR	Clayey-skeletal, mixed, active, mesic Typic Paleudalfs	Clayey residuum weathered from cherty limestone	Hillslopes
				Menfro	30	35	60	SIL	W	M - MR	Fine-silty, mixed, superactive, mesic Typic Hapludalfs	Loess	Hillslopes
Jersey	IL083	837G	Rock outcrop, limestone-Lacrescent complex, 35 to 60 percent slopes	Rock Outcrop, Limestone	70	N/A	N/A	N/A	N/A	N/A	N/A	N/A	Bluffs
				Lacrescent	30	35	60	CH-SIL	W	M - MR	Loamy-skeletal, mixed, superactive, mesic Typic Hapludolls	Colluvium	Bluffs



**Table 7.1-1. Selected Physical and Interpretive Characteristics of the Soil Map Units within the Project Area (Continued)**

County Name	County Code	County/Map Unit Symbol	Map Unit Name	Component Name	Component Percent	Percent Slope		Surface Texture <sup>1</sup>	Drainage Class <sup>2</sup>	Permeability <sup>3</sup>	Taxonomic Classification	Parent Material	Landforms
						Low	High						
Jersey	IL083	3333A	Wakeland silt loam, zero to two percent slopes, frequently flooded	Wakeland	90	0	2	SIL	SP	M - MR	Coarse-silty, mixed, superactive, nonacid, mesic Aeric Fluvaquents	Alluvium	Flood plains
Jersey	IL083	3451A	Lawson silt loam, zero to two percent slopes, frequently flooded	Lawson	90	0	2	SIL	SP	M - MR	Fine-silty, mixed, superactive, mesic Aquic Cumulic Hapludolls	Alluvium	Flood plains
Jersey	IL083	3475A	Elsah gravelly loam, zero to two percent slopes, frequently flooded	Elsah	90	0	2	GR-L	W	M - MR	Loamy-skeletal, mixed, superactive, nonacid, mesic Typic Udifluvents	Gravelly alluvium	Flood plains
Jersey	IL083	3634A	Blyton silt loam, zero to two percent slopes, frequently flooded	Blyton	90	0	2	SIL	MW	M - MR	Coarse-silty, mixed, superactive, nonacid, mesic Oxyaquic Udifluvents	Silty alluvium	Flood plains
Jersey	IL083	W	Water	N/A	N/A	N/A	N/A	N/A	N/A	N/A	N/A	N/A	N/A
St. Charles	MO183	13598	Booker silty clay, frequently ponded, zero to two percent slopes, occasionally flooded	Booker	95	0	2	SIC	VP	I - S	Very-fine, smectitic, mesic Cumulic Vertic Endoaquolls	Alluvium	River Valleys and flood plain steps
St. Charles	MO183	36023	Landes fine sandy loam, zero to two percent slopes, occasionally flooded	Landes	90	0	2	FSL	MW	MS - M	Coarse-loamy, mixed, superactive, mesic Fluventic Hapludolls	Alluvium	River Valleys and flood plain steps
St. Charles	MO183	64016	Blase silty clay loam, zero to two percent slopes, rarely flooded	Blase	95	0	2	SICL	SP	S - MS	Clayey over loamy, smectitic, mesic Aquic Hapludolls	Clayey alluvium over loamy alluvium	River Valleys, Stream terraces
St. Charles	MO183	64024	DeSioux loam, zero to two percent slopes, rarely flooded	DeSioux	95	0	2	L	W	MS - M	Coarse-silty, mixed, superactive, mesic Cumulic Hapludolls	Alluvium	River Valleys, Stream terraces
St. Charles	MO183	66012	Blake silt loam, zero to two percent slopes, frequently flooded	Blake	85	0	2	SIL	SP	MS	Fine-silty, mixed, superactive, calcareous, mesic Aquic Udifluvents	Alluvium	River valleys, flood plains
St. Charles	MO183	66019	Lowmo silt loam, zero to two percent slopes, occasionally flooded	Lowmo	85	0	2	SIL	W	MS - M	Coarse-silty, mixed, superactive, mesic Fluventic Hapludolls	Alluvium	River Valleys and flood plain steps
St. Charles	MO183	66059	Peers silty clay loam, zero to two percent slopes, occasionally flooded	Peers	85	0	2	SICL	SP	MS	Fine-silty, mixed, superactive, mesic Fluvaquentic Hapludolls	Alluvium	River Valleys and flood plain steps
St. Charles	MO183	66066	Carlow silty clay loam, zero to two percent slopes, occasionally flooded	Carlow	90	0	2	SICL	P	I - S	Fine, smectitic, mesic Vertic Endoaquolls	Alluvium	River Valleys and flood plain steps
St. Charles	MO183	66100	Portage clay, zero to two percent slopes, occasionally flooded, frequently ponded	Portage	85	0	2	C	VP	I - S	Very-fine, smectitic, mesic Vertic Endoaquolls	Alluvium	River Valleys and flood plain steps
St. Charles	MO183	66110	SansDessein silty clay, zero to two percent slopes, occasionally flooded	SansDessein	90	0	2	SIC	P	S - MS	Fine, smectitic, mesic Fluvaquentic Vertic Endoaquolls	Alluvium	River Valleys and flood plain steps
St. Charles	MO183	66126	Haynie-Treloar-Blake complex, zero to two percent slopes, frequently flooded	Haynie	45	0	2	SIL	W	MS - M	Coarse-silty, mixed, superactive, calcareous, mesic Mollic Udifluvents	Alluvium	River valleys, flood plains
				Treloar	25	0	2	FSL	MW	MS - M	Sandy over loamy, mixed, superactive, calcareous, mesic Oxyaquic Udifluvents	Sandy alluvium over loamy alluvium	River Valleys and flood plain steps
				Blake	20	0	2	SICL	SP	MS	Fine-silty, mixed, superactive, calcareous, mesic Aquic Udifluvents	Alluvium	River valleys, flood plains
St. Charles	MO183	99001	Water	N/A	N/A	N/A	N/A	N/A	N/A	N/A	N/A	N/A	N/A
St. Louis	MO189	13598	Booker silty clay, frequently ponded, zero to two percent slopes, occasionally flooded	Booker	95	0	2	SIC	VP	I - S	Very-fine, smectitic, mesic Cumulic Vertic Endoaquolls	Alluvium	River valleys and floodplain steps
St. Louis	MO189	60001	Menfro silt loam, five to nine percent slopes, eroded	Menfro	100	5	9	SIL	W	MS	Fine-silty, mixed, superactive, mesic Typic Hapludalfs	Loess	Hills, hillslopes
St. Louis	MO189	60003	Menfro silt loam, nine to 14 percent slopes, eroded	Menfro	85	9	14	SIL	W	MS	Fine-silty, mixed, superactive, mesic Typic Hapludalfs	Loess	Hills, hillslopes



**Table 7.1-1. Selected Physical and Interpretive Characteristics of the Soil Map Units within the Project Area (Continued)**

County Name	County Code	County/Map Unit Symbol	Map Unit Name	Component Name	Component Percent	Percent Slope		Surface Texture <sup>1</sup>	Drainage Class <sup>2</sup>	Permeability <sup>3</sup>	Taxonomic Classification	Parent Material	Landforms
						Low	High						
St. Louis	MO189	60004	Menfro silt loam, 14 to 20 percent slopes, eroded	Menfro	90	14	20	SIL	W	MS	Fine-silty, mixed, superactive, mesic Typic Hapludalfs	Loess	Hills, hillslopes
St. Louis	MO189	60005	Menfro silt loam, 20 to 45 percent slopes	Menfro	89	20	45	SIL	W	MS	Fine-silty, mixed, superactive, mesic Typic Hapludalfs	Loess	Hills, hillslopes
St. Louis	MO189	60025	Urban land-Harvester complex, two to nine percent slopes	Urban Land	50	N/A	N/A	N/A	N/A	N/A	N/A	N/A	N/A
				Harvester	40	2	9	SIL	MW	MS	Fine-silty, mixed, superactive, nonacid, mesic Oxyaquic Udorthents	Loess	Hillslopes, interfluves
St. Louis	MO189	60165	Menfro silt loam, two to five percent slopes	Menfro	100	2	5	SIL	W	M	Fine-silty, mixed, superactive, mesic Typic Hapludalfs	Loess	Hillslopes
St. Louis	MO189	60171	Menfro silt loam, karst, two to 14 percent slopes, eroded	Menfro, karst	90	2	14	SIL	W	MS	Fine-silty, mixed, superactive, mesic Typic Hapludalfs	Loess	Hillslopes
St. Louis	MO189	60176	Menfro silt loam, karst, nine to 35 percent slopes	Menfro, karst	85	9	35	SIL	W	MS	Fine-silty, mixed, superactive, mesic Typic Hapludalfs	Loess	Hillslopes, sinkholes, ridges
St. Louis	MO189	60223	Urban land-Harvester complex, nine to 20 percent slopes	Urban Land	55	N/A	N/A	N/A	N/A	N/A	N/A	N/A	N/A
				Harvester	25	9	20	SIL	MW	MS	Fine-silty, mixed, superactive, nonacid, mesic Oxyaquic Udorthents	Loess	Hills, hillslopes
St. Louis	MO189	60224	Urban land-Harvester complex, karst, two to nine percent slopes	Urban Land, karst	60	N/A	N/A	N/A	N/A	N/A	N/A	N/A	N/A
				Harvester, karst	30	2	9	SIL	MW	MS	Fine-silty, mixed, superactive, nonacid, mesic Oxyaquic Udorthents	Loess	Interfluves, sinkholes, hillslopes
St. Louis	MO189	66024	Wilbur silt loam, zero to two percent slopes, frequently flooded	Wilbur	90	0	2	SIL	MW	M - MR	Coarse-silty, mixed, superactive, mesic Fluvaquentic Eutrudepts	Silty Alluvium	Flood plains, river valleys
St. Louis	MO189	99000	Pits, quarry	Pits, quarry	95	N/A	N/A	N/A	N/A	N/A	N/A	N/A	N/A
St. Louis	MO189	99001	Water	N/A	N/A	N/A	N/A	N/A	N/A	N/A	N/A	N/A	N/A

Notes:

- <sup>1</sup> Surface textures may include: silty clay (SIC), clay loam (CL), silty clay loam (SICL), silt loam (SIL), gravelly silt loam (GR-SIL), channery silt loam (CH-SIL), loam (L), gravelly loam (GR-L), fine sandy loam (FSL), sandy loam (SL), gravelly sandy loam (GR-SL), loamy fine sand (LFS), and extremely gravelly loamy coarse sand (GRX-LCOS). N/A - Not Applicable
- <sup>2</sup> Drainage classes may include: very poorly (VP), poorly (P), somewhat poorly (SP), moderately well (MW), well (W), somewhat excessively (SE), and excessively (E) drained. N/A-Not Applicable.
- <sup>3</sup> Permeability rates are based on the saturated hydraulic conductivity for the most limiting layer and may include: very rapid (VR), rapid (R), moderately rapid (MR), moderate (M), moderately slow (MS), slow (S), very slow (VS) and Impermeable (I).



## 7.2 Aboveground Facilities

No major aboveground facility sites greater than 5 acres in size are proposed for the Project.

Minor aboveground metering and regulating (“M&R”) facilities to be included as part of the Project include the Rockies Express Pipeline LLC (“REX”) Receipt Station and Laclede/Lange Delivery Station along the 24-inch pipeline, and the Chain of Rocks Station along North County Extension, a portion of which will be constructed adjacent to the existing Enable Mississippi River Transmission LLC (“Enable MRT”) Chain of Rocks facility. Soils crossed by the REX Receipt Station, Laclede/Lange Delivery Station, and the Chain of Rocks Station are shown in the table in Appendix 7-B, along with descriptions of the soil series. Additionally, the acres of soil characteristics affected by these facilities are provided in Table 7.3-1. Selected physical and interpretive characteristics of the soil map units crossed by the Project area are presented in Table 7.1-1.

Impacts to soils at the Chain of Rocks Station are expected to be minimal. Although the current land use is primarily forest and open land, the site is within property consisting of undeveloped former residential land. The paved driveway and some grassy lawn areas are still present on site, with stands of trees and brush. In addition, a portion of the facility is directly adjacent to an existing facility (Enable MRT Chain of Rocks). Much of the soils at this location are likely already partially disturbed, and will be permanently impacted by construction of the facility. Soils at the REX Receipt Station and Laclede/Lange Delivery Station are expected to be permanently impacted as a result of construction.

Other aboveground ancillary facilities along the Project will include the addition of three mainline valves (“MLVs”) installed along the proposed 24-inch pipeline. These facilities will be installed within the permanent easement. Each MLV site will consist of a 50-foot by 60-foot graveled area and will be fenced within the permanent easement. Additional information about these facilities can be found in Resource Report 1, Section 1.1.2.2 Aboveground Facilities. The soil characteristics affected by these facilities are included within the acreages provided in Table 7.3-1.

An impressed current cathodic protection system with remote groundbeds is proposed for the 24-inch pipeline and the North County Extension. Five remote groundbeds will be required for the 24-inch pipeline segment, and one remote groundbed is required for the North County Extension segment of the Project. Locations of these facilities are provided in Resource Report 1. The soil characteristics affected by these facilities are provided in Appendix 7-B and Table 7.3-1.

### 7.2.1 Access Roads

Soils crossed by the access roads associated with the Project are shown on the table in Appendix 7-B, along with descriptions of the soil series. Additionally, the acres of soil characteristics affected by these facilities are provided in Table 7.3-1.

Spire proposes to use and/or modify existing access roads to access the Project during construction and/or operation, with the exception of one new road, which will be only temporarily used for the Project. Those permanent access roads to be utilized during operation are current, existing roads and are therefore not expected to further impact soils as these soils are likely already disturbed. In order to minimize potential impacts of the



Project, public roads will be used to access the right-of-way where possible. To prevent sediment from tracking onto public roads by construction traffic, Spire will adhere to the recommended best management practices (“BMPs”) as specified by the applicable state and county agencies. Such BMPs typically include installation of stabilized construction entrances and additional erosion and sediment controls (“E&SCs”) as required at locations where vehicles will access a public road from the construction right-of-way. The majority of the access roads proposed for the Project are anticipated to be utilized temporarily. Following construction, temporary access roads will be restored to their preconstruction condition or allowed to remain in place in accordance with individual landowner agreements.

Further information on access roads is included in Resource Report 8, Table 8.1-4. Additional avoidance, minimization, and mitigation measures for the Project and its associated facilities are discussed in Section 7.3, Construction/Operation Impacts.

### **7.2.2 Staging Areas**

Soils crossed by the staging areas associated with the Project are shown in the table in Appendix 7-B, along with descriptions of the soil series. Additionally, the acres of soil characteristics affected by these facilities are included on Table 7.3-1.

Spire will utilize temporary staging areas in the vicinity of the Project for equipment and material storage, and contractor vehicle parking. These areas are shown on the Construction Alignment Sheets in Resource Report 1, Appendix 1-B. Spire anticipates grading and gravelling the existing land at each of the staging areas temporarily during construction. Upon completion of the Project, these areas will be restored and allowed to revert to prior uses. Additional avoidance, minimization, and mitigation measures for the Project and its associated facilities are discussed in Section 7.3, Construction/Operation Impacts.

## **7.3 Construction/Operation Impacts**

Construction activities that have the potential to adversely affect soils and revegetation potential within the Project area include clearing and grading, trenching, backfilling, and grading during restoration. Potential soil impacts include loss of soils due to water or wind erosion, especially on steep slopes or with fine sandy soils; reduction of soil quality by mixing topsoil with subsoil or by bringing excess rocks to the surface; soil compaction due to traffic by heavy equipment; and disruption of surface and subsurface drainage systems.



**Table 7.3-1. Acres of Soil Characteristics Affected by the Proposed Pipeline**

Facility/County, State <sup>1</sup>	Total Acres in County		Prime Farmland (acres) <sup>2</sup>		Farmland of Statewide Importance (acres) <sup>2</sup>		Hydric Soils (acres) <sup>2</sup>		Compaction Prone (acres) <sup>3</sup>		Highly Erodible				Revegetation Concerns (acres) <sup>6</sup>		Stony/ Rocky (acres) <sup>7</sup>		Shallow to Bedrock (acres) <sup>8</sup>	
	Temporary Impact	Permanent Impact	Temporary Impact	Permanent Impact	Temporary Impact	Permanent Impact	Temporary Impact	Permanent Impact	Temporary Impact	Permanent Impact	Water (acres) <sup>4</sup>		Wind (acres) <sup>5</sup>		Temporary Impact	Permanent Impact	Temporary Impact	Permanent Impact	Temporary Impact	Permanent Impact
											Temporary Impact	Permanent Impact	Temporary Impact	Permanent Impact						
<b>24-Inch Pipeline<sup>9</sup></b>																				
Scott County, Illinois	41.13	22.92	16.07	9.01	5.91	2.87	2.97	1.69	0.01	0.00	10.59	5.28	0.00	0.00	10.54	5.49	0.00	0.00	0.00	0.00
Greene County, Illinois	280.87	156.42	129.15	72.77	45.10	24.76	22.80	12.59	0.00	0.00	5.10	2.69	0.00	0.00	69.29	37.55	0.00	0.00	0.00	0.00
Jersey County, Illinois	173.82	97.53	83.15	46.36	38.17	21.39	15.82	8.93	0.03	0.00	21.12	11.09	0.00	0.00	56.24	30.69	1.55	1.01	0.00	0.00
St. Charles County, Missouri	133.49	77.34	71.09	39.31	0.00	0.00	59.20	34.83	41.66	23.61	0.00	0.00	0.00	0.00	0.65	0.34	0.00	0.00	0.00	0.00
St. Louis County, Missouri	6.67	4.47	0.00	0.00	2.17	1.30	0.00	0.00	0.00	0.00	0.05	0.01	0.00	0.00	2.21	1.31	0.00	0.00	0.00	0.00
<b>Subtotals<sup>10</sup></b>	<b>635.97</b>	<b>358.68</b>	<b>299.46</b>	<b>167.45</b>	<b>91.35</b>	<b>50.32</b>	<b>100.79</b>	<b>58.04</b>	<b>41.70</b>	<b>23.61</b>	<b>36.86</b>	<b>19.07</b>	<b>0.00</b>	<b>0.00</b>	<b>138.93</b>	<b>75.38</b>	<b>1.55</b>	<b>1.01</b>	<b>0.00</b>	<b>0.00</b>
<b>ATWS</b>																				
Scott County, Illinois	12.48	0.00	5.29	0.00	2.51	0.00	0.92	0.00	0.05	0.00	3.57	0.00	0.00	0.00	3.31	0.00	0.00	0.00	0.00	0.00
Greene County, Illinois	87.46	0.00	43.63	0.00	13.44	0.00	7.15	0.00	0.00	0.00	0.91	0.00	0.00	0.00	20.46	0.00	0.00	0.00	0.00	0.00
Jersey County, Illinois	49.28	0.00	24.93	0.00	10.12	0.00	4.39	0.00	0.09	0.00	4.55	0.00	0.00	0.00	13.80	0.00	1.44	0.00	0.00	0.00
St. Charles County, Missouri	56.35	0.00	29.01	0.00	0.00	0.00	27.34	0.00	19.92	0.00	0.00	0.00	0.00	0.00	0.22	0.00	0.00	0.00	0.00	0.00
St. Louis County, Missouri	3.92	0.00	0.00	0.00	2.05	0.00	0.00	0.00	0.00	0.00	0.88	0.00	0.00	0.00	2.93	0.00	0.00	0.00	0.00	0.00
<b>Subtotals<sup>10</sup></b>	<b>209.49</b>	<b>0.00</b>	<b>102.86</b>	<b>0.00</b>	<b>28.12</b>	<b>0.00</b>	<b>39.80</b>	<b>0.00</b>	<b>20.06</b>	<b>0.00</b>	<b>9.91</b>	<b>0.00</b>	<b>0.00</b>	<b>0.00</b>	<b>40.72</b>	<b>0.00</b>	<b>1.44</b>	<b>0.00</b>	<b>0.00</b>	<b>0.00</b>
<b>Cathodic Protection</b>																				
Greene County, Illinois	1.12	0.76	1.12	0.76	0.00	0.00	0.00	0.00	0.00	0.00	0.00	0.00	0.00	0.00	0.00	0.00	0.00	0.00	0.00	0.00
Jersey County, Illinois	0.41	0.27	0.17	0.11	0.09	0.06	0.00	0.00	0.00	0.00	0.00	0.00	0.00	0.00	0.09	0.06	0.00	0.00	0.00	0.00
St. Charles County, Missouri	0.41	0.28	0.41	0.28	0.00	0.00	0.00	0.00	0.00	0.00	0.00	0.00	0.00	0.00	0.00	0.00	0.00	0.00	0.00	0.00
<b>Subtotals<sup>10</sup></b>	<b>1.95</b>	<b>1.31</b>	<b>1.70</b>	<b>1.15</b>	<b>0.09</b>	<b>0.06</b>	<b>0.00</b>	<b>0.00</b>	<b>0.00</b>	<b>0.00</b>	<b>0.00</b>	<b>0.00</b>	<b>0.00</b>	<b>0.00</b>	<b>0.09</b>	<b>0.06</b>	<b>0.00</b>	<b>0.00</b>	<b>0.00</b>	<b>0.00</b>
<b>Access Roads</b>																				
Scott County, Illinois	0.73	0.10	0.35	0.09	0.01	0.01	0.00	0.00	0.00	0.00	0.01	0.01	0.00	0.00	0.01	0.01	0.00	0.00	0.00	0.00
Greene County, Illinois	4.16	0.00	1.01	0.00	1.50	0.00	0.00	0.00	0.00	0.00	0.00	0.00	0.00	0.00	2.07	0.00	0.00	0.00	0.00	0.00
Jersey County, Illinois	4.53	0.04	0.98	0.00	2.83	0.04	0.00	0.00	0.00	0.00	0.25	0.00	0.00	0.00	3.08	0.04	0.00	0.00	0.00	0.00
St. Charles County, Missouri	3.06	2.29	0.77	0.00	0.00	0.00	2.29	2.29	0.30	0.30	0.00	0.00	0.00	0.00	0.00	0.00	0.00	0.00	0.00	0.00
St. Louis County, Missouri	2.13	0.00	0.00	0.00	0.00	0.00	0.00	0.00	0.00	0.00	0.00	0.00	0.00	0.00	0.00	0.00	0.00	0.00	0.00	0.00
<b>Subtotals<sup>10</sup></b>	<b>14.61</b>	<b>2.43</b>	<b>3.11</b>	<b>0.09</b>	<b>4.34</b>	<b>0.05</b>	<b>2.29</b>	<b>2.29</b>	<b>0.30</b>	<b>0.30</b>	<b>0.26</b>	<b>0.01</b>	<b>0.00</b>	<b>0.00</b>	<b>5.16</b>	<b>0.05</b>	<b>0.00</b>	<b>0.00</b>	<b>0.00</b>	<b>0.00</b>
<b>Subtotals for 24-Inch Pipeline<sup>10</sup></b>	<b>862.02</b>	<b>362.42</b>	<b>407.13</b>	<b>168.69</b>	<b>123.90</b>	<b>50.43</b>	<b>142.88</b>	<b>60.33</b>	<b>62.06</b>	<b>23.91</b>	<b>47.03</b>	<b>19.08</b>	<b>0.00</b>	<b>0.00</b>	<b>184.90</b>	<b>75.49</b>	<b>2.99</b>	<b>1.01</b>	<b>0.00</b>	<b>0.00</b>
<b>North County Extension</b>																				
<b>Pipeline</b>																				
St. Louis County, Missouri	59.41	36.54	8.52	5.05	33.11	19.06	0.00	0.00	0.00	0.00	29.44	18.26	0.00	0.00	44.55	27.37	0.00	0.00	0.00	0.00
<b>ATWS</b>																				
St. Louis County, Missouri	30.25	0.00	2.27	0.00	23.17	0.00	0.00	0.00	0.00	0.00	18.48	0.00	0.00	0.00	25.54	0.00	0.00	0.00	0.00	0.00



**Table 7.3-1. Acres of Soil Characteristics Affected by the Proposed Pipeline (Continued)**

Facility/County, State <sup>1</sup>	Total Acres in County		Prime Farmland (acres) <sup>2</sup>		Farmland of Statewide Importance (acres) <sup>2</sup>		Hydric Soils (acres) <sup>2</sup>		Compaction Prone (acres) <sup>3</sup>		Highly Erodible				Revegetation Concerns (acres) <sup>6</sup>		Stony/ Rocky (acres) <sup>7</sup>		Shallow to Bedrock (acres) <sup>8</sup>	
	Temporary Impact	Permanent Impact	Temporary Impact	Permanent Impact	Temporary Impact	Permanent Impact	Temporary Impact	Permanent Impact	Temporary Impact	Permanent Impact	Water (acres) <sup>4</sup>		Wind (acres) <sup>5</sup>		Temporary Impact	Permanent Impact	Temporary Impact	Permanent Impact	Temporary Impact	Permanent Impact
											Temporary Impact	Permanent Impact	Temporary Impact	Permanent Impact						
<b>North County Extension (continued)</b>																				
<i>Catholic Protection</i>																				
St. Louis County, Missouri	0.45	0.30	0.11	0.07	0.34	0.22	0.00	0.00	0.00	0.00	0.02	0.00	0.00	0.00	0.34	0.22	0.00	0.00	0.00	0.00
<i>Access Roads</i>																				
St. Louis County, Missouri	2.35	0.00	0.00	0.00	0.35	0.00	0.00	0.00	0.00	0.00	0.35	0.00	0.00	0.00	1.16	0.00	0.00	0.00	0.00	0.00
<b>Subtotals for North County Extension<sup>10</sup></b>	<b>92.46</b>	<b>36.84</b>	<b>10.90</b>	<b>5.12</b>	<b>56.97</b>	<b>19.28</b>	<b>0.00</b>	<b>0.00</b>	<b>0.00</b>	<b>0.00</b>	<b>48.29</b>	<b>18.26</b>	<b>0.00</b>	<b>0.00</b>	<b>71.59</b>	<b>27.59</b>	<b>0.00</b>	<b>0.00</b>	<b>0.00</b>	<b>0.00</b>
<b>Aboveground Facilities</b>																				
<i>REX Receipt Station</i>																				
Scott County, Illinois	5.02	5.02	3.81	3.81	1.20	1.20	0.00	0.00	0.00	0.00	1.20	1.20	0.00	0.00	1.20	1.20	0.00	0.00	0.00	0.00
<i>Laclede/Lange Delivery Station</i>																				
St. Louis County, Missouri	3.99	3.99	0.00	0.00	3.99	3.99	0.00	0.00	0.00	0.00	0.00	0.00	0.00	0.00	3.99	3.99	0.00	0.00	0.00	0.00
<i>Chain of Rocks Station</i>																				
St. Louis County, Missouri	7.51	6.97	2.32	2.32	2.64	2.10	2.55	2.55	2.55	2.55	2.64	2.10	0.00	0.00	2.64	2.10	0.00	0.00	0.00	0.00
<b>Subtotals for Aboveground Facilities<sup>10</sup></b>	<b>16.52</b>	<b>15.98</b>	<b>6.13</b>	<b>6.13</b>	<b>7.83</b>	<b>7.29</b>	<b>2.55</b>	<b>2.55</b>	<b>2.55</b>	<b>2.55</b>	<b>3.84</b>	<b>3.30</b>	<b>0.00</b>	<b>0.00</b>	<b>7.83</b>	<b>7.29</b>	<b>0.00</b>	<b>0.00</b>	<b>0.00</b>	<b>0.00</b>
<b>Staging Areas</b>																				
Scott County, Illinois	27.82	0.00	8.21	0.00	14.67	0.00	0.00	0.00	0.00	0.00	14.67	0.00	0.00	0.00	14.67	0.00	0.00	0.00	0.00	0.00
Jersey County, Illinois	2.83	0.00	2.64	0.00	0.19	0.00	0.00	0.00	0.00	0.00	0.00	0.00	0.00	0.00	0.19	0.00	0.00	0.00	0.00	0.00
St. Charles County, Missouri	2.87	0.00	1.43	0.00	0.00	0.00	1.44	0.00	1.44	0.00	0.00	0.00	0.00	0.00	0.00	0.00	0.00	0.00	0.00	0.00
<b>Subtotals for Staging Areas<sup>10</sup></b>	<b>33.52</b>	<b>0.00</b>	<b>12.28</b>	<b>0.00</b>	<b>14.86</b>	<b>0.00</b>	<b>1.44</b>	<b>0.00</b>	<b>1.44</b>	<b>0.00</b>	<b>14.67</b>	<b>0.00</b>	<b>0.00</b>	<b>0.00</b>	<b>14.86</b>	<b>0.00</b>	<b>0.00</b>	<b>0.00</b>	<b>0.00</b>	<b>0.00</b>
<b>Totals<sup>10</sup></b>	<b>1004.52</b>	<b>415.24</b>	<b>436.44</b>	<b>179.94</b>	<b>203.56</b>	<b>77.00</b>	<b>146.87</b>	<b>62.88</b>	<b>66.05</b>	<b>26.46</b>	<b>95.35</b>	<b>40.64</b>	<b>0.00</b>	<b>0.00</b>	<b>279.18</b>	<b>110.37</b>	<b>2.99</b>	<b>1.01</b>	<b>0.00</b>	<b>0.00</b>

Notes:

- <sup>1</sup> Area affected includes the construction right-of-way and additional temporary workspace. Excluding the total acres fields, the soils data in the table does not include areas of open water.
- <sup>2</sup> As designated by the NRCS. Prime farmland does not include those soils that are considered prime if artificial drainage is implemented.
- <sup>3</sup> Includes soils in somewhat poor to very poor drainage classes with surface textures of sandy clay loam and finer.
- <sup>4</sup> Land in capability subclasses 4E through 8E and soils with an average slope greater than or equal to nine percent.
- <sup>5</sup> Soils with a wind erodibility group classification of 1 or 2.
- <sup>6</sup> Soils with a surface texture of sandy loam or coarser and are moderately well to excessively drained and soils with an average slope greater than or equal to nine percent.
- <sup>7</sup> Includes soils with a cobbley, stony, boulder, shaly, gravelly, very gravelly, or extremely gravelly modifier to the textural class of the surface layer.
- <sup>8</sup> Soils identified as containing bedrock at a depth of 5 feet or less from the surface.
- <sup>9</sup> Mainline valves are located within the permanent easement associated with the 24-Inch Pipeline.
- <sup>10</sup> May not equal the sum of the column due to rounding.





To minimize or avoid impacts on soils, Spire will implement the Federal Energy Regulatory Commission (“FERC”) *Upland Erosion Control, Revegetation, and Maintenance Plan* (“Plan”) and FERC’s *Wetland and Waterbody Construction and Mitigation Procedures* (“Procedures”) (May 2013), as well as applicable state and local regulations during construction and operation of the Project. Deviations from the Plan and Procedures are described in Resource Report 1, Appendix 1-D Exceptions to the FERC Plan and Procedures.

Additionally, in conjunction with the Illinois Department of Agriculture (“IDOA”), Spire has developed a Project-specific Agricultural Impact Mitigation Agreement (“AIMA”) which incorporates the Illinois Pipeline Construction Standards and Policies for the portions of the Project in Illinois. Spire executed the AIMA with the IDOA in March 2017. The agreement is provided in Appendix 7-C.

Appendix 7-B and Table 7.3-1 provide information regarding soil limitations for the Project. The primary soil limitations identified along the Project route are erosion hazard, compaction prone, revegetation concerns, potential for introduction of stones and rocks into topsoil, shallow bedrock, prime or unique farmland or farmland of statewide importance and hydric soils.

### **7.3.1 Erosion Hazard**

Soil erosion is a continuing process that can be accelerated by human disturbances. Soil erosion potential is affected by the soil lithology, including mineralogy, grain size, texture and organic content. Soil erosion potential is influenced by slope and exposure to erosion mechanisms. Soil erosion increases in inverse proportion to the effectiveness of vegetation cover (i.e., soils with denser vegetation cover are less susceptible to erosion). Removal of vegetation associated with construction activities, whether by direct stripping or by other mechanical means, greatly increases erosion potential. The classification of a soil as highly erodible by the USDA-NRCS is directly related to the soil’s susceptibility to erosion by water or wind. Soils that are classified as having high erosion potential can be highly erodible but do not always exhibit this condition because of the multitude of parameters that require evaluation such as soil texture, structure, length and percent of slope, vegetative cover, and rainfall or wind intensity. Typically, field determinations of the length of slope class crossed are needed before a soil can be definitively identified as having high erosion potential.

Table 7.3-1 provides the total acreage of soil potentially crossed by the Project that is characterized as having a high potential for erosion by water; soil characterized by having a high potential for erosion by wind is not crossed by the Project. The soils crossed by the proposed Project route that have a high potential for erosion by water are also included by MP in Appendix 7-B. Mitigation and minimization measures are discussed in Section 7.5, Mitigation.

### **7.3.2 Compaction Prone**

Soils with a high potential for compaction will be affected during construction activities through the repeated movement of machinery across the soil surface as well as from the staging of materials. Soils with high shrink-swell potential and poor drainage characteristics tend to be susceptible to compaction, particularly when wet. These soils tend to have high clay content composed of platy particles with water in interstitial spaces. Clay particles will become compacted through repeated stress. Soils with a high silt or sand content tend to be composed of sub-rounded to rounded particles, and are less compactable. Although surface “crusts” may form



on these types of soils when subjected to repeated traffic, upon drying, the compacted particles are often readily separated. Formation of hardpan is a potential result of repeated traffic over susceptible soils. The formation of hardpan is typically limited to soils with high to very high shrink-swell potential. Hardpan layers tend to form at horizons where there is a significant physical or chemical change in the subsoil, often between the A and B or B and C horizons. Hardpans related to artificial compaction tend to form at relatively shallow depth where mechanical stress is not effectively dissipated by the overlying soil column. Hardpans also commonly form at the base of the plow zone where a change in the soil porosity and permeability may cause perching of water and subsequent physical and chemical changes resulting in the formation of a hardpan.

Table 7.3-1 provides the total acreage of soil potentially crossed by the Project that is characterized as having a high potential for compaction. The soils potentially crossed by the proposed Project route that have a high potential for compaction are included by MP in Appendix 7-B. Mitigation and minimization measures are discussed in Section 7.5, Mitigation.

### **7.3.3 Revegetation Concerns**

Soils with low revegetation potential typically have high compaction and/or erosion potentials, have greater slopes, and are not classified as prime farmland. Low potential for revegetation within the Project is primarily attributed to soil conditions such as soil compaction. The revegetation potential was described as having the following soil characteristics: coarse textured soils (sandy loams and coarser) that are moderately well to excessively drained and soils with an average slope greater than or equal to nine percent.

The soils crossed by the proposed Project route that are described as having a low revegetation potential are provided by MP in Appendix 7-B. Additionally, Table 7.3-1 includes the total acreage of soil potentially crossed by the Project that is characterized as having a low revegetation potential, which is primarily attributable to slope. Mitigation and minimization measures are discussed in Section 7.5, Mitigation.

### **7.3.4 Potential for Introduction of Stones and Rocks into Topsoil**

According to the United States Department of Agriculture, Natural Resource Conservation Service Web Soil Surveys for Greene, Jersey and Scott Counties, Illinois and St. Charles and St. Louis Counties, Missouri, the Project is not anticipated to cross soils considered “shallow to bedrock” (i.e., soils identified as containing bedrock at a depth of 5 feet or less from the surface) (2015a and 2015b).

Given that soils considered shallow to bedrock do not encompass the Project route, the removal of rock from the trench (both consolidated and unconsolidated), is not anticipated. The extraction of rock from the trenchline increases the potential for introduction of rock into the topsoil layer, however this is not expected to occur.

Should soils considered shallow to bedrock be encountered, at a minimum, Spire will implement FERC’s Plan and Procedures to minimize and mitigate the potential for stones and rocks to be introduced into the topsoil as a result of Project construction. Additional mitigation and minimization measures are discussed in Section 7.5, Mitigation.



### 7.3.5 Prime or Unique Farmland or Farmland of Statewide Importance

Prime farmland is a special classification of highly productive cropland that is recognized and described by the USDA-NRCS. Prime farmland soils are defined by the USDA-NRCS as land with the best combination of physical and chemical characteristics for producing food, feed, forage, fiber and oilseed crops (USDA-NRCS 2000).

The total acreages of Prime Farmland and Farmland of Statewide Importance both temporarily and permanently proposed to be impacted by the Project are provided in Table 7.3-1. According to the USDA-NRCS WSS database, the total combined acreage of Prime Farmland and Farmland of Statewide Importance for all five counties (Scott, Greene, and Jersey counties, Illinois and St. Charles and St. Louis Counties, Missouri) is approximately 316,763 acres of Prime Farmland and approximately 282,824 acres of Farmland of Statewide Importance. The Project potentially temporarily and/or permanently impacts less than one percent of the total combined acreage of Prime Farmland and less than one percent of the total combined acreage of Farmland of Statewide Importance. Of this less than one percent, the following Project facilities have temporary and/or permanent impacts to Prime Farmland or Farmland of Statewide Importance:

- The 24-inch pipeline and North County Extension are anticipated to temporarily and permanently impact Prime Farmland and Farmland of Statewide Importance.
- The REX Receipt Station and Chain of Rocks Station are anticipated to temporarily and permanently impact Prime Farmland and Farmland of Statewide Importance.
- The Laclede/Lange Delivery Station is anticipated to temporarily and permanently impact Farmland of Statewide Importance.
- Cathodic protection in Greene, Jersey, St. Charles, and St. Louis Counties is anticipated to temporarily and permanently impact Prime Farmland, and cathodic protection in Jersey and St. Louis Counties is also anticipated to temporarily and permanently impact Farmland of Statewide Importance.
- Staging areas in Scott, Jersey, and St. Charles Counties are anticipated to temporarily impact Prime Farmland, with no permanent impacts to Prime Farmland anticipated, and staging areas in Scott and Jersey Counties are anticipated to temporarily impact Farmland of Statewide Importance, with no permanent impacts to Farmland of Statewide Importance anticipated.
- Access roads in Scott, Greene, Jersey, and St. Charles Counties are anticipated to temporarily impact Prime Farmland, with anticipated permanent impacts to Prime Farmland in Scott County.
- Access roads in Scott, Greene, Jersey, and St. Louis Counties are anticipated to temporarily impact Farmland of Statewide Importance, with anticipated permanent impacts to Farmland of Statewide Importance in Scott and Jersey Counties.

Construction of the Project is considered temporary in nature and workspaces will be returned to agricultural land use upon completion of construction. Spire will work with landowners to accommodate farm access during construction of the Project. Spire will compensate landowners for damages and crop loss as a result of construction and operation.

Spire will minimize temporary impacts to this land classification through the use the FERC Plan and the Project-specific AIMA for Illinois. In order to avoid and minimize affects to topsoil, Spire proposes to perform topsoil



segregation in active croplands across the entire right-of-way and associated additional temporary workspace (“ATWS”). Implementation of proper topsoil segregation will help ensure post-construction revegetation success, thereby minimizing loss of crop productivity and the potential for long-term erosion problems. In order to minimize compaction, Spire will limit traffic on off-road areas to only those required to accomplish construction activities. Following completion of construction, areas of heavy compaction will be tilled as necessary when soil moisture conditions are suitable. As described in FERC’s Plan, a minimum of 12 inches of topsoil will be segregated in deep soils and the entire topsoil layer, where possible, will be segregated in soils with less than 12 inches of topsoil. It is anticipated that Spire will encounter greater than 12 inches of topsoil in Illinois, which will be determined during construction by a qualified soil scientist in accordance with the AIMA. The topsoil and subsoil will be temporarily stockpiled in separate windrows on the construction right-of-way. Additional workspace for topsoil segregation may be requested as necessary. Refer to Resource Report 1, Section 1.3.1.2 Special Construction Procedures for additional information regarding special construction procedures in active croplands.

Spire is proposing five feet of cover in croplands in both Illinois and Missouri which would allow sufficient depth for landowners to continue agricultural practices. In addition, Spire will coordinate with landowners and local agencies, as appropriate, to identify agricultural drainage systems. Spire will repair drain tile systems damaged as a result of the construction of the Project. Spire proposes to refer to the FERCS’ Plan to identify and minimize interference with drain tile and irrigation systems.

A majority of the soils located within aboveground facilities are not classified as prime farmland. The total acreage of prime farmland anticipated to be permanently impacted (i.e., converted to developed uses) by the Project is provided in Table 7.3-1. Spire will compensate landowners for the loss of land permanently out of production for agricultural uses.

### **7.3.6 Hydric Soils**

The proposed Project will cross areas of hydric soils. Table 7.3-1 provides the total acreage of soil potentially crossed by the Project that is classified as predominantly hydric or hydric soil. Due to extended periods of saturation, hydric soils can be susceptible to compaction and rutting.

At a minimum, Spire will implement FERC’s Plan and Procedures to minimize and mitigate impacts to hydric soils. Grading to restore the original contour as well as repair of rutting areas will be completed prior to revegetation. Additionally, Spire has routed the Project to avoid and minimize impacts to wetlands where possible. In areas where the Project crosses wetlands, Spire intends to reduce its right-of-way width to 75 feet where possible. Timber mats will be used to minimize rutting and compaction within saturated wetlands.

The proposed Chain of Rocks Station on the North County Extension in St. Louis County is partially located within the limits of the Mississippi River FEMA 100-year flood zone, though not within the regulated floodway. A small area (less than 0.05 acre) will be fenced and permanently graveled within the LGC previously disturbed right-of-way adjacent to the Enable Mississippi River Transmission, LLC Chain of Rocks Station; the fenced and graveled area is within the limits of the floodplain. If necessary, Spire will perform a hydrologic and hydraulic analysis for construction of this facility as part of the permit submittals. This is further discussed in Resource Report 2, Section 2.2.3 Floodplains.



## 7.4 Consultations

### 7.4.1 Illinois

Spire consulted with the appropriate agencies regarding potential impacts to soils crossed by the Project. Spire initiated consultation and met with the IDOA in June 2016 to introduce the Project and discuss development of the AIMA. The AIMA was executed with the IDOA in March 2017. The agreement is provided in Appendix 7-C. Spire initiated a request of information from the Scott, Greene and Jersey County Soil and Water Conservation District (“SWCDs”) in September 2016, regarding recommendations for seed mixes, seeding dates, and restoration and/or seeding plans. Each county indicated that the USDA-NRCS technical guide can be utilized for suggested seed mixes (Behymer 2016 and Mueller 2016).

Spire has consulted with USDA Farm Service Agency (“FSA”) in Illinois and confirmed that the 24-inch pipeline will cross lands enrolled in the conservation reserve program (“CRP”) (Diebal 2016 and Diebal 2017). The CRP program is a land conservation program facilitated by the FSA with the long-term goal being to re-establish valuable land cover to help improve water quality, prevent soil erosion and reduce loss of wildlife habitat (United States Department of Agriculture, Farm Service Agency). Information regarding the specific tracts of CRP lands crossed by the Project is not able to be provided directly to Spire by the FSA; therefore, letters were sent by the Illinois FSA to each of the owners of the CRP lands crossed by the Project. Landowners then coordinated with Spire to indicate which tracts or portions of tracts enrolled in CRP lands would be temporarily affected by the Project. Spire communicated with the landowners of known CRP lands regarding particular seeding plans for these areas. Further information on these properties is provided in Resource Report 8, Table 8.3-1. Seed mixes to address each of the conservation program tracts are provided below in Table 7.4-1.

### 7.4.2 Missouri

Spire requested information from the Missouri USDA-NRCS and the St. Charles and St. Louis Counties SWCDs regarding recommendations for seed mixes, seeding dates, and restoration and/or seeding plans. The Missouri USDA-NRCS and SWCDs indicated the NRCS technical guide can be utilized for suggested seed mixes (Cook 2016).

Spire has consulted with USDA FSA in Missouri and confirmed that there are no CRP lands crossed by the Project in Missouri (Gibson 2016 and Niemeyer 2017).



**Table 7.4-1. Seed Mixes Associated with Conservation Program Tracts**

Approximate MP	CRP Contract #	County, State	Type of Conservation Program	Special Seed Mix, Construction, or Restoration Techniques
0.0, 3.3, and 3.8	-	Scott, Illinois	CRP	Project is not expected to impact CRP land per discussions with landowner.
0.7, 1.1, 1.3, and 1.5	-	Scott, Illinois	CRP	Project is not expected to impact CRP land per discussions with landowner.
2.9	-	Scott, Illinois	CRP	Project is not expected to impact CRP land per discussions with landowner.
3.1	-	Scott, Illinois	CRP	Discussions continuing with landowner.
10.4	11192	Greene, Illinois	CRP	Seed mix consistent with seed pollinator program to be provided by landowner.
22.6	HEL TRACT #1715	Greene, Illinois	Highly Erodible Soils	Rye mix to be applied in the fall.
27.3	796	Greene, Illinois	CRP	Forbes and warm season grasses.
42.4	11109	Jersey, Illinois	CRP	Tall Fescue: 30 lbs/acre; Timothy: 8 lbs/acre; Red Clover: 8 lbs/acre; Oats: 32 lbs/acre; Nitrogen: 120 lbs/acre; Phosphorous: 120 lbs/acre; Potassium: 120 lbs/acre; Wheat: 5lbs/acre; Straw: 2 tons/acre; Lime: as needed; 'No till' property.
43.5	-	Jersey, Illinois	Highly Erodible Soils	Discussions continuing with landowner.

The 24-inch pipeline will cross one property owned by the United States Army Corps of Engineers (“USACE”) St. Louis District on the south side of the Mississippi River which will require a right-of-easement from the USACE. The property is jointly managed with the Missouri Department of Conservation (“MDOC”). No earth disturbance on this property is anticipated as this property would be encompassed as part of Spire’s trenchless crossing of the Mississippi River. Workspaces associated with the crossing of the Mississippi River have been located outside the boundaries of this property. Trenchless crossing of this property would avoid direct impacts to soil and vegetation from construction of the Project as Spire does not intend to clear or maintain vegetation in between the horizontal directional drill entry/exit points.



## 7.5 Mitigation

To mitigate potential impacts to soils associated with the Project, Spire will implement the FERC Plan and Procedures, as well as state and local regulations, requirements and/or guidance provided by applicable permitting agencies during construction and operation of the Project. Where deviations from the Plan and Procedures are necessary for site-specific reasons, these locations are identified in Resource Report 1, Appendix 1-D Exceptions to the FERC Plan and Procedures.

Techniques to be used to mitigate potential impacts to soil will be described in detail in the Project's Erosion and Sediment Control Plan ("E&SCP"). Spire will obtain the necessary Erosion and Sediment Control Permits prior to commencement of construction.

Spire will refer to the USDA-NRCS guidelines for Critical Area Planting for seed mixes and planting methods appropriate for the establishment of permanent vegetation on non-cropland sites that have or are expected to have high erosion rates or other conditions that prevent the establishment of vegetation with normal practices. As described in the Critical Area Planting guidelines, Spire will include the following measures:

- No plants on the state noxious weeds lists will be planted.
- Site preparation and seeding or planting will be done at a time and manner that best ensures survival and growth of the selected species.
- Fertilization, mulching or other facilitating practices for plant growth will be timed and applied to accelerate the establishment of the selected species.
- Planting dates will be scheduled during approved dates for the species and to optimize soil moisture for germination and establishment.
- Species selected will be suited to the current site conditions and intended uses (NRCS 2015).

Additional information regarding seed mixes is provided in Section 7.5.4.

### 7.5.1 Soil Erosion

Spire will detail various techniques to control soil erosion in the E&SCP. Spire intends to implement FERC's Plan and Procedures as a minimum standard during construction. Spire will implement BMPs during and after construction to minimize erosion of disturbed soils and prevent the transportation of sediment outside of the construction right-of-way. Spire proposes to install temporary erosion controls where applicable immediately after the initial disturbance of the soil. Temporary erosion control measures Spire may employ during construction include the use of temporary slope breakers, temporary trench plugs, sediment barriers and/or mulch. Temporary erosion controls will be properly maintained throughout construction and reinstalled as necessary until replaced by permanent erosion controls or restoration is complete. Additionally, Spire will implement the following:

- An Environmental Inspector will monitor all phases of Project construction to ensure measures detailed in the E&S Plan will be followed.



- Construction staff will undergo environmental training for techniques detailed in the E&SCP.

### **7.5.2 Soil Compaction**

During construction, there is the potential for increased runoff of stormwater as a result of compacted soils from construction vehicles and staging of materials. At a minimum, Spire will implement FERC's Plan and Procedures to minimize and mitigate impacts to soils that are considered compaction prone. To the extent practicable, Spire will avoid construction during periods of heavy rainfall and snow melt. Grading to restore the approximate original contour as well as repair of rutted areas will be completed prior to final revegetation, seeding and mulching. Agricultural or residential locations found to be subjected to compaction will be decompacted with deep tillage by devices such as a deep-shank subsoiler, a heavy-duty ripping chisel or ripping chisel-plow, Paraplow®, Paratill®, or other landowner-specified techniques. Subsoils being decompacted will typically be ripped to a depth of 18 to 22 inches. Large stones unearthed during the decompaction process will be removed from the area prior to replacing topsoil. Care will be taken to not mix topsoil and subsoil during decompaction.

### **7.5.3 Introduction of Rock into Topsoil**

As discussed in Spire's AIMA, the following rock removal procedures only pertain to rocks found in the uppermost 42 inches of soil, the common freeze zone in Illinois. Before replacing any topsoil, all rocks greater than three inches in any dimension will be removed from the surface of all exposed subsoil and from all subsoil that is replaced back in the trench. The size, density and distribution of rock on the right-of-way shall be similar to adjacent areas not disturbed by construction. As the topsoil is replaced, all rocks greater than three inches in any dimension will be removed from the topsoil until conditions on the right-of-way are similar compared to the adjacent off right-of-way are achieved. If trenching, blasting, or boring operations are required through rocky terrain, suitable precautions will be taken to minimize the potential for oversized rocks to become interspersed with adjacent soil material. Rocks and soil containing rocks removed from the subsoil areas, topsoil, or from any excavations, will be hauled off the landowner's premises or disposed of on the landowner's premises at a location that is mutually acceptable to the landowner and Spire. Haul off and/or disposal locations cannot conflict with Spire's FERC-Certificated workspace allowance.

### **7.5.4 Post-Construction Revegetation**

Successful restoration and revegetation of the Project's workspaces are important for maintaining productivity and protecting the underlying soil from potential damage. At a minimum, Spire will implement FERC's Plan and Procedures to minimize and mitigate the impact to soils characterized as having potential revegetation concerns. Spire proposes to ensure successful revegetation of soils disturbed by the Project in accordance with FERC's Plan. Consultations with these agencies is further discussed in Section 7.4, Consultations.

Fertility and erosion are generally the two main factors that would limit the re-growth of vegetation, but these can be mitigated through the application of fertilizers and/or seeding nets. Spire will apply soil amendments in areas with poor to moderate revegetation potential in order to create a favorable environment for the re-establishment of vegetation. Additionally, based on the characteristics of the Project areas, Spire has developed seed mixes that will be applied based on site specific conditions including soil types, topography, native plant





communities, and land uses. Three main areas (outside of cultivated agricultural lands) were identified along the Project that may require specialized seed mixes based on site conditions; forested uplands, forested lowlands and non-agricultural meadowlands. Forested uplands include non-cultivated areas with rolling topography that consist of predominately deciduous trees, native understory shrubs and grasses, and steep slopes of greater than 35 percent. Forested lowlands consist of areas that are frequently in close proximity to floodplain and riparian areas and consist of predominately deciduous trees with native understory shrubs, facultative/facultative wetland grasses, and slopes of less than 10 percent. Non-agricultural meadowlands include non-forested lands with minimal changes in topography and consist of predominately native and introduced grasses.

Native grass seed mixes are preferred for revegetation efforts on disturbed lands because they have adapted to local environments giving longevity to successful revegetation efforts. Revegetation using native species provides a diverse vegetative community and habitat for inherent wildlife, improves soil stability, encourages biodiversity, and deters the introduction of noxious and/or invasive species. Native grass species are also less likely to be invasive or overly competitive with adjacent plants or crops.

Each native seed mix type for each type of area identified along the Project (outside of cultivated agricultural land) was developed using 60 pure live seed (“PLS”) per square foot and was developed in consultation with regional USDA-NRCS technical guidelines.

In addition, a nurse crop (annual rye) will also be considered to be added to the native seed mixes at any time of the year to provide quick vegetation establishment and ground cover. These annuals are applied at lower rates, 4.0 pounds per acre, such that competition with the native species is avoided.

**Table 7.5-1. Recommended Forested Upland Seed Mix**

Common Name	Scientific Name	# PLS/acre	PLS/sq ft	Percent of Mix
Little Bluestem	<i>Schizachyrium scoparium</i>	2.0	12.0	20
Sideoats Grama	<i>Bouteloua curtipendula</i>	2.7	12.0	20
Switchgrass	<i>Panicum virgatum</i>	1.0	9.0	15
Blue Grama	<i>Bouteloua gracilis</i>	0.48	9.0	15
Canada Wildrye	<i>Elymus canadensis</i>	3.4	9.0	15
Rough Dropseed	<i>Sporobolus clandestinus</i>	0.52	9.0	15
<b>Totals</b>		<b>10.2</b>	<b>60.0</b>	<b>100</b>



**Table 7.5-2. Recommended Forested Lowland Seed Mix**

Common Name	Scientific Name	# PLS/acre	PLS/sq ft	Percent of Mix
Big Bluestem	<i>Andropogon gerardii</i>	4.0	12.0	20
Indiangrass	<i>Sorghastrum nutans</i>	3.4	12.0	20
Switchgrass	<i>Panicum virgatum</i>	1.0	9.0	15
Prairie Cordgrass	<i>Spartina pectinata</i>	0.87	3.0	5
Canada Wildrye	<i>Elymus canadensis</i>	4.6	12.0	20
Virginia Wildrye	<i>Elymus virginicus</i>	7.1	12.0	20
<b>Totals</b>		<b>20.9</b>	<b>60.0</b>	<b>100</b>

**Table 7.5-3. Recommended Non-Agriculture Meadow Seed Mix**

Common Name	Scientific Name	# PLS/acre	PLS/sq ft	Percent of Mix
Indiangrass	<i>Sorghastrum nutans</i>	3.4	12.0	20
Big Bluestem	<i>Andropogon gerardii</i>	4.0	12.0	20
Little Bluestem	<i>Schizachyrium scoparium</i>	1.5	9.0	15
Sideoats Grama	<i>Bouteloua curtipendula</i>	2.1	9.0	15
Switchgrass	<i>Panicum virgatum</i>	1.0	9.0	15
Virginia Wildrye	<i>Elymus virginicus</i>	5.3	9.0	15
<b>Totals</b>		<b>17.3</b>	<b>60.0</b>	<b>100</b>

Pollinator seed mixes were also developed to be incorporated into native grass seed mixes upon specific landowner request. Pollinator vegetation species are known to be good pioneering species, especially when provided native bunchgrass communities to establish within. The pollinator mixes are only intended to be utilized if requested by landowners. The use of pollinator species in a seed mix reduces noxious weed management options since herbicides would impede the establishment of pollinator species. Spire does not propose to utilize herbicides along the permanent easement with the exception of at its proposed aboveground facilities in Illinois in accordance with the AIMA in Illinois. Herbicide use will be conducted by an applicator licensed in the state of Illinois. To minimize the potential for the introduction of noxious weed and invasive species seeds Spire has prepared a Noxious Weed/Invasive Plant Control and Mitigation Plan, included in Resource Report 3, Appendix 3-A. Implementation of this Plan will minimize the spread of noxious and invasive plant species. Measures will be taken (as described in Resource Report 3) to control the spread of noxious weeds during construction. If species or colonies are found during monitoring in numbers which are significantly different from the existing nearby off right-of-way locations, Spire will mow and/or hand clear the noxious weeds.



The following seed mix has been developed and can be incorporated into the native seed mix in any of the three areas.

**Table 7.5-4. Recommended Supplemental Pollinator Seed Mix**

Common Name	Scientific Name	# PLS/acre	PLS/sq ft	Percent of Mix
Illinois Bundleflower	<i>Desmanthus illinoensis</i>	1.3	2.5	25
Purple Prairie Clover	<i>Dalea purpurea</i>	0.52	2.5	25
Partridge Pea	<i>Chamaecrista fasciculata</i>	1.8	2.5	25
Purple Coneflower	<i>Echinacea purpurea</i>	0.94	2.5	25
<b>Totals</b>		<b>4.5</b>	<b>10.0</b>	<b>100</b>

The optimal seeding time for native grasses is between spring from April 15 through May 15 and August 1 through September 20. Dormant seeding should occur between November 15 and March 1. Although these are optimal seeding dates, native seeding can be performed throughout the year; however seeding outside the seeding window may reduce the reclamation success. If native grasses are not planted, a cover crop seed mix may be utilized between May 15 and August 1 (NRCS 2002).

**Table 7.5-5. Recommend Cover Crop Seed Mixes**

State/Common Name	Scientific Name	# PLS/acre	PLS/sq ft	Percent of Mix
Japanese Millet	<i>Echinochloa esculenta</i>	11.5	34.0	85
Crimson Clover	<i>Trifolium incarnatum</i>	1.3	4.0	10
Oilseed Radish	<i>Raphanus sativus var. Longipinnatus</i>	2.8	2.0	5
<b>Totals</b>		<b>15.6</b>	<b>40.0</b>	<b>100</b>

Seedbed preparation will aid in successful revegetation. Subsurface soil will be ripped prior to topsoil application to reduce soil compaction and improve drainage. Soil amendments will be added to the topsoil as necessary based on soil test results and where less than ideal soil conditions and low plant available nutrients are identified. Seeding methods will be dependent on the site conditions and slope grades. Drill seeding, hydro-seeding or broadcast seeding may be utilized in accordance with FERC’s Plan. If hydro-seeding or broadcast seeding are utilized, the seed mix rates will be doubled accordingly.

Revegetated areas will be monitored following construction in accordance with FERC’s Plan and Procedures to assure success criteria has been met.



### 7.5.5 Contaminated Soils

Areas of potential contaminated soils are identified in Resource Report 8, Section 8.4 Contaminated or Hazardous Waste Sites. It is not likely that the Project will cross areas of contamination. However, if contaminated or suspect soils are identified during trenching operations, the applicable agencies will be notified and Spire will adhere to the Unanticipated Discovery of Contaminants Plan provided in Resource Report 8, Appendix 8-E. Work in this area will stop until the type and extent of contamination is determined.

## 7.6 References

- Behymer, Brad. 2016. Email from the United States Department of Agriculture, Natural Resources Conservation Service - Greene and Jersey Counties Soil and Water Conservation Districts to Andrea Halfhill, GAI on October 13, 2016.
- Cook, Renee. 2016. Email from the United States Department of Agriculture, Natural Resources Conservation Service to Andrea Halfhill, GAI on September 28, 2016.
- Diebal, Jamie. 2017. Email from Farm Service Agency to Ali Trunzo, GAI on March 31, 2017.
- Diebal, Jamie. 2016. Email from Farm Service Agency to Andrea Halfhill, GAI on October 17, 2016.
- Gibson, Connie. 2016. Email from the United States Department of Agriculture Farm Service Agency to Andrea Halfhill, GAI on December 27, 2016.
- Federal Energy Regulatory Commission. 2013. *Upland Erosion Control, Revegetation, and Maintenance Plan*.
- Federal Energy Regulatory Commission. 2013. *Wetland and Waterbody Construction and Mitigation Procedures*.
- Mueller, Lance. 2016. Email from Scott County Soil and Water Conservation District to Andrea Halfhill, GAI on September 28, 2016.
- Natural Resources Conservation Service. 2015. Illinois Field Office Technical Guide. *Critical Area Planting*. March 2015.
- Natural Resources Conservation Service. 2012. Missouri Field Office Technical Guide. *Vegetation Establishment, Herbaceous Seeding*. July 2012.
- Natural Resources Conservation Service. 2010. Missouri Field Office Technical Guide. *Conservation Practice Standard, Critical Area Planting*. January 2010.
- Natural Resources Conservation Service. 2002. *Illinois Urban Manual, A Technical Manual Designated for Urban Ecosystem Protection and Enhancement*. Champaign, IL. March 2015.
- Niemeyer, Eric. Email from United States Department of Agriculture Farm Service Agency to Ali Trunzo, GAI on March 31, 2017.



United States Department of Agriculture, Natural Resources Conservation Service. 2015a. *Web Soil Survey (WSS) Database for Greene, Jersey and Scott Counties, Illinois*. Accessed April 2017 from <http://websoilsurvey.sc.egov.usda.gov/App/HomePage.htm>.

United States Department of Agriculture, Natural Resources Conservation Service. 2015b. *Web Soil Survey (WSS) Database for St. Charles County and St. Louis County and St. Louis City, Missouri*. Accessed April 2017 from <http://websoilsurvey.sc.egov.usda.gov/App/HomePage.htm>.

United States Department of Agriculture, Natural Resources Conservation Service. 2014. *Field Office Technical Guide*. Accessed October 2015 from <http://www.nrcs.usda.gov/wps/portal/nrcs/main/national/technical/fotg/>.

United States Department of Agriculture, Natural Resources Conservation Service. 2000. *Prime Farmland*. Accessed December 2016 from [https://www.nrcs.usda.gov/wps/portal/nrcs/detail/null/?cid=nrcs143\\_014052](https://www.nrcs.usda.gov/wps/portal/nrcs/detail/null/?cid=nrcs143_014052).

United States Department of Agriculture, Farm Service Agency. Undated. *Conservation Reserve Program*. Accessed December 2016 from <https://www.fsa.usda.gov/programs-and-services/conservation-programs/conservation-reserve-program/>.



**APPENDIX 7-A**  
**Soils Mapping**

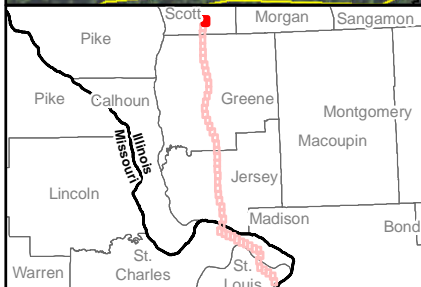
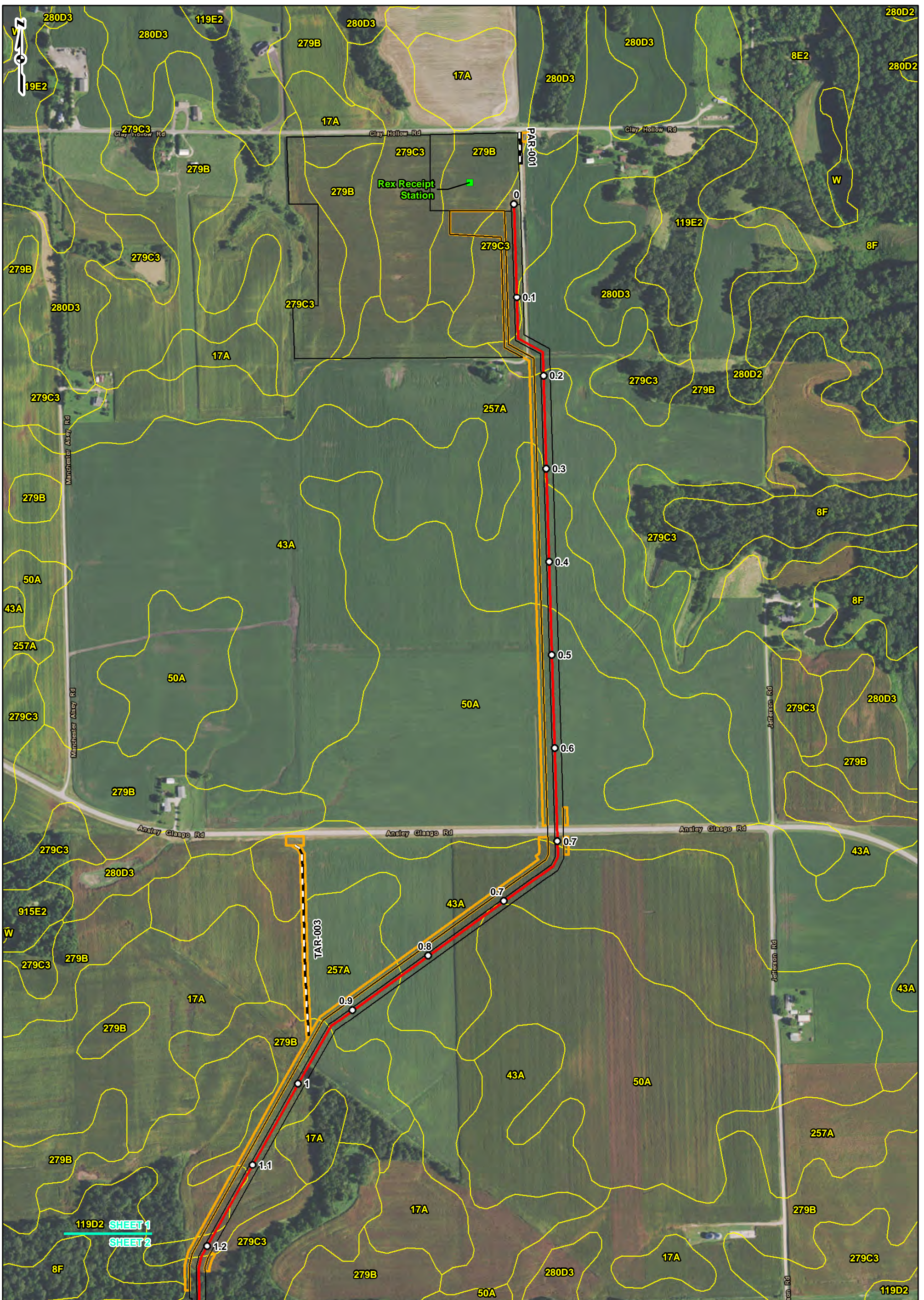

REFERENCE: ESRI WORLD IMAGERY AND TRANSPORTATION, NAIP, USDA FSA, 2014, ACCESSED 04/2017, SOIL SURVEY GEOGRAPHIC (SSURGO) DATABASE FOR ILLINOIS (2014) AND MISSOURI (2015), USDA/NRCS.

**LEGEND**

- FACILITY
- MILEPOST
- 24-INCH PIPELINE
- NORTH COUNTY EXTENSION
- - - ACCESS ROAD
- SOIL TYPE BOUNDARY
- PERMANENT LIMIT OF DISTURBANCE
- TEMPORARY LIMIT OF DISTURBANCE
- TEMPORARY AND PERMANENT LIMIT OF DISTURBANCE
- COUNTY BOUNDARY
- STATE BOUNDARY

0      250      500      1,000  
Feet

**SOILS MAP  
SHEET 1 OF 51**

**SPIRE STL  
PIPELINE  
PROJECT**

DRAWN BY: PMH      DATE: 4/6/2017  
 CHECKED: EFJ      APPROVED: LMF

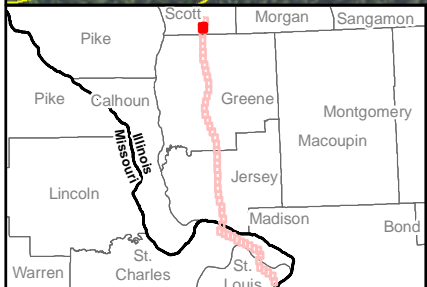
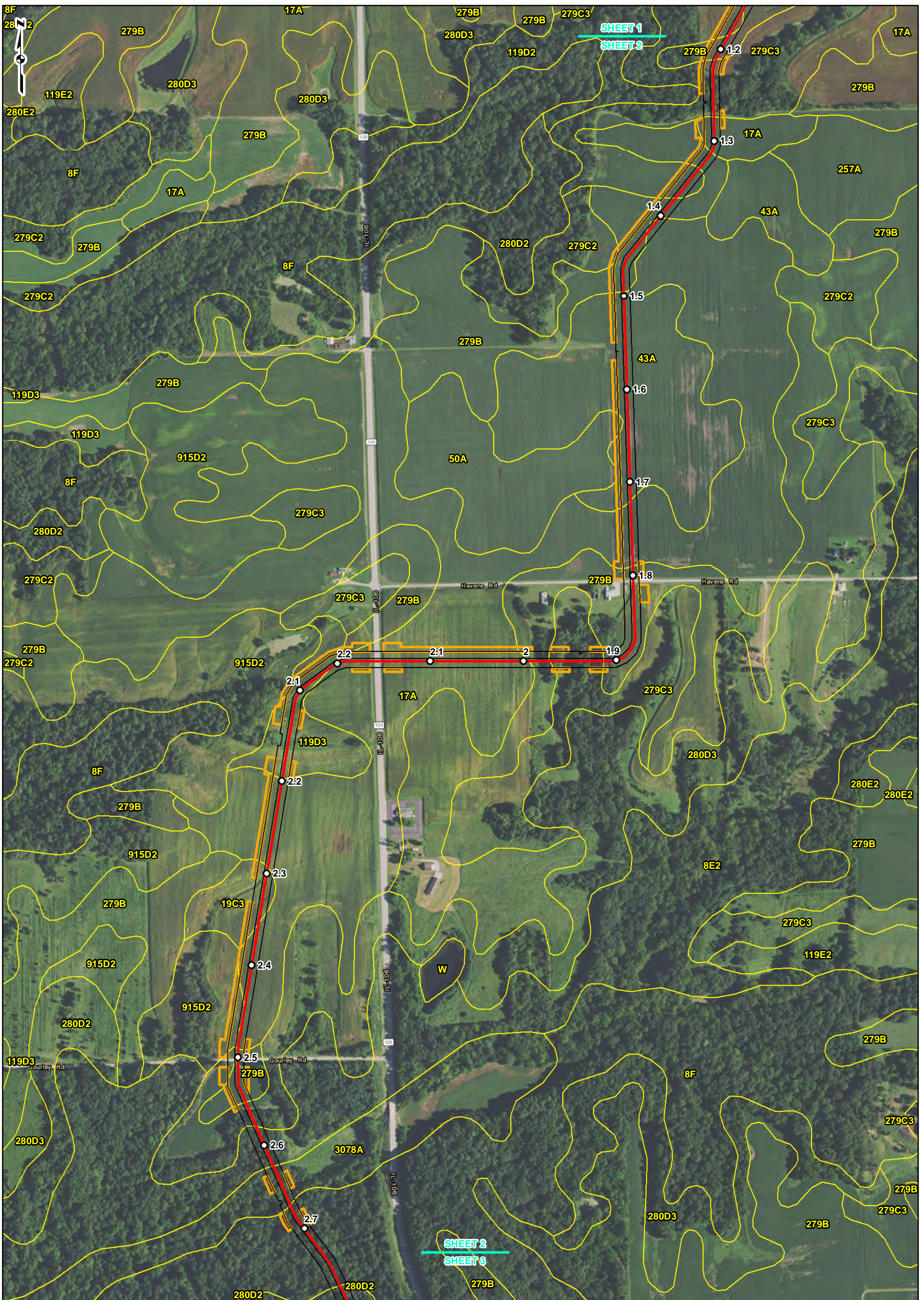

REFERENCE: ESRI WORLD IMAGERY AND TRANSPORTATION, NIP, USDA FSA, 2014, ACCESSED 04/2017, SOIL SURVEY GEOGRAPHIC (SSURGO) DATABASE FOR ILLINOIS (2014) AND MISSOURI (2015), USDA/NRCS.

**LEGEND**

- FACILITY
- MILEPOST
- 24-INCH PIPELINE
- NORTH COUNTY EXTENSION
- ACCESS ROAD
- SOIL TYPE BOUNDARY
- PERMANENT LIMIT OF DISTURBANCE
- TEMPORARY LIMIT OF DISTURBANCE
- LIMIT OF DISTURBANCE
- COUNTY BOUNDARY
- STATE BOUNDARY

0 250 500 1,000 Feet

**SOILS MAP  
SHEET 2 OF 51**

**SPIRE STL  
PIPELINE  
PROJECT**

DRAWN BY: PMH      DATE: 4/6/2017  
 CHECKED: EFJ      APPROVED: LMF



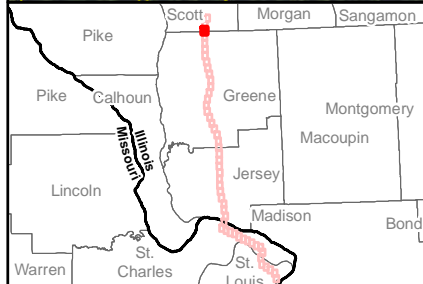
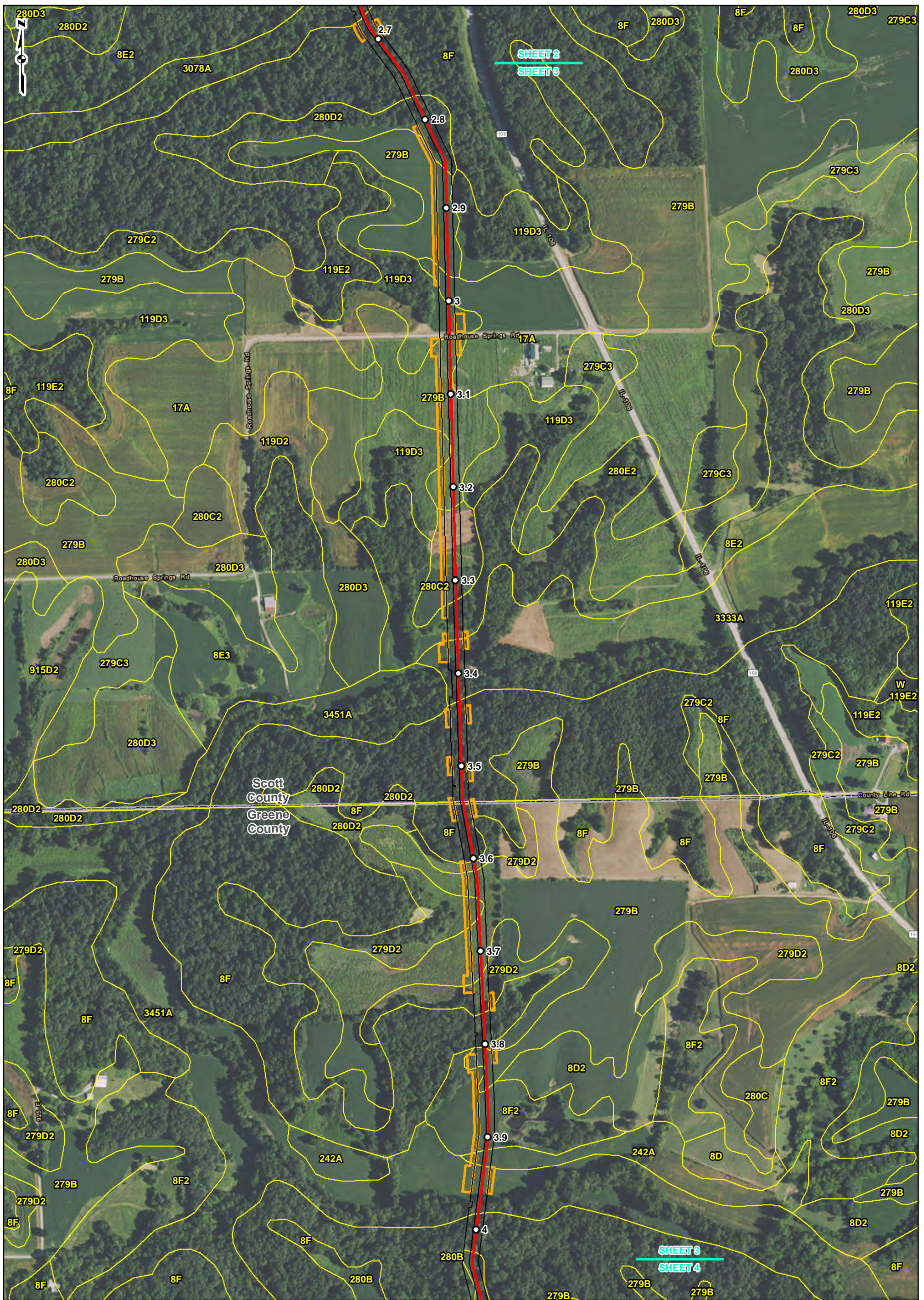

REFERENCE: ESRI WORLD IMAGERY AND TRANSPORTATION, NAIP, USDA FSA, 2014. ACCESSED 04/2017. SOIL SURVEY GEOGRAPHIC (SSURGO) DATABASE FOR ILLINOIS (2014) AND MISSOURI (2015), USDA/NRCS.

**LEGEND**

- FACILITY
- MILEPOST
- 24-INCH PIPELINE
- NORTH COUNTY EXTENSION
- ACCESS ROAD
- SOIL TYPE BOUNDARY
- PERMANENT LIMIT OF DISTURBANCE
- TEMPORARY LIMIT OF DISTURBANCE
- TEMPORARY AND PERMANENT LIMIT OF DISTURBANCE
- COUNTY BOUNDARY
- STATE BOUNDARY

0      250      500      1,000  
Feet

**SOILS MAP  
SHEET 3 OF 51**

**SPIRE STL  
PIPELINE  
PROJECT**

gal consultants      spire

DRAWN BY: PMH      DATE: 4/6/2017  
CHECKED: EFJ      APPROVED: LMF

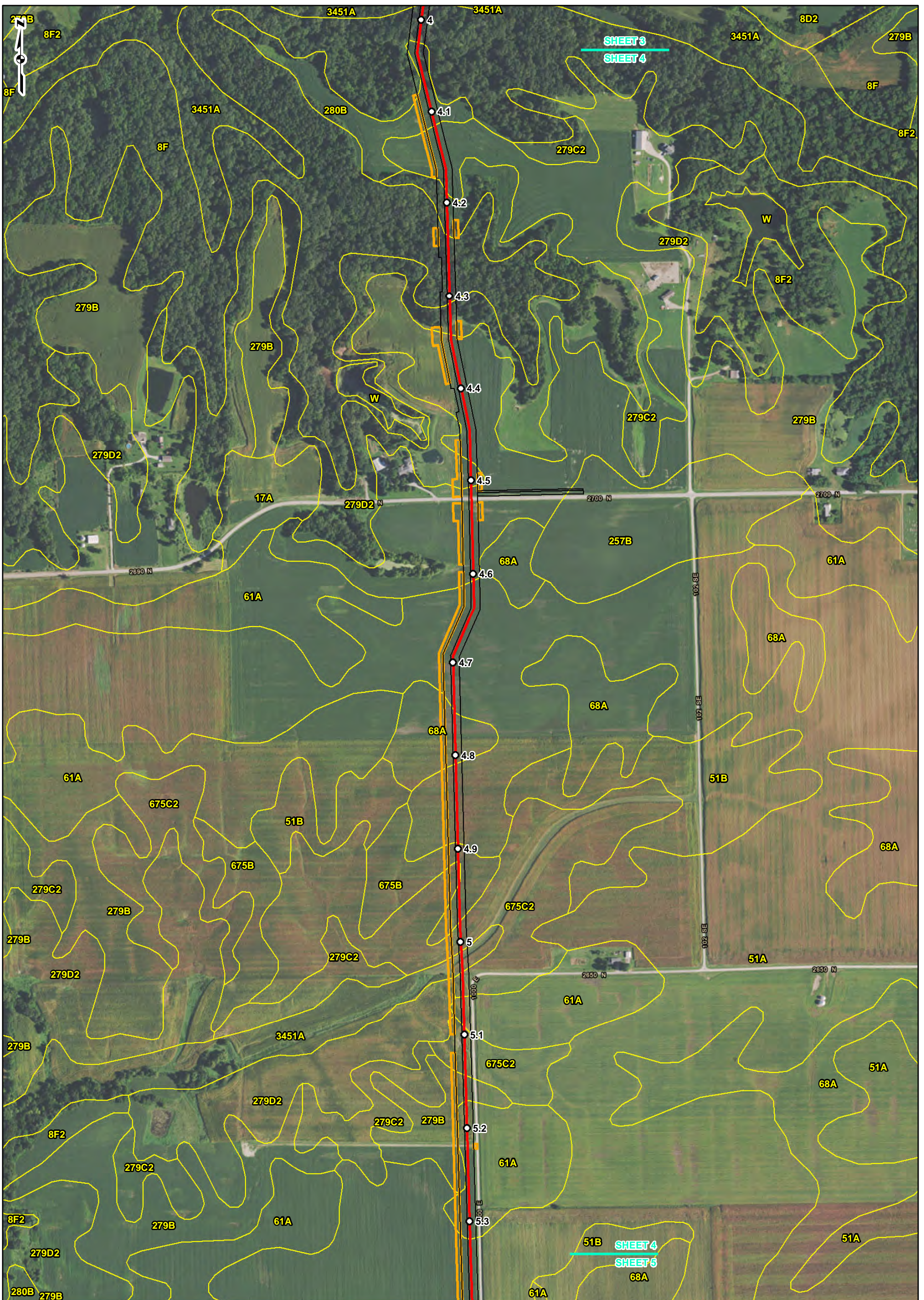

REFERENCE: ESRI WORLD IMAGERY AND TRANSPORTATION, NAIP, USDA FSA, 2014. ACCESSED 04/2017. SOIL SURVEY GEOGRAPHIC (SSURGO) DATABASE FOR ILLINOIS (2014) AND MISSOURI (2015), USDA/NRCS.

**LEGEND**

- FACILITY
- MILEPOST
- 24-INCH PIPELINE
- NORTH COUNTY EXTENSION
- ACCESS ROAD
- SOIL TYPE BOUNDARY
- PERMANENT LIMIT OF DISTURBANCE
- TEMPORARY LIMIT OF DISTURBANCE
- TEMPORARY AND PERMANENT LIMIT OF DISTURBANCE
- COUNTY BOUNDARY
- STATE BOUNDARY

0    250    500    1,000  
Feet

**SOILS MAP  
SHEET 4 OF 51**

**SPIRE STL  
PIPELINE  
PROJECT**

DRAWN BY: PMH      DATE: 4/6/2017  
 CHECKED: EFJ      APPROVED: LMF

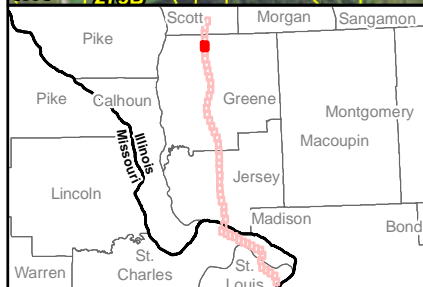
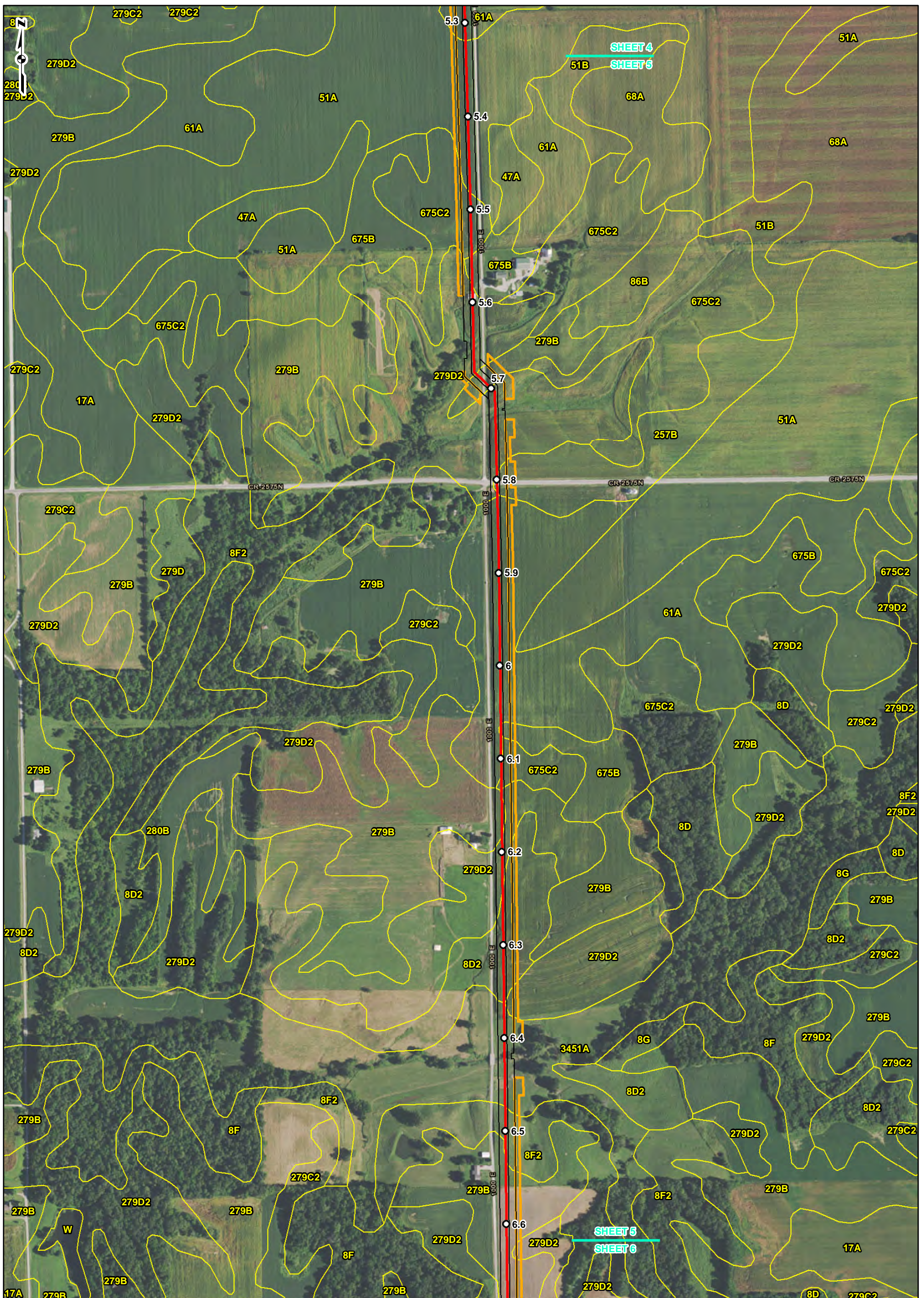

REFERENCE: ESRI WORLD IMAGERY AND TRANSPORTATION, NAIP, USDA FSA, 2014. ACCESSED 04/2017. SOIL SURVEY GEOGRAPHIC (SSURGO) DATABASE FOR ILLINOIS (2014) AND MISSOURI (2015), USDA/NRCS.

**LEGEND**

- FACILITY
- MILEPOST
- 24-INCH PIPELINE
- NORTH COUNTY EXTENSION
- ACCESS ROAD
- SOIL TYPE BOUNDARY
- PERMANENT LIMIT OF DISTURBANCE
- TEMPORARY LIMIT OF DISTURBANCE
- TEMPORARY AND PERMANENT LIMIT OF DISTURBANCE
- COUNTY BOUNDARY
- STATE BOUNDARY

0      250      500      1,000  
Feet

**SOILS MAP  
SHEET 5 OF 51**

**SPIRE STL  
PIPELINE  
PROJECT**

DRAWN BY: PMH      DATE: 4/6/2017  
 CHECKED: EFJ      APPROVED: LMF

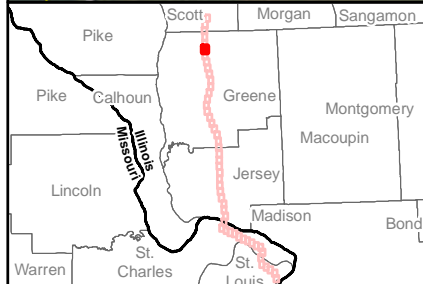
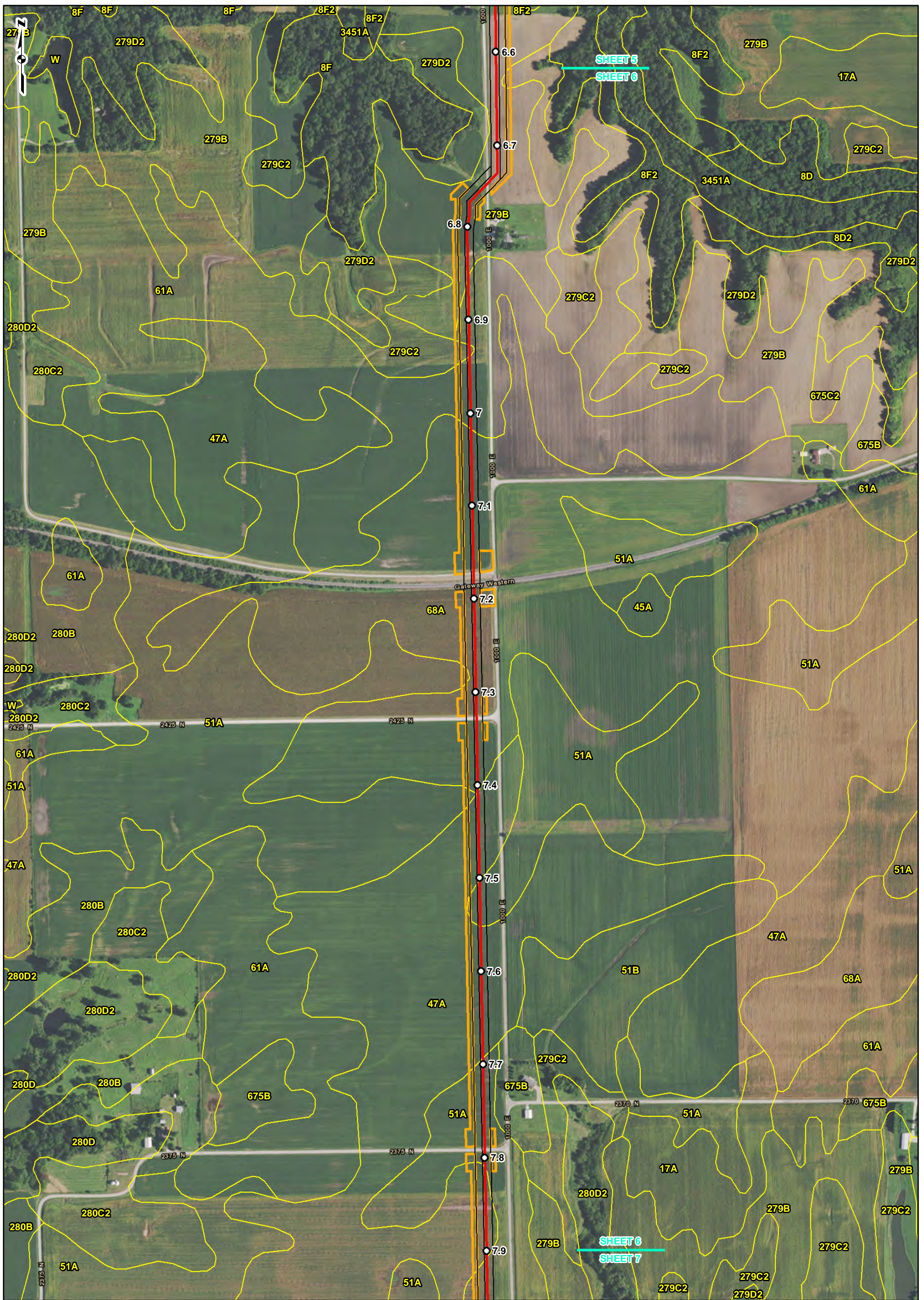

REFERENCE: ESRI WORLD IMAGERY AND TRANSPORTATION, NAIP, USDA FSA, 2014, ACCESSED 04/2017, SOIL SURVEY GEOGRAPHIC (SSURGO) DATABASE FOR ILLINOIS (2014) AND MISSOURI (2015), USDA/NRCS.

**LEGEND**

- FACILITY
- MILEPOST
- 24-INCH PIPELINE
- NORTH COUNTY EXTENSION
- ACCESS ROAD
- SOIL TYPE BOUNDARY
- PERMANENT LIMIT OF DISTURBANCE
- TEMPORARY LIMIT OF DISTURBANCE
- TEMPORARY AND PERMANENT LIMIT OF DISTURBANCE
- COUNTY BOUNDARY
- STATE BOUNDARY

0    250    500    1,000  
Feet

**SOILS MAP  
SHEET 6 OF 51**

**SPIRE STL  
PIPELINE  
PROJECT**

DRAWN BY: PMH      DATE: 4/6/2017  
 CHECKED: EFJ      APPROVED: LMF



REFERENCE: ESRI WORLD IMAGERY AND TRANSPORTATION, NAIP, USDA FSA, 2014. ACCESSED 04/2017. SOIL SURVEY GEOGRAPHIC (SSURGO) DATABASE FOR ILLINOIS (2014) AND MISSOURI (2015), USDA/NRCS.

**LEGEND**

- FACILITY
- MILEPOST
- 24-INCH PIPELINE
- NORTH COUNTY EXTENSION
- ACCESS ROAD
- SOIL TYPE BOUNDARY
- PERMANENT LIMIT OF DISTURBANCE
- TEMPORARY LIMIT OF DISTURBANCE
- TEMPORARY AND PERMANENT LIMIT OF DISTURBANCE
- COUNTY BOUNDARY
- STATE BOUNDARY

0 250 500 1,000 Feet

**SOILS MAP  
SHEET 7 OF 51**

**SPIRE STL  
PIPELINE  
PROJECT**

DRAWN BY: PMH      DATE: 4/6/2017  
 CHECKED: EFJ      APPROVED: LMF

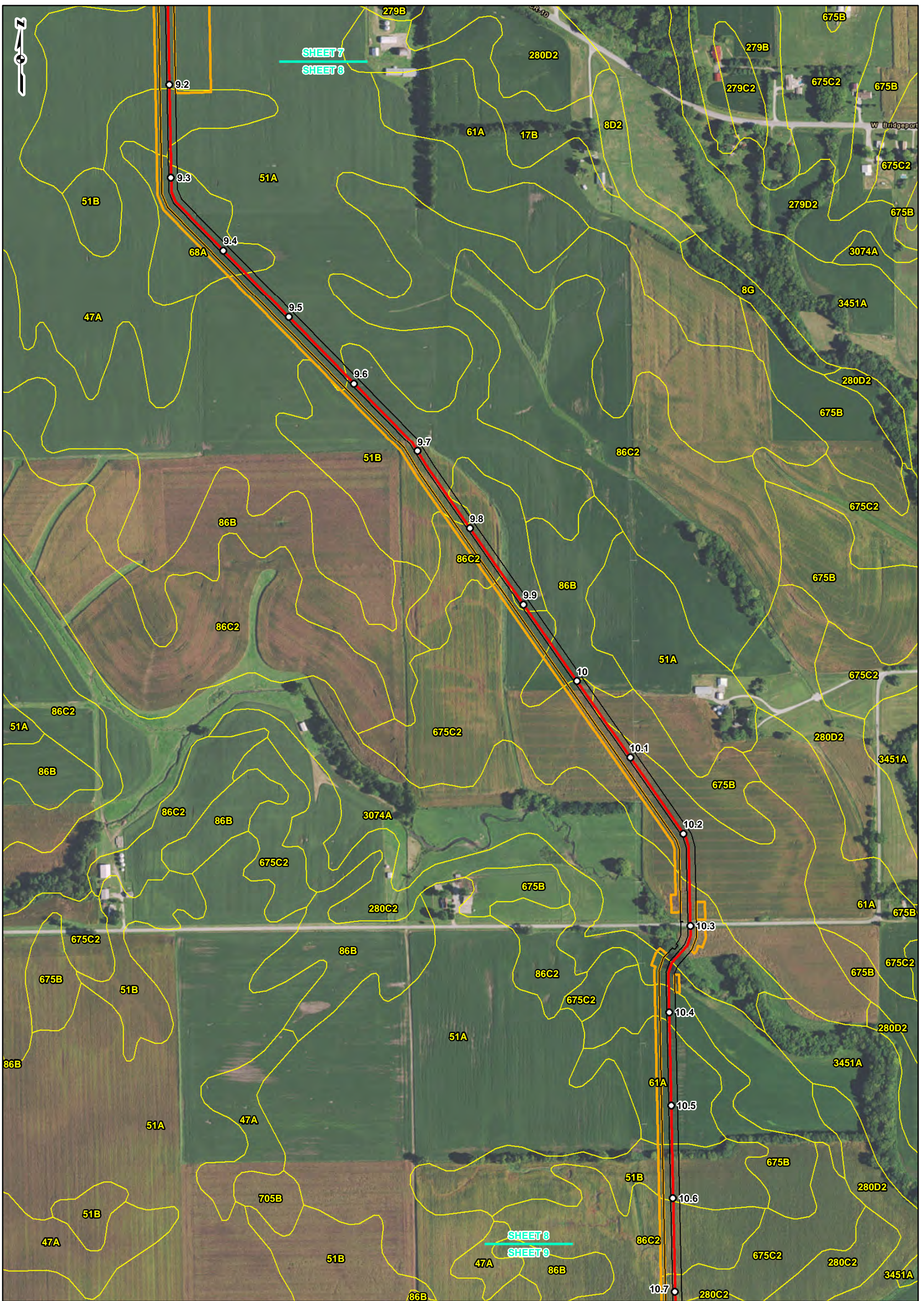

REFERENCE: ESRI WORLD IMAGERY AND TRANSPORTATION, NAIP, USDA FSA, 2014. ACCESSED 04/2017. SOIL SURVEY GEOGRAPHIC (SSURGO) DATABASE FOR ILLINOIS (2014) AND MISSOURI (2015), USDA/NRCS.

**LEGEND**

- FACILITY
- MILEPOST
- 24-INCH PIPELINE
- NORTH COUNTY EXTENSION
- ACCESS ROAD
- SOIL TYPE BOUNDARY
- PERMANENT LIMIT OF DISTURBANCE
- TEMPORARY LIMIT OF DISTURBANCE
- LIMIT OF DISTURBANCE
- COUNTY BOUNDARY
- STATE BOUNDARY

0      250      500      1,000  
Feet

**SOILS MAP  
SHEET 8 OF 51**

**SPIRE STL  
PIPELINE  
PROJECT**

DRAWN BY: PMH      DATE: 4/6/2017  
 CHECKED: EFJ      APPROVED: LMF

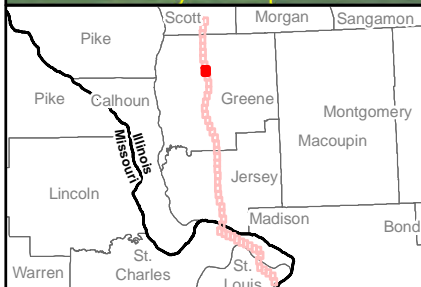

REFERENCE: ESRI WORLD IMAGERY AND TRANSPORTATION, NAIIP, USDA FSA, 2014. ACCESSED 04/2017. SOIL SURVEY GEOGRAPHIC (SSURGO) DATABASE FOR ILLINOIS (2014) AND MISSOURI (2015), USDA/NRCS.

**LEGEND**

FACILITY	PERMANENT LIMIT OF DISTURBANCE
MILEPOST	TEMPORARY LIMIT OF DISTURBANCE
24-INCH PIPELINE	TEMPORARY AND PERMANENT LIMIT OF DISTURBANCE
NORTH COUNTY EXTENSION	COUNTY BOUNDARY
ACCESS ROAD	STATE BOUNDARY
SOIL TYPE BOUNDARY	

0 250 500 1,000 Feet

**SOILS MAP  
SHEET 9 OF 51**

**SPIRE STL  
PIPELINE  
PROJECT**

DRAWN BY: PMH	DATE: 4/6/2017
CHECKED: EFJ	APPROVED: LMF

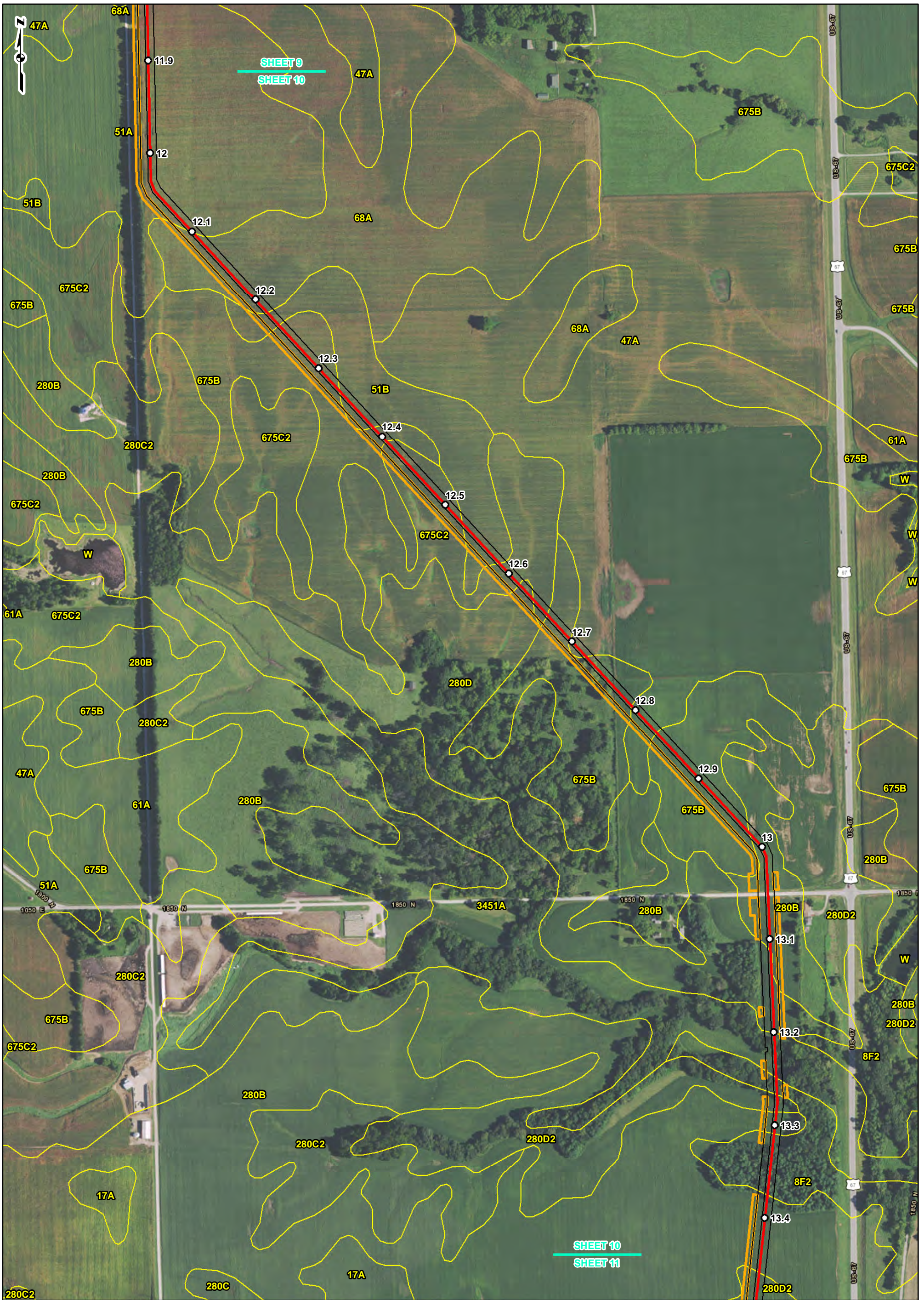

REFERENCE: ESRI WORLD IMAGERY AND TRANSPORTATION, NAI, USDA FSA, 2014. ACCESSED 04/2017. SOIL SURVEY GEOGRAPHIC (SSURGO) DATABASE FOR ILLINOIS (2014) AND MISSOURI (2015), USDA/NRCS.

**LEGEND**

- FACILITY
- MILEPOST
- 24-INCH PIPELINE
- NORTH COUNTY EXTENSION
- ACCESS ROAD
- SOIL TYPE BOUNDARY
- PERMANENT LIMIT OF DISTURBANCE
- TEMPORARY LIMIT OF DISTURBANCE
- LIMIT OF DISTURBANCE
- COUNTY BOUNDARY
- STATE BOUNDARY

0      250      500      1,000  
Feet

**SOILS MAP  
SHEET 10 OF 51**

**SPIRE STL  
PIPELINE  
PROJECT**

DRAWN BY: PMH      DATE: 4/6/2017  
 CHECKED: EFJ      APPROVED: LMF



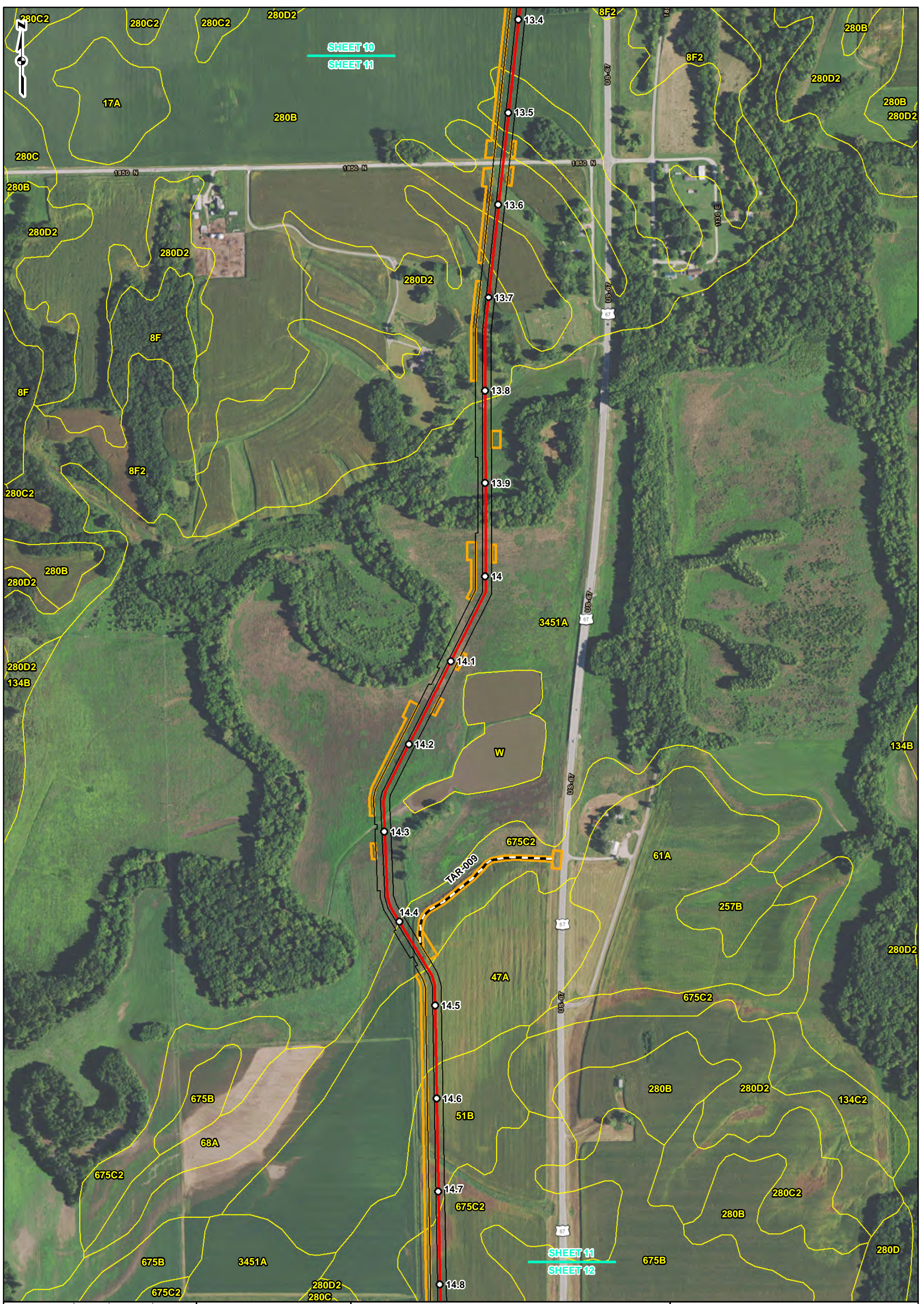

REFERENCE: ESRI WORLD IMAGERY AND TRANSPORTATION, NAIIP, USDA FSA, 2014, ACCESSED 04/2017, SOIL SURVEY GEOGRAPHIC (SSURGO) DATABASE FOR ILLINOIS (2014) AND MISSOURI (2015), USDA/NRCS.

**LEGEND**

<span style="color: green;">■</span> FACILITY	<span style="border: 1px solid black; display: inline-block; width: 10px; height: 10px;"></span> PERMANENT LIMIT OF DISTURBANCE
<span style="color: red;">○</span> MILEPOST	<span style="border: 2px solid orange; display: inline-block; width: 10px; height: 10px;"></span> TEMPORARY LIMIT OF DISTURBANCE
<span style="color: red;">—</span> 24-INCH PIPELINE	<span style="border: 2px dashed orange; display: inline-block; width: 10px; height: 10px;"></span> TEMPORARY AND PERMANENT LIMIT OF DISTURBANCE
<span style="color: orange;">—</span> NORTH COUNTY EXTENSION	<span style="border: 1px solid grey; display: inline-block; width: 10px; height: 10px;"></span> COUNTY BOUNDARY
<span style="color: black;">—</span> ACCESS ROAD	<span style="border: 2px solid grey; display: inline-block; width: 10px; height: 10px;"></span> STATE BOUNDARY
<span style="color: yellow;">—</span> SOIL TYPE BOUNDARY	

0     250     500     1,000 Feet

**SOILS MAP  
SHEET 11 OF 51**

**SPIRE STL  
PIPELINE  
PROJECT**

  
gal consultants

DRAWN BY: PMH  
CHECKED: EFJ

 spire

DATE: 4/6/2017  
APPROVED: LMF

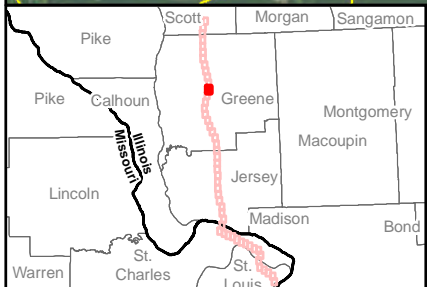
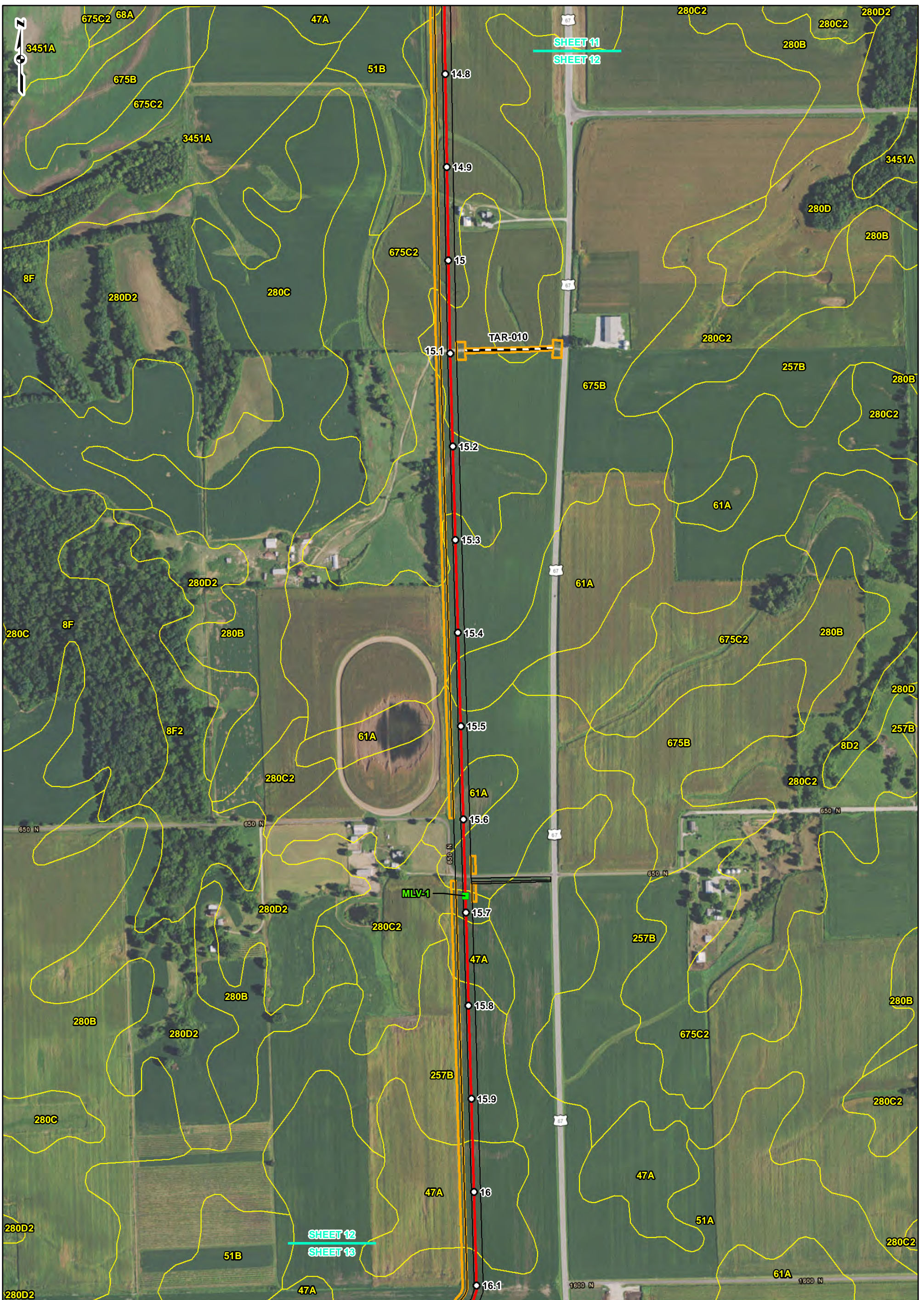

REFERENCE: ESRI WORLD IMAGERY AND TRANSPORTATION, NAIP, USDA FSA, 2014, ACCESSED 04/2017, SOIL SURVEY GEOGRAPHIC (SSURGO) DATABASE FOR ILLINOIS (2014) AND MISSOURI (2015), USDA/NRCS.

**LEGEND**

- FACILITY
- MILEPOST
- 24-INCH PIPELINE
- NORTH COUNTY EXTENSION
- ACCESS ROAD
- SOIL TYPE BOUNDARY
- PERMANENT LIMIT OF DISTURBANCE
- TEMPORARY LIMIT OF DISTURBANCE
- TEMPORARY AND PERMANENT LIMIT OF DISTURBANCE
- COUNTY BOUNDARY
- STATE BOUNDARY

0      250      500      1,000  
Feet

**SOILS MAP**  
**SHEET 12 OF 51**

**SPIRE STL PIPELINE PROJECT**

DRAWN BY: PMH      DATE: 4/6/2017  
CHECKED: EFJ      APPROVED: LMF

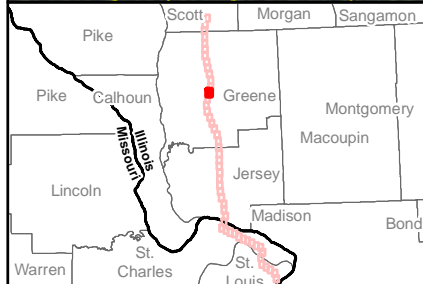
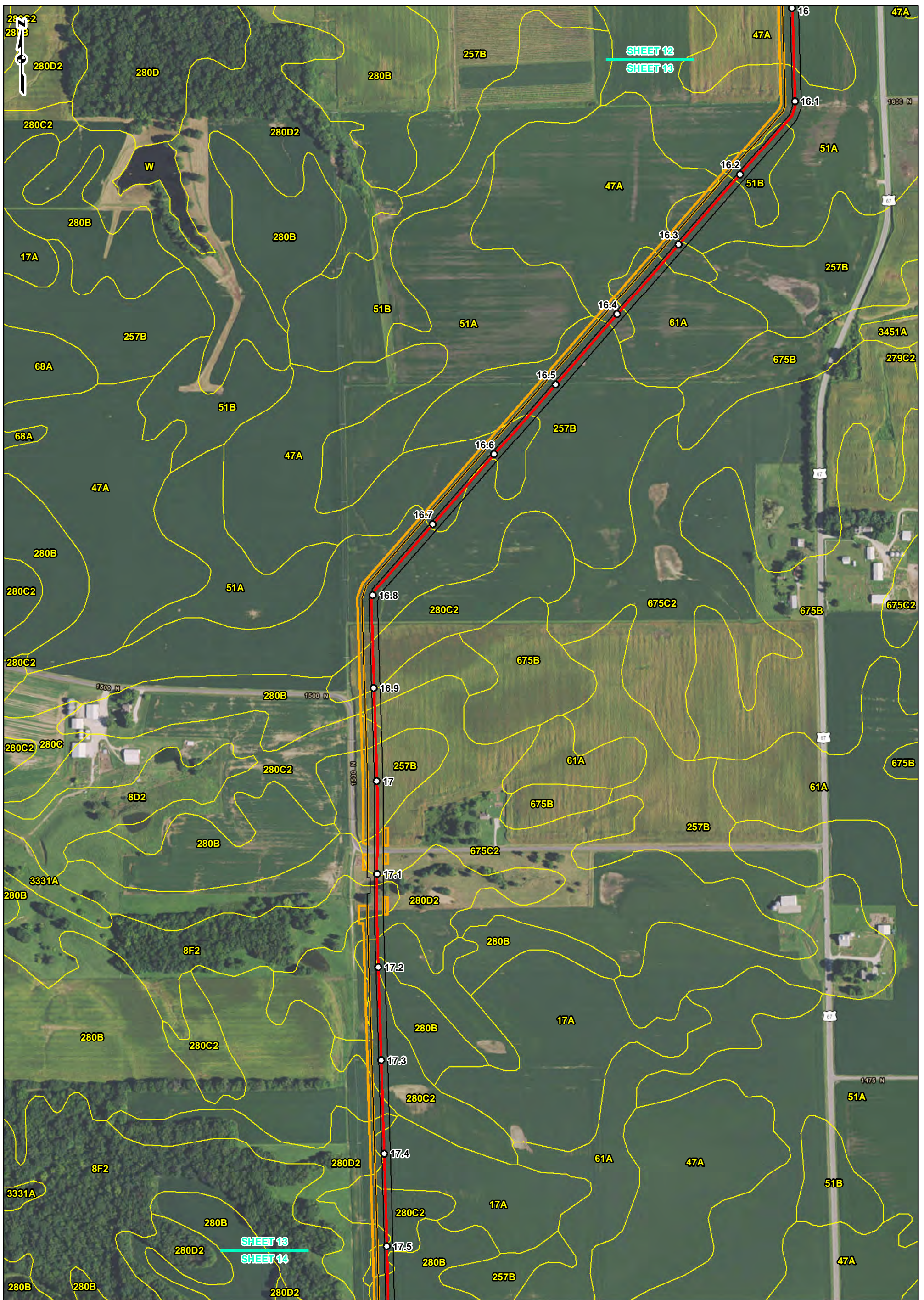

REFERENCE: ESRI WORLD IMAGERY AND TRANSPORTATION, NAIP, USDA FSA, 2014, ACCESSED 04/2017, SOIL SURVEY GEOGRAPHIC (SSURGO) DATABASE FOR ILLINOIS (2014) AND MISSOURI (2015), USDA/NRCS.

**LEGEND**

- FACILITY
- MILEPOST
- 24-INCH PIPELINE
- NORTH COUNTY EXTENSION
- ACCESS ROAD
- SOIL TYPE BOUNDARY
- PERMANENT LIMIT OF DISTURBANCE
- TEMPORARY LIMIT OF DISTURBANCE
- TEMPORARY AND PERMANENT LIMIT OF DISTURBANCE
- COUNTY BOUNDARY
- STATE BOUNDARY

0      250      500      1,000  
Feet

**SOILS MAP  
SHEET 13 OF 51**

**SPiRE STL  
PIPELINE  
PROJECT**

DRAWN BY: PMH      DATE: 4/6/2017  
 CHECKED: EFJ      APPROVED: LMF

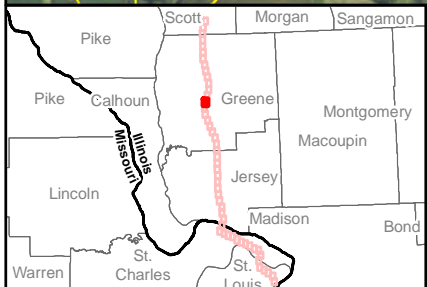
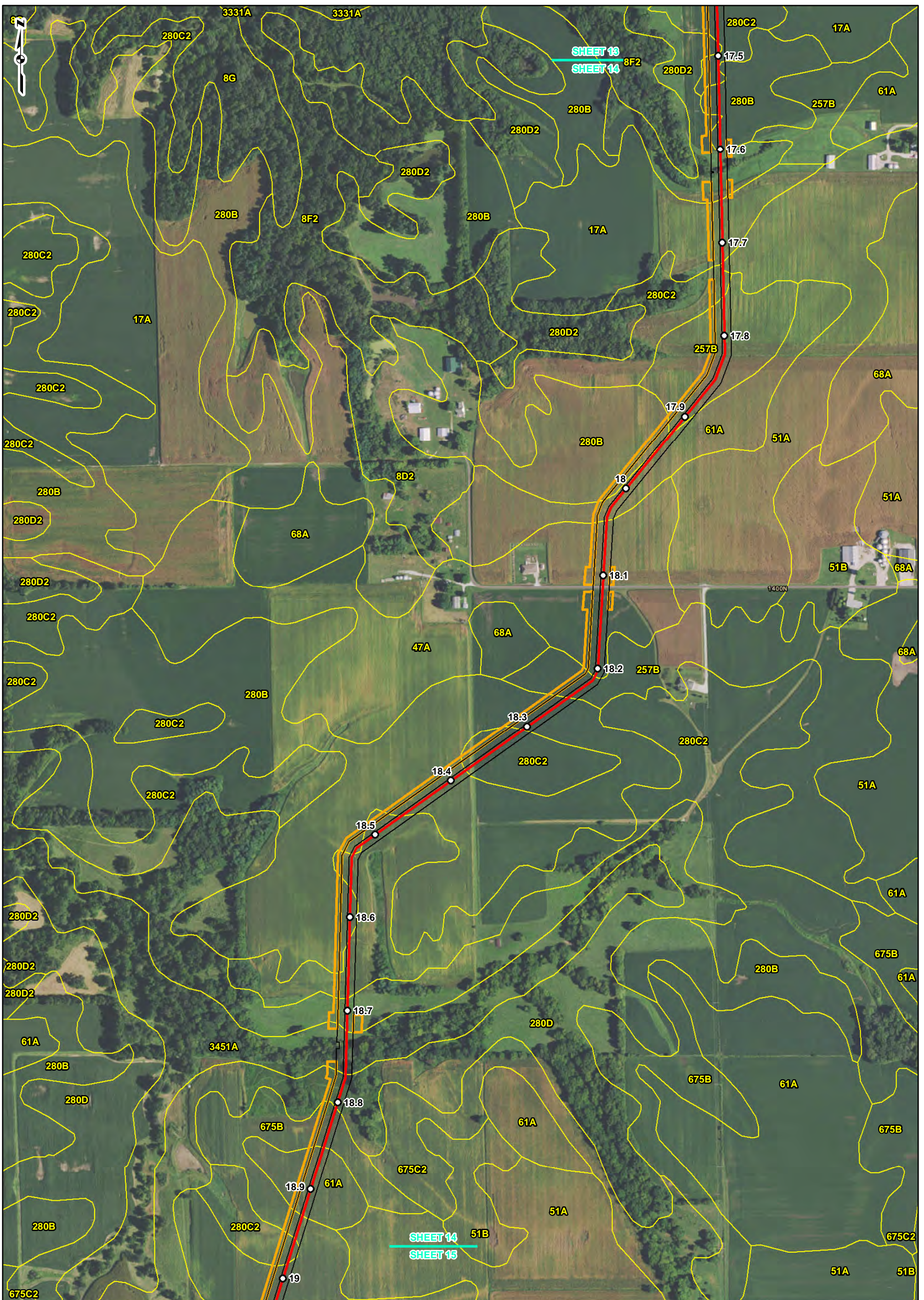

REFERENCE: ESRI WORLD IMAGERY AND TRANSPORTATION, NAIP, USDA FSA, 2014, ACCESSED 04/2017, SOIL SURVEY GEOGRAPHIC (SSURGO) DATABASE FOR ILLINOIS (2014) AND MISSOURI (2015), USDA/NRCS.

**LEGEND**

- FACILITY
- MILEPOST
- 24-INCH PIPELINE
- NORTH COUNTY EXTENSION
- ACCESS ROAD
- SOIL TYPE BOUNDARY
- PERMANENT LIMIT OF DISTURBANCE
- TEMPORARY LIMIT OF DISTURBANCE
- TEMPORARY AND PERMANENT LIMIT OF DISTURBANCE
- COUNTY BOUNDARY
- STATE BOUNDARY

0      250      500      1,000  
Feet

**SOILS MAP**  
**SHEET 14 OF 51**

**SPIRE STL PIPELINE PROJECT**

DRAWN BY: PMH      DATE: 4/6/2017  
CHECKED: EFJ      APPROVED: LMF

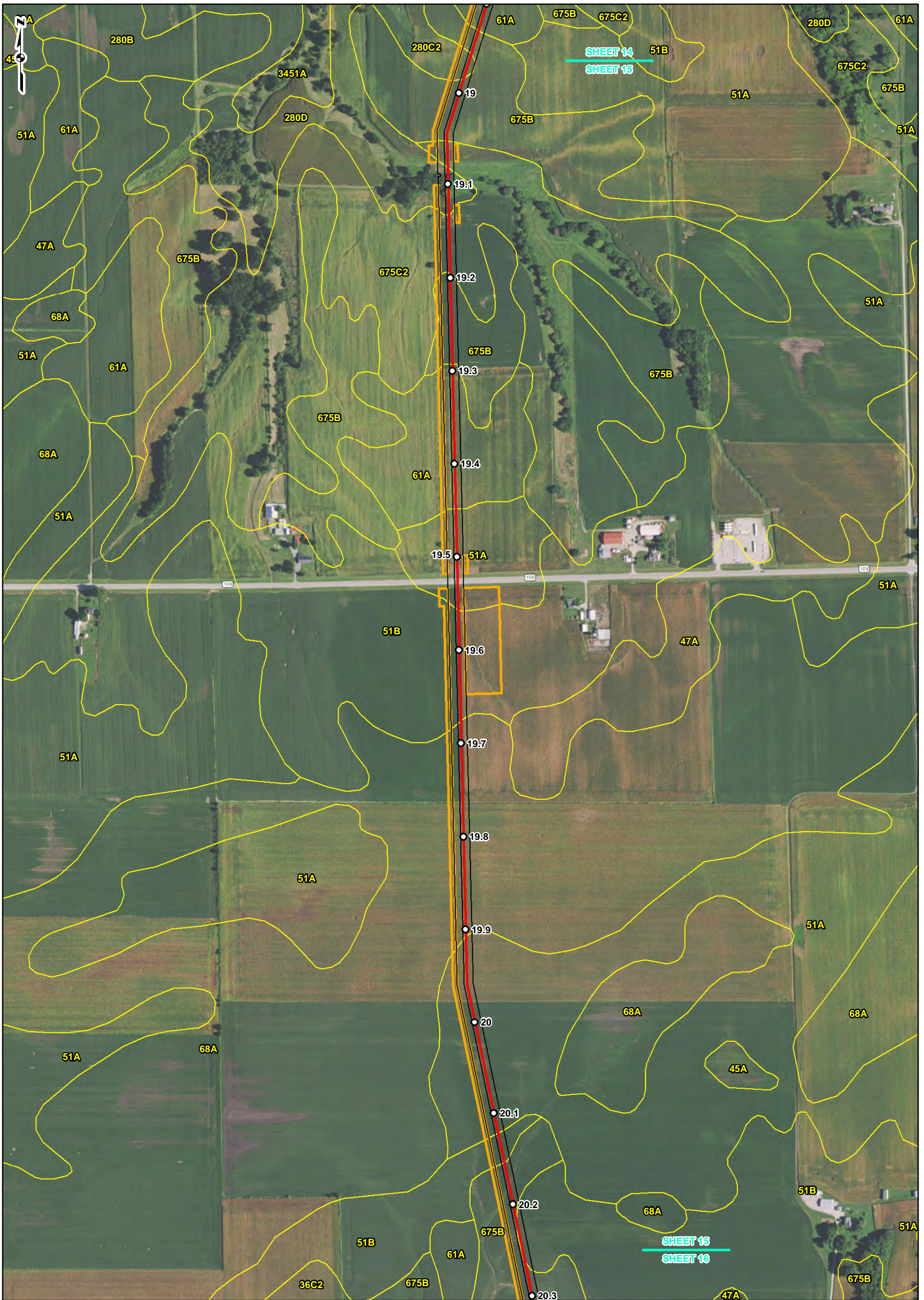

REFERENCE: ESRI WORLD IMAGERY AND TRANSPORTATION, NAIP, USDA FSA, 2014, ACCESSED 04/2017, SOIL SURVEY GEOGRAPHIC (SSURGO) DATABASE FOR ILLINOIS (2014) AND MISSOURI (2015), USDA/NRCS.

**LEGEND**

- FACILITY
- MILEPOST
- 24-INCH PIPELINE
- NORTH COUNTY EXTENSION
- ACCESS ROAD
- SOIL TYPE BOUNDARY
- PERMANENT LIMIT OF DISTURBANCE
- TEMPORARY LIMIT OF DISTURBANCE
- TEMPORARY AND PERMANENT LIMIT OF DISTURBANCE
- COUNTY BOUNDARY
- STATE BOUNDARY

0      250      500      1,000  
Feet

**SOILS MAP  
SHEET 15 OF 51**

**SPIRE STL  
PIPELINE  
PROJECT**

gal consultants **spire**

DRAWN BY: PMH      DATE: 4/6/2017  
CHECKED: EFJ      APPROVED: LMF

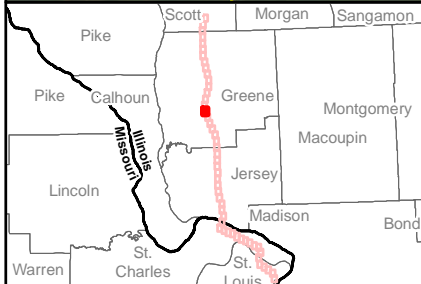
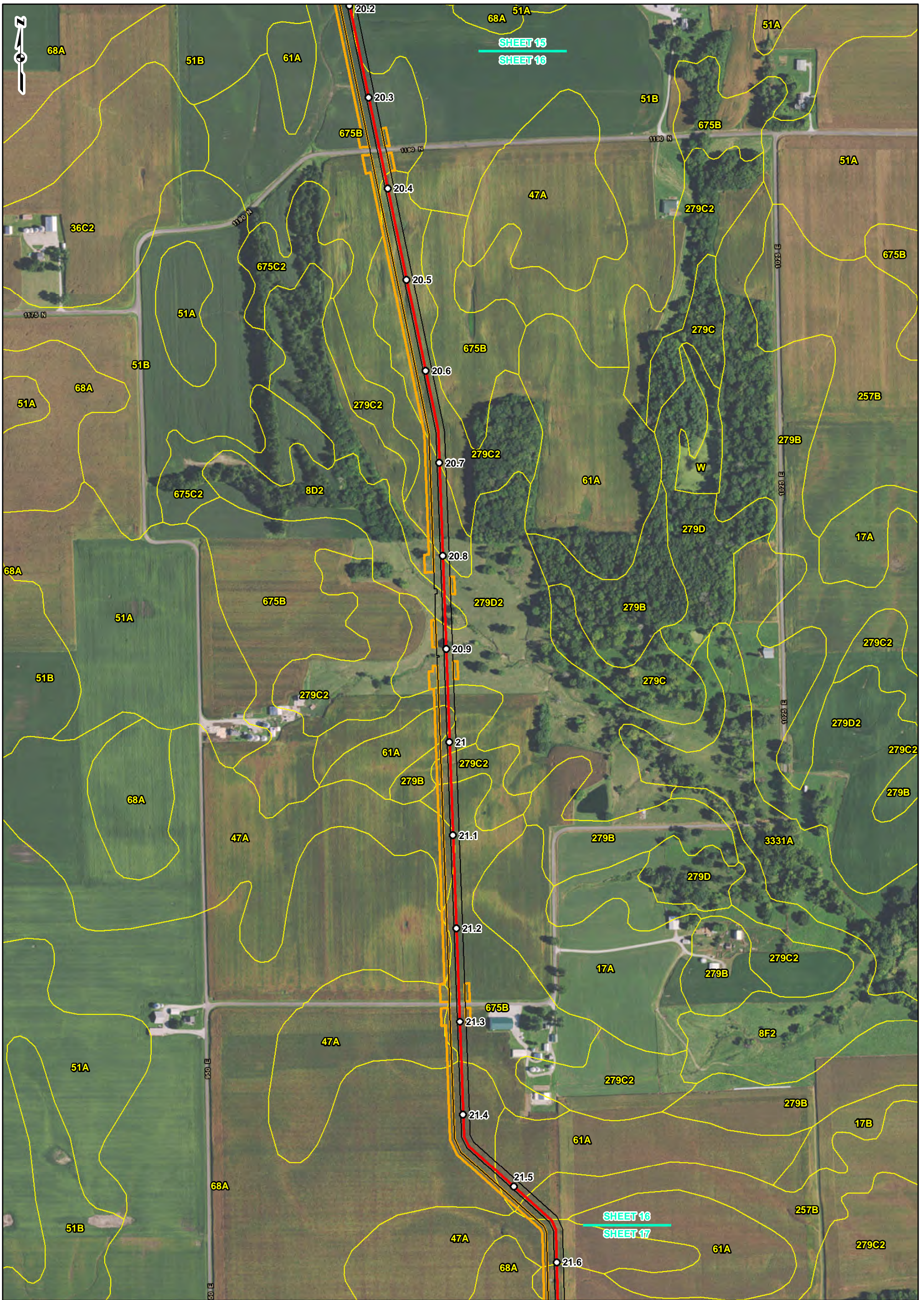

REFERENCE: ESRI WORLD IMAGERY AND TRANSPORTATION, NAIP, USDA FSA, 2014, ACCESSED 04/2017, SOIL SURVEY GEOGRAPHIC (SSURGO) DATABASE FOR ILLINOIS (2014) AND MISSOURI (2015), USDA/NRCS.

**LEGEND**

- FACILITY
- MILEPOST
- 24-INCH PIPELINE
- NORTH COUNTY EXTENSION
- ACCESS ROAD
- SOIL TYPE BOUNDARY
- PERMANENT LIMIT OF DISTURBANCE
- TEMPORARY LIMIT OF DISTURBANCE
- TEMPORARY AND PERMANENT LIMIT OF DISTURBANCE
- COUNTY BOUNDARY
- STATE BOUNDARY

0      250      500      1,000  
Feet

**SOILS MAP  
SHEET 16 OF 51**

**SPIRE STL  
PIPELINE  
PROJECT**

DRAWN BY: PMH      DATE: 4/6/2017  
CHECKED: EFJ      APPROVED: LMF

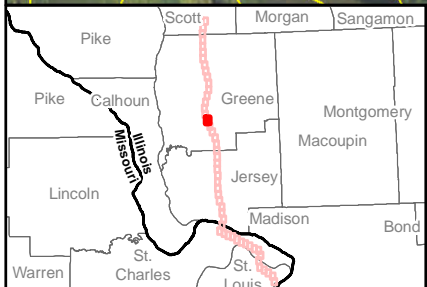
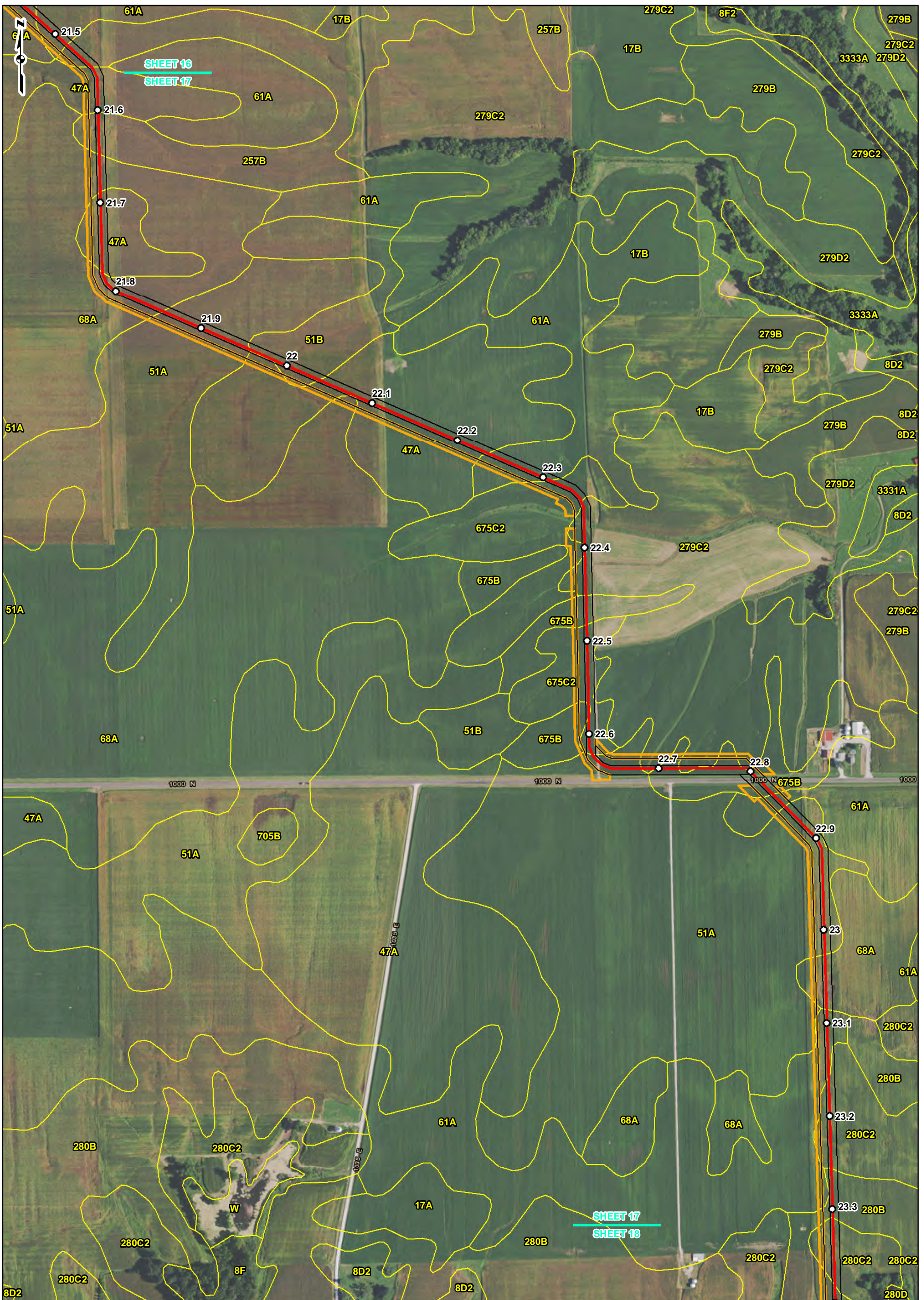

REFERENCE: ESRI WORLD IMAGERY AND TRANSPORTATION, NAIP, USDA FSA, 2014, ACCESSED 04/2017, SOIL SURVEY GEOGRAPHIC (SSURGO) DATABASE FOR ILLINOIS (2014) AND MISSOURI (2015), USDA/NRCS.

**LEGEND**

- FACILITY
- MILEPOST
- 24-INCH PIPELINE
- NORTH COUNTY EXTENSION
- ACCESS ROAD
- SOIL TYPE BOUNDARY
- PERMANENT LIMIT OF DISTURBANCE
- TEMPORARY LIMIT OF DISTURBANCE
- TEMPORARY AND PERMANENT LIMIT OF DISTURBANCE
- COUNTY BOUNDARY
- STATE BOUNDARY

0      250      500      1,000  
Feet

**SOILS MAP  
SHEET 17 OF 51**

**SPIRE STL  
PIPELINE  
PROJECT**

DRAWN BY: PMH      DATE: 4/6/2017  
 CHECKED: EFJ      APPROVED: LMF

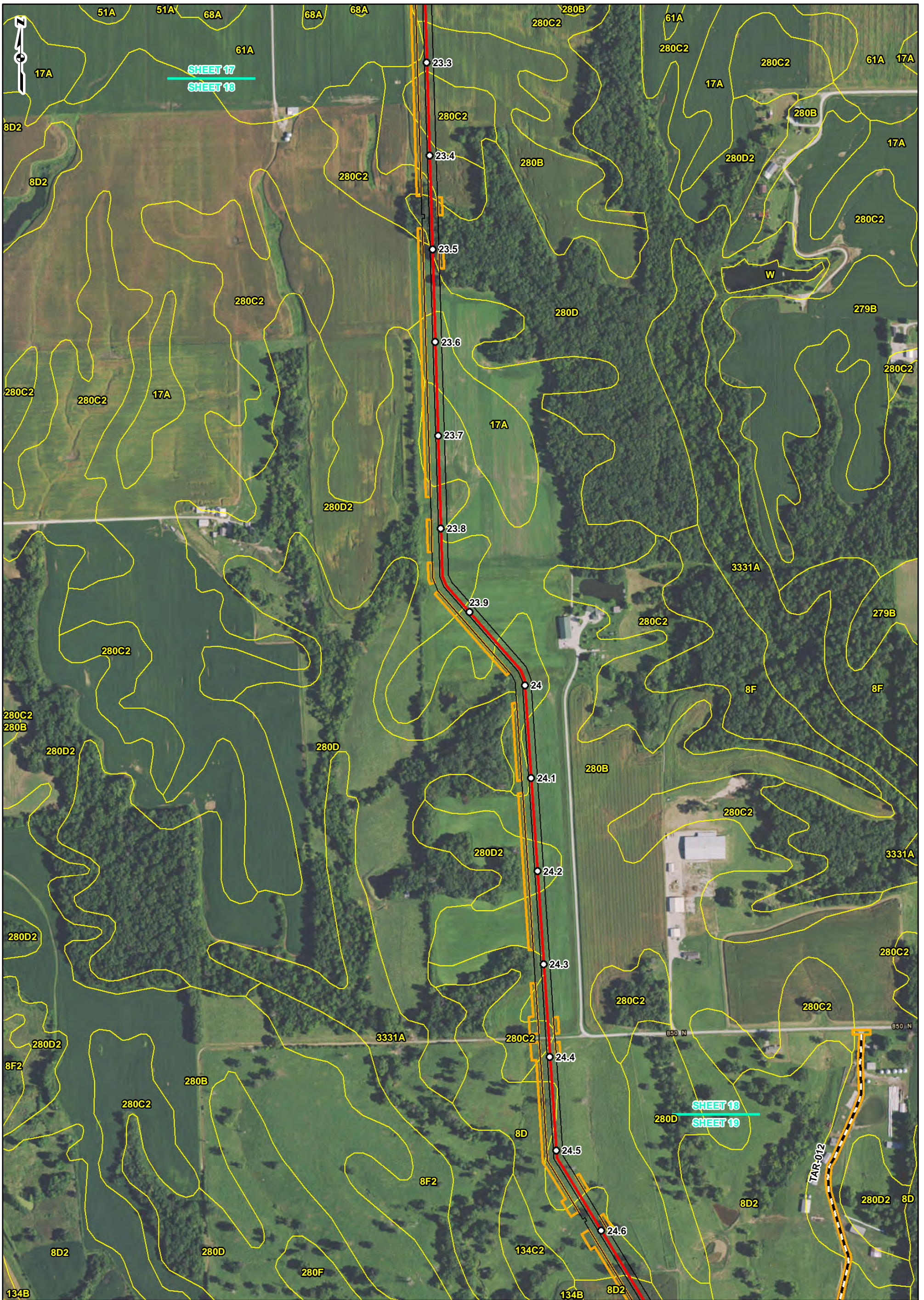

REFERENCE: ESRI WORLD IMAGERY AND TRANSPORTATION, NIP, USDA FSA, 2014. ACCESSED 04/2017. SOIL SURVEY GEOGRAPHIC (SSURGO) DATABASE FOR ILLINOIS (2014) AND MISSOURI (2015), USDA/NRCS.

**LEGEND**

- FACILITY
- MILEPOST
- 24-INCH PIPELINE
- NORTH COUNTY EXTENSION
- ACCESS ROAD
- SOIL TYPE BOUNDARY
- PERMANENT LIMIT OF DISTURBANCE
- TEMPORARY LIMIT OF DISTURBANCE
- TEMPORARY AND PERMANENT LIMIT OF DISTURBANCE
- COUNTY BOUNDARY
- STATE BOUNDARY

0      250      500      1,000  
Feet

**SOILS MAP**  
**SHEET 18 OF 51**

**SPiRE STL PIPELINE PROJECT**

DRAWN BY: PMH      DATE: 4/6/2017  
 CHECKED: EFJ      APPROVED: LMF



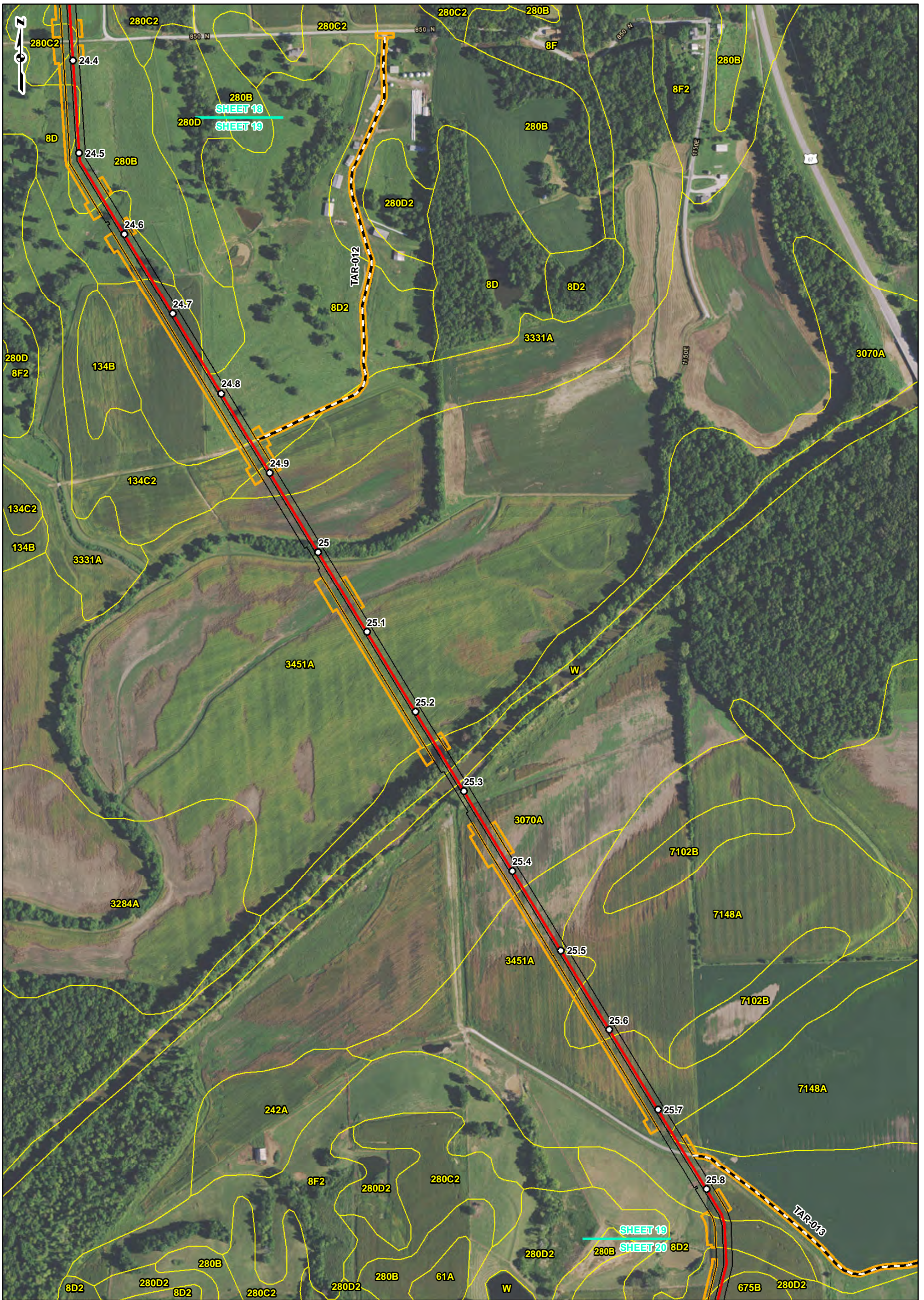

REFERENCE: ESRI WORLD IMAGERY AND TRANSPORTATION, NAIP, USDA FSA, 2014. ACCESSED 04/2017. SOIL SURVEY GEOGRAPHIC (SSURGO) DATABASE FOR ILLINOIS (2014) AND MISSOURI (2015), USDA/NRCS.

**LEGEND**

- FACILITY
- MILEPOST
- 24-INCH PIPELINE
- NORTH COUNTY EXTENSION
- - - ACCESS ROAD
- SOIL TYPE BOUNDARY
- PERMANENT LIMIT OF DISTURBANCE
- TEMPORARY LIMIT OF DISTURBANCE
- TEMPORARY AND PERMANENT LIMIT OF DISTURBANCE
- COUNTY BOUNDARY
- STATE BOUNDARY

0    250    500    1,000  
Feet

**SOILS MAP  
SHEET 19 OF 51**

**SPIRE STL  
PIPELINE  
PROJECT**

DRAWN BY: PMH      DATE: 4/6/2017  
 CHECKED: EFJ      APPROVED: LMF

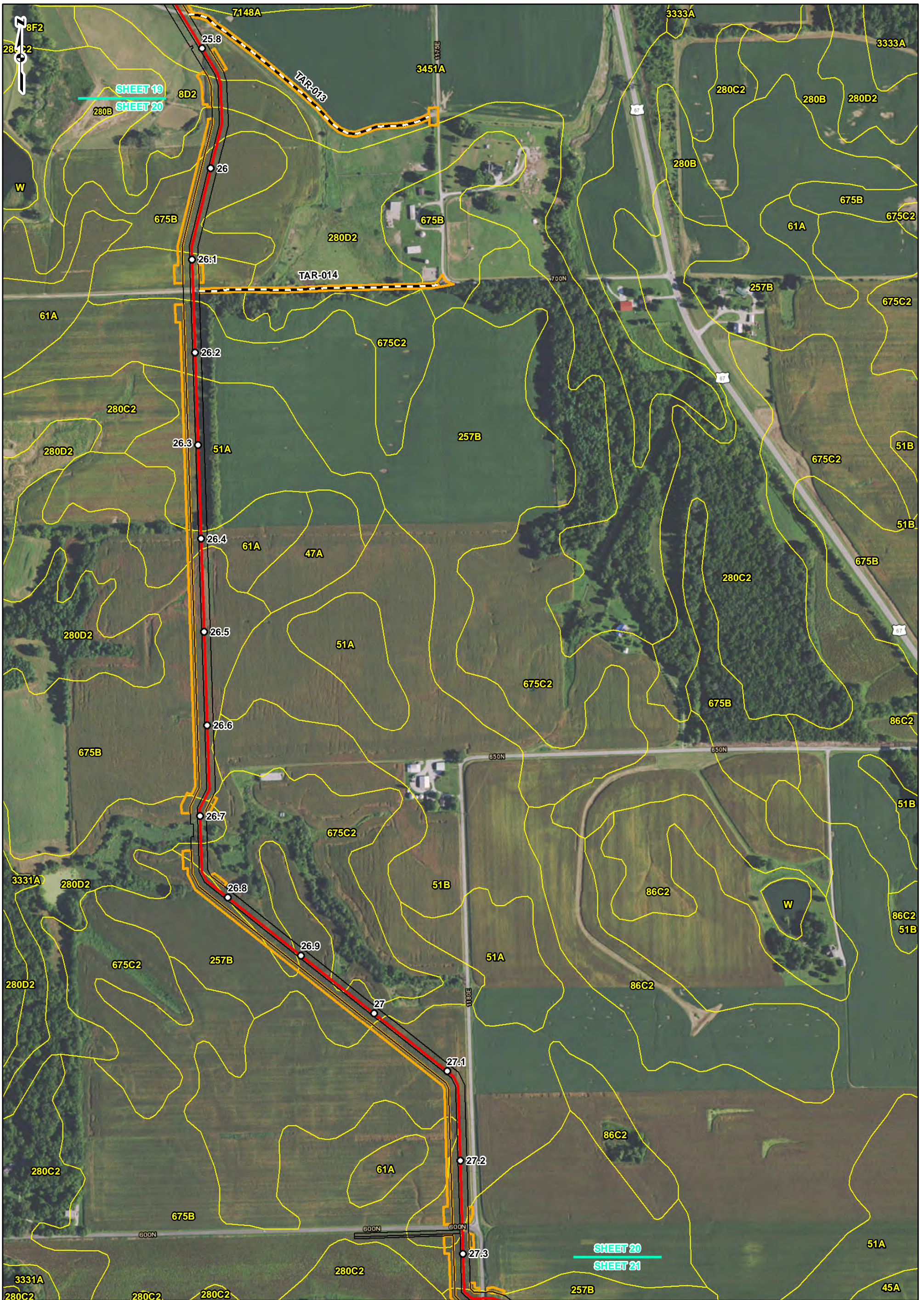

REFERENCE: ESRI WORLD IMAGERY AND TRANSPORTATION, NAIP, USDA FSA, 2014. ACCESSED 04/2017. SOIL SURVEY GEOGRAPHIC (SSURGO) DATABASE FOR ILLINOIS (2014) AND MISSOURI (2015), USDA/NRCS.

**LEGEND**

- FACILITY
- MILEPOST
- 24-INCH PIPELINE
- NORTH COUNTY EXTENSION
- ACCESS ROAD
- SOIL TYPE BOUNDARY
- PERMANENT LIMIT OF DISTURBANCE
- TEMPORARY LIMIT OF DISTURBANCE
- TEMPORARY AND PERMANENT LIMIT OF DISTURBANCE
- COUNTY BOUNDARY
- STATE BOUNDARY

0      250      500      1,000  
Feet

**SOILS MAP  
SHEET 20 OF 51**

**SPIRE STL  
PIPELINE  
PROJECT**

DRAWN BY: PMH      DATE: 4/6/2017  
 CHECKED: EFJ      APPROVED: LMF

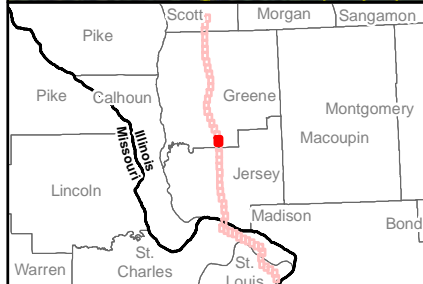
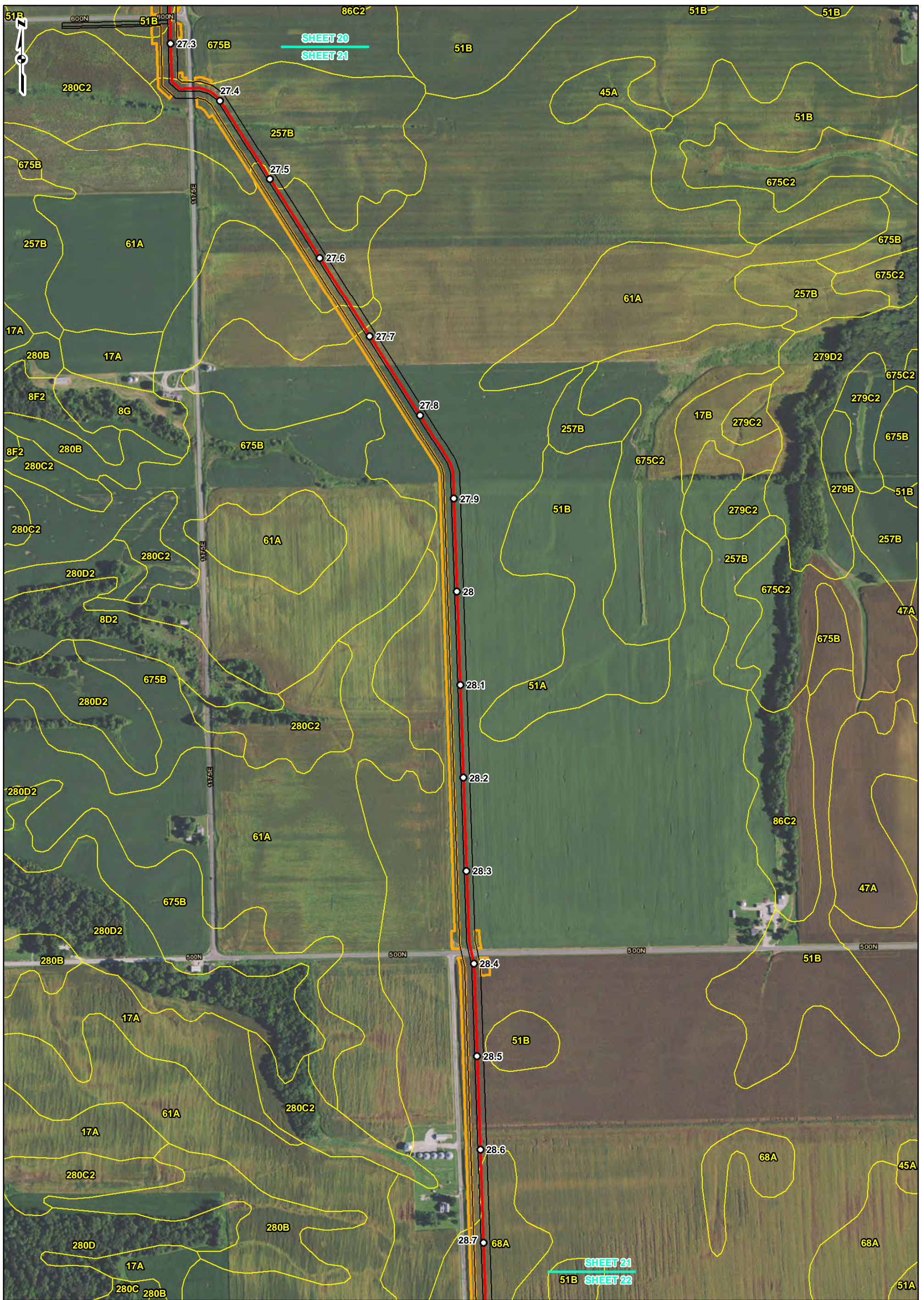

REFERENCE: ESRI WORLD IMAGERY AND TRANSPORTATION, NAIP, USDA FSA, 2014. ACCESSED 04/2017. SOIL SURVEY GEOGRAPHIC (SSURGO) DATABASE FOR ILLINOIS (2014) AND MISSOURI (2015), USDA/NRCS.

**LEGEND**

- FACILITY
- MILEPOST
- 24-INCH PIPELINE
- NORTH COUNTY EXTENSION
- ACCESS ROAD
- SOIL TYPE BOUNDARY
- PERMANENT LIMIT OF DISTURBANCE
- TEMPORARY LIMIT OF DISTURBANCE
- TEMPORARY AND PERMANENT LIMIT OF DISTURBANCE
- COUNTY BOUNDARY
- STATE BOUNDARY

0 250 500 1,000 Feet

**SOILS MAP  
SHEET 21 OF 51**

**SPIRE STL  
PIPELINE  
PROJECT**

DRAWN BY: PMH      DATE: 4/6/2017  
 CHECKED: EFJ      APPROVED: LMF

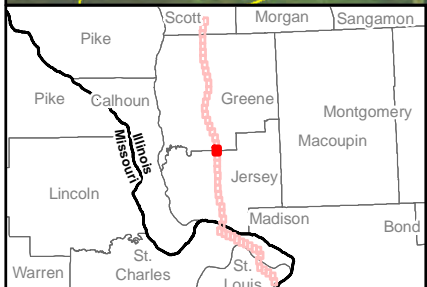
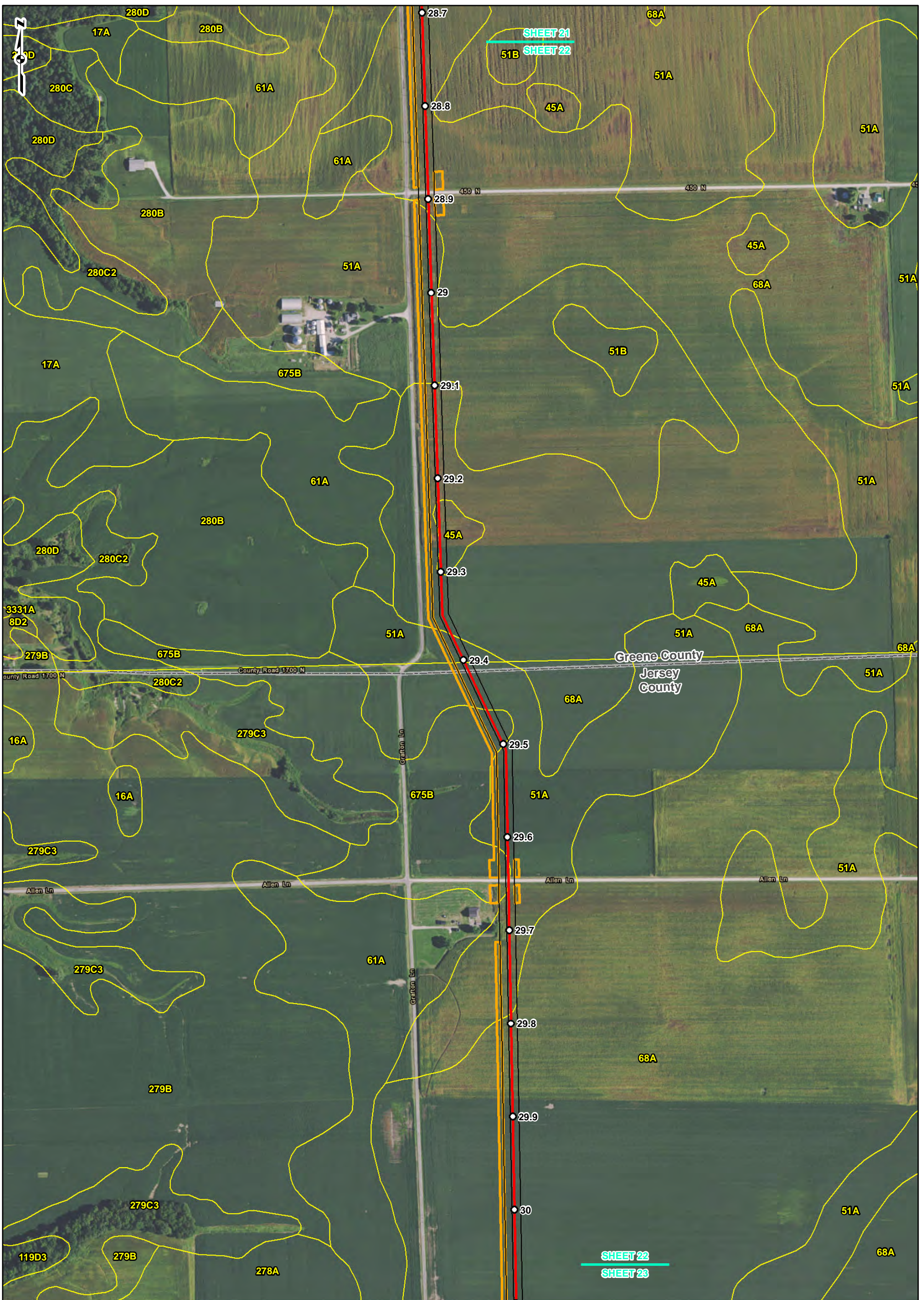

REFERENCE: ESRI WORLD IMAGERY AND TRANSPORTATION, NAIP, USDA FSA, 2014, ACCESSED 04/2017, SOIL SURVEY GEOGRAPHIC (SSURGO) DATABASE FOR ILLINOIS (2014) AND MISSOURI (2015), USDA/NRCS.

**LEGEND**

- FACILITY
- MILEPOST
- 24-INCH PIPELINE
- NORTH COUNTY EXTENSION
- ACCESS ROAD
- SOIL TYPE BOUNDARY
- PERMANENT LIMIT OF DISTURBANCE
- TEMPORARY LIMIT OF DISTURBANCE
- LIMIT OF DISTURBANCE
- COUNTY BOUNDARY
- STATE BOUNDARY

0 250 500 1,000 Feet

**SOILS MAP  
SHEET 22 OF 51**

**SPIRE STL  
PIPELINE  
PROJECT**

DRAWN BY: PMH      DATE: 4/6/2017  
 CHECKED: EFJ      APPROVED: LMF

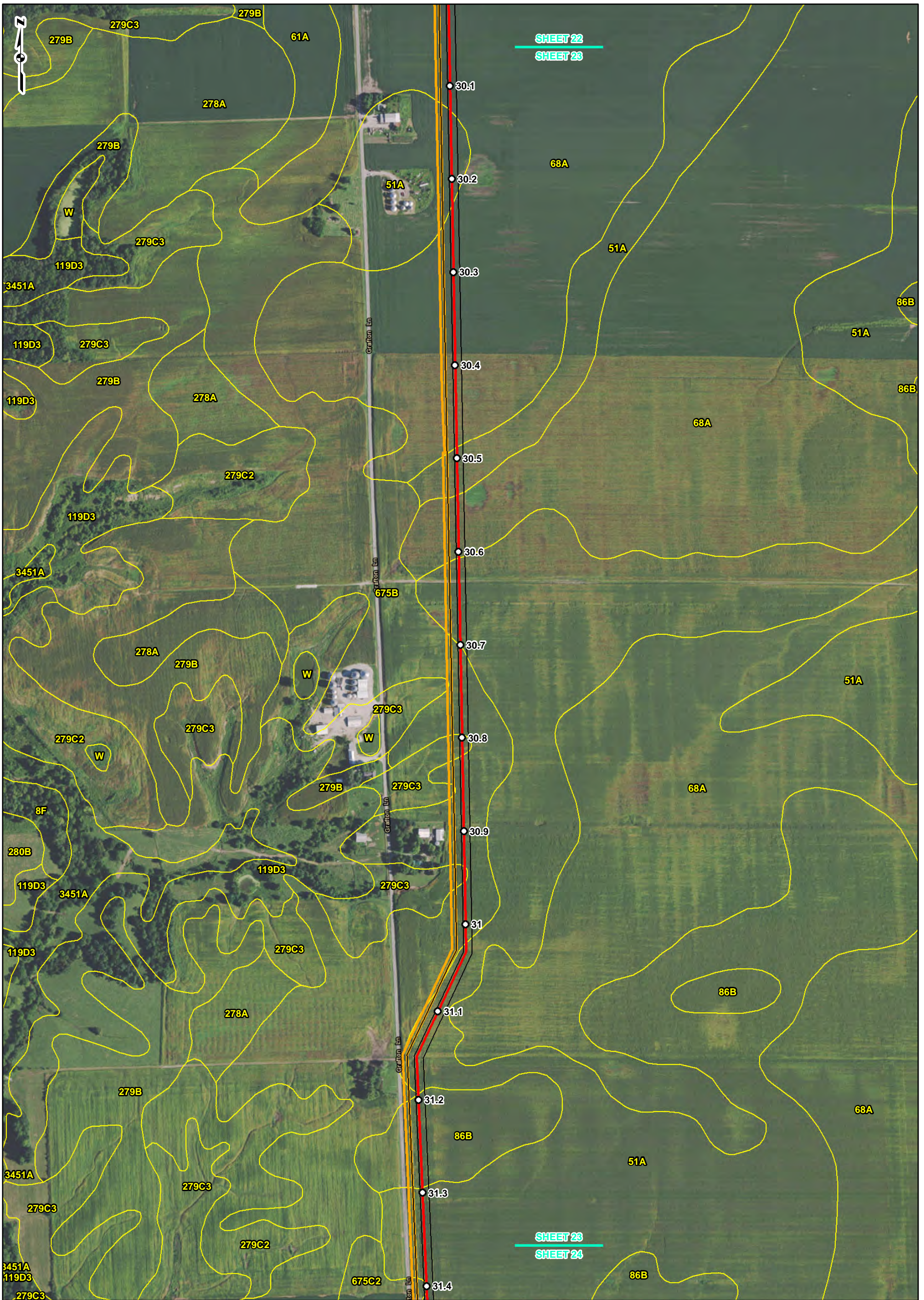

REFERENCE: ESRI WORLD IMAGERY AND TRANSPORTATION, NAIP, USDA FSA, 2014, ACCESSED 04/2017, SOIL SURVEY GEOGRAPHIC (SSURGO) DATABASE FOR ILLINOIS (2014) AND MISSOURI (2015), USDA/NRCS.

**LEGEND**

- FACILITY
- MILEPOST
- 24-INCH PIPELINE
- NORTH COUNTY EXTENSION
- ACCESS ROAD
- SOIL TYPE BOUNDARY
- PERMANENT LIMIT OF DISTURBANCE
- TEMPORARY LIMIT OF DISTURBANCE
- TEMPORARY AND PERMANENT LIMIT OF DISTURBANCE
- COUNTY BOUNDARY
- STATE BOUNDARY

0      250      500      1,000  
Feet

**SOILS MAP  
SHEET 23 OF 51**

**SPIRE STL  
PIPELINE  
PROJECT**

DRAWN BY: PMH      DATE: 4/6/2017  
CHECKED: EFJ      APPROVED: LMF

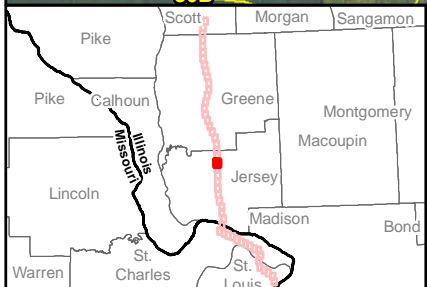
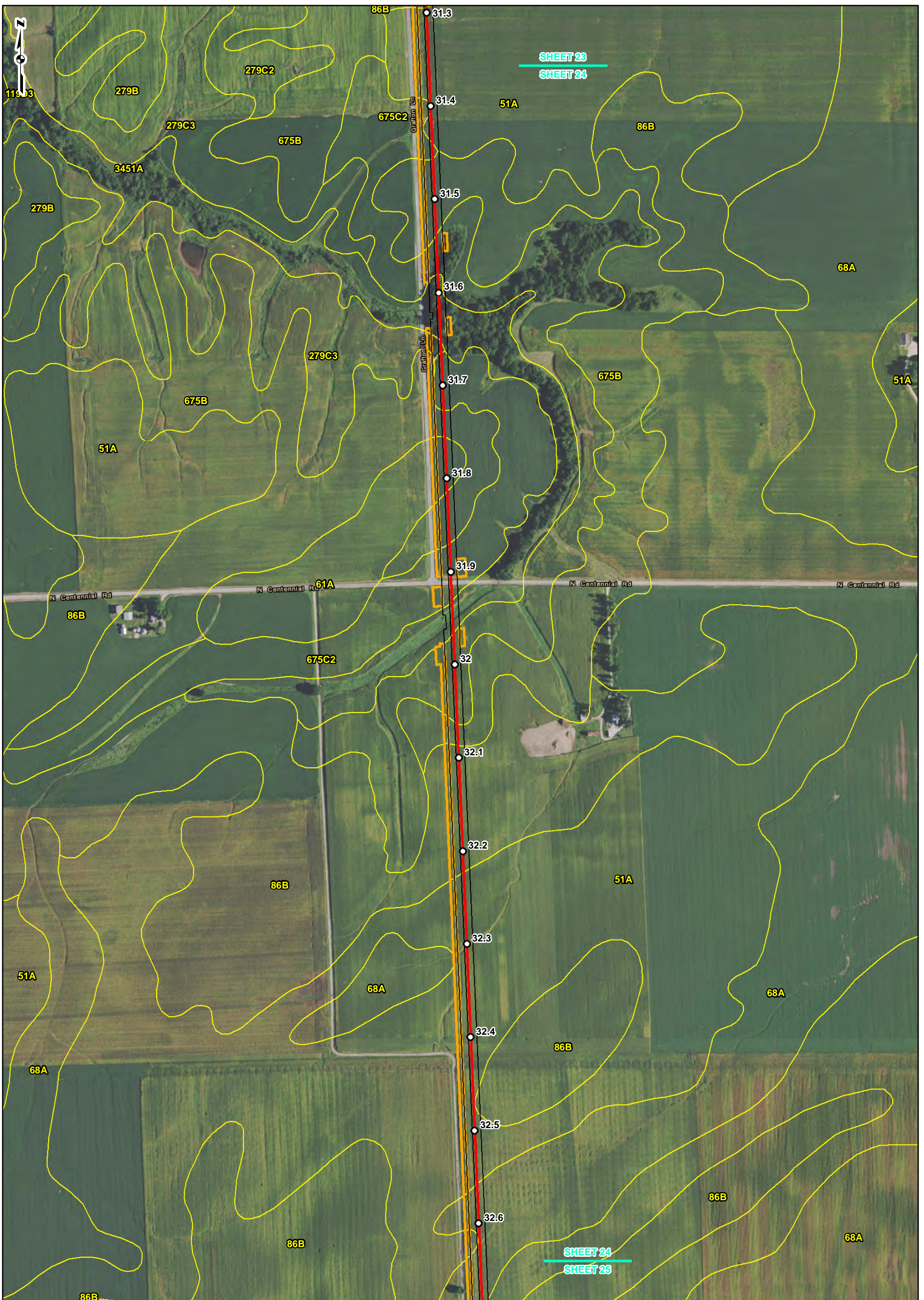

REFERENCE: ESRI WORLD IMAGERY AND TRANSPORTATION, NAIP, USDA FSA, 2014. ACCESSED 04/2017. SOIL SURVEY GEOGRAPHIC (SSURGO) DATABASE FOR ILLINOIS (2014) AND MISSOURI (2015), USDA/NRCS.

**LEGEND**

- FACILITY
- MILEPOST
- 24-INCH PIPELINE
- NORTH COUNTY EXTENSION
- ACCESS ROAD
- SOIL TYPE BOUNDARY
- PERMANENT LIMIT OF DISTURBANCE
- TEMPORARY LIMIT OF DISTURBANCE
- TEMPORARY AND PERMANENT LIMIT OF DISTURBANCE
- COUNTY BOUNDARY
- STATE BOUNDARY

0      250      500      1,000  
Feet

**SOILS MAP  
SHEET 24 OF 51**

**SPIRE STL  
PIPELINE  
PROJECT**

DRAWN BY: PMH      DATE: 4/6/2017  
CHECKED: EFJ      APPROVED: LMF

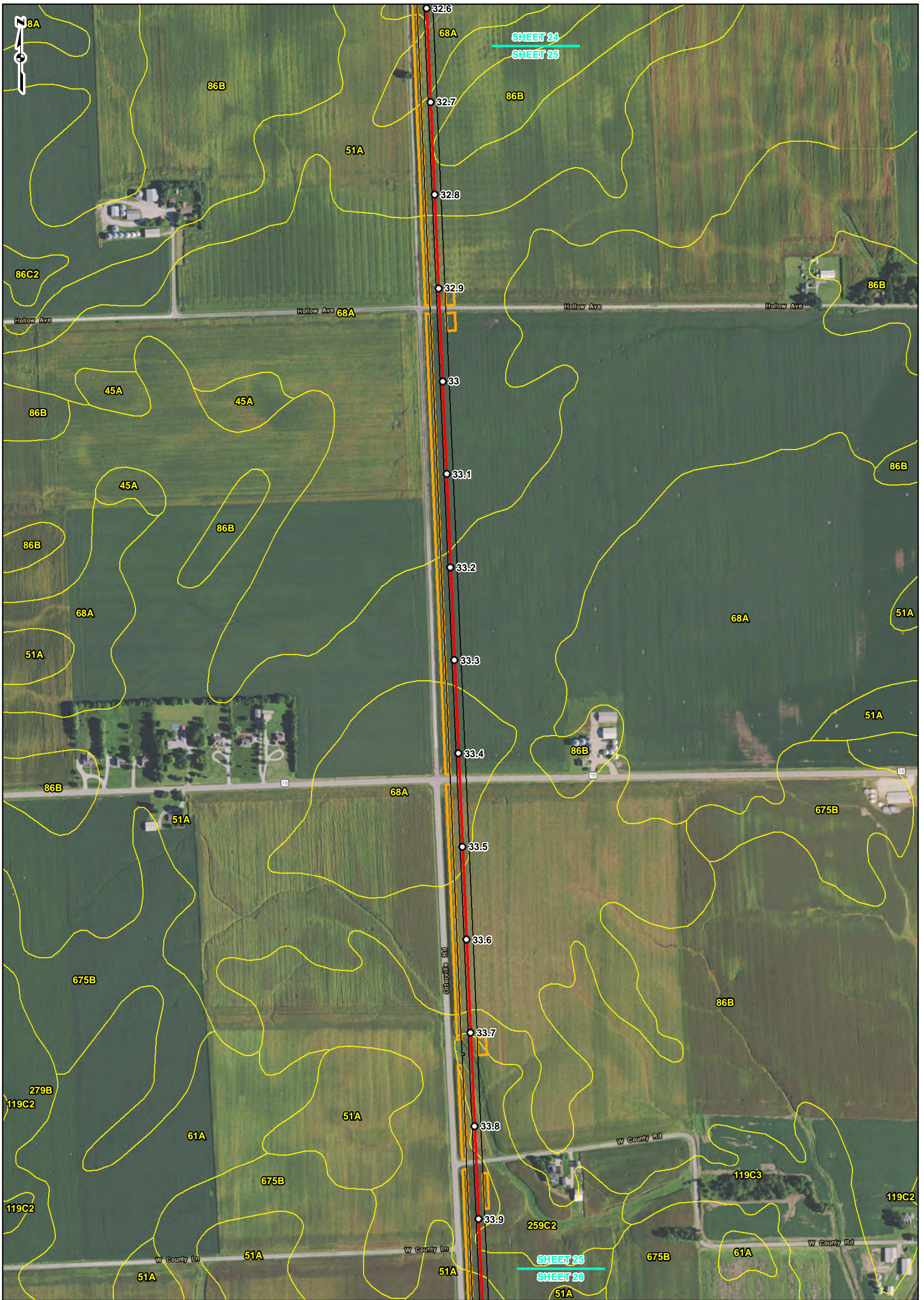

REFERENCE: ESRI WORLD IMAGERY AND TRANSPORTATION, NAIP, USDA FSA, 2014, ACCESSED 04/2017, SOIL SURVEY GEOGRAPHIC (SSURGO) DATABASE FOR ILLINOIS (2014) AND MISSOURI (2015), USDA/NRCS.

**LEGEND**

- FACILITY
- MILEPOST
- 24-INCH PIPELINE
- NORTH COUNTY EXTENSION
- ACCESS ROAD
- SOIL TYPE BOUNDARY
- PERMANENT LIMIT OF DISTURBANCE
- TEMPORARY LIMIT OF DISTURBANCE
- LIMIT OF DISTURBANCE
- COUNTY BOUNDARY
- STATE BOUNDARY

0      250      500      1,000  
Feet

**SOILS MAP  
SHEET 25 OF 51**



gal consultants

**SPIRE STL  
PIPELINE  
PROJECT**



DRAWN BY: PMH  
CHECKED: EFJ

DATE: 4/6/2017  
APPROVED: LMF

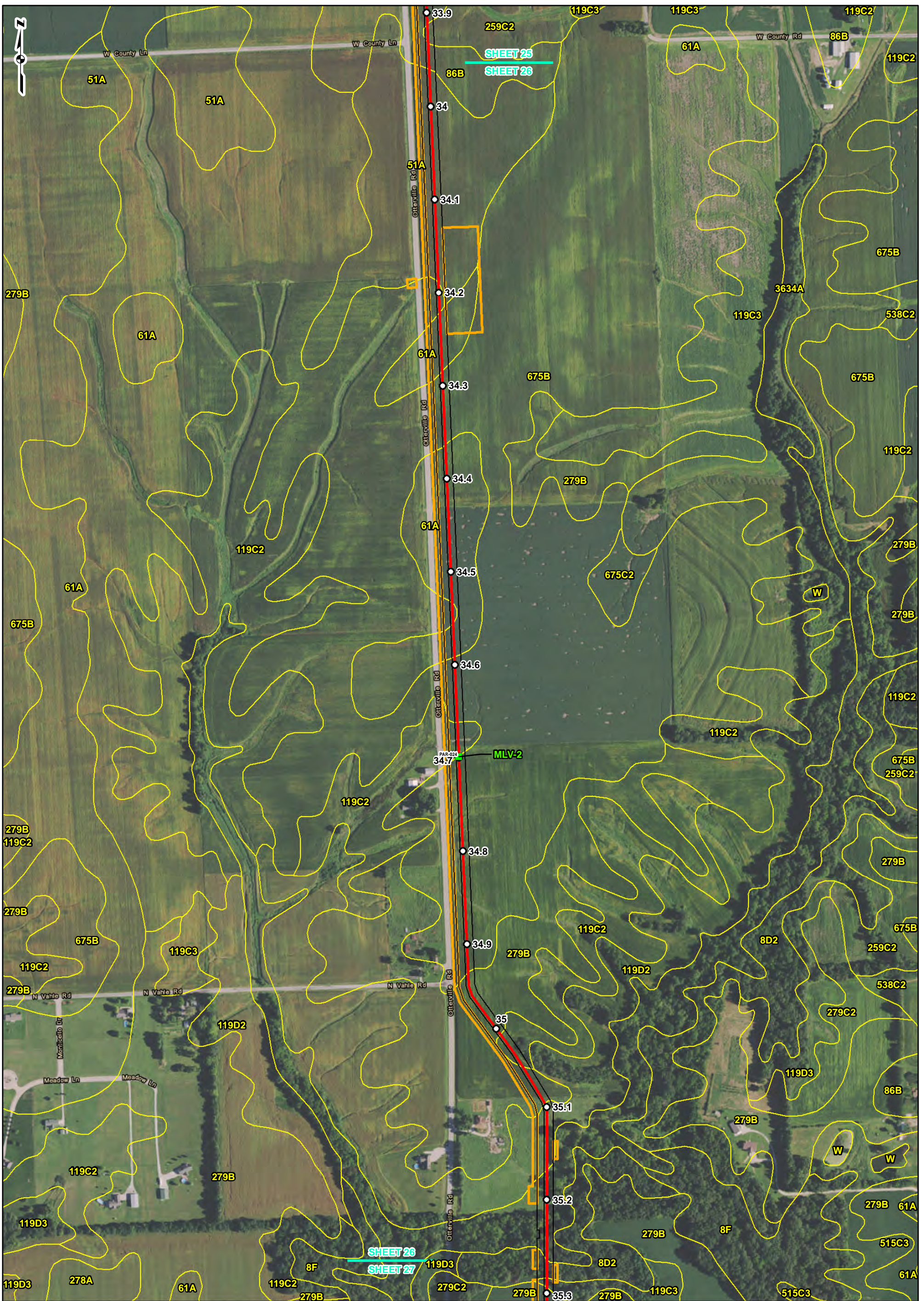

REFERENCE: ESRI WORLD IMAGERY AND TRANSPORTATION, NAIP, USDA FSA, 2014, ACCESSED 04/2017, SOIL SURVEY GEOGRAPHIC (SSURGO) DATABASE FOR ILLINOIS (2014) AND MISSOURI (2015), USDA/NRCS.

**LEGEND**

- FACILITY
- MILEPOST
- 24-INCH PIPELINE
- NORTH COUNTY EXTENSION
- ACCESS ROAD
- SOIL TYPE BOUNDARY
- PERMANENT LIMIT OF DISTURBANCE
- TEMPORARY LIMIT OF DISTURBANCE
- TEMPORARY AND PERMANENT LIMIT OF DISTURBANCE
- COUNTY BOUNDARY
- STATE BOUNDARY

0 250 500 1,000 Feet

**SOILS MAP  
SHEET 26 OF 51**

**SPIRE STL  
PIPELINE  
PROJECT**

DRAWN BY: PMH      DATE: 4/6/2017  
 CHECKED: EFJ      APPROVED: LMF



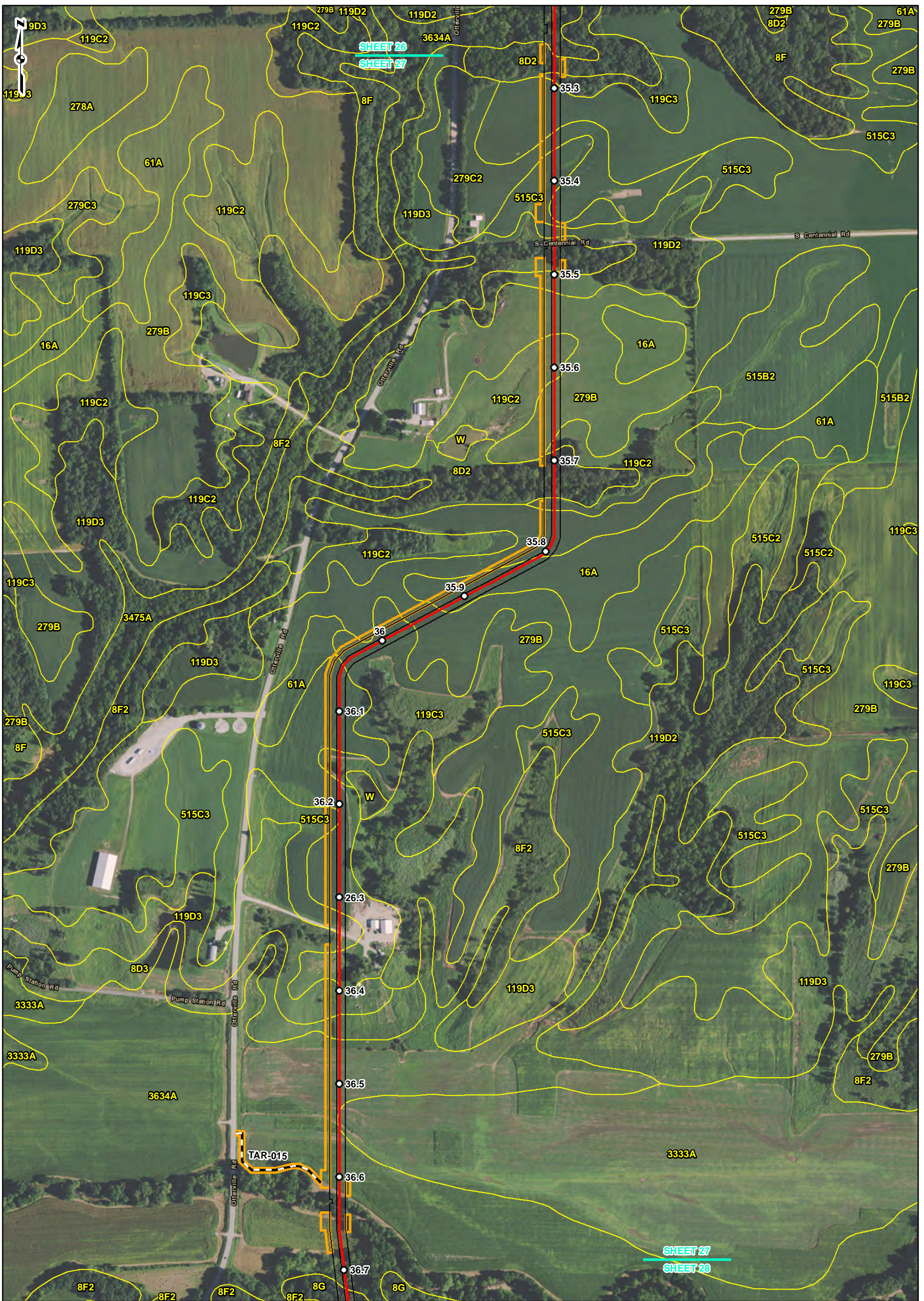

REFERENCE: ESRI WORLD IMAGERY AND TRANSPORTATION, NAIP, USDA FSA, 2014, ACCESSED 04/2017, SOIL SURVEY GEOGRAPHIC (SSURGO) DATABASE FOR ILLINOIS (2014) AND MISSOURI (2015), USDA/NRCS.

**LEGEND**

- FACILITY
- MILEPOST
- 24-INCH PIPELINE
- NORTH COUNTY EXTENSION
- ACCESS ROAD
- SOIL TYPE BOUNDARY
- PERMANENT LIMIT OF DISTURBANCE
- TEMPORARY LIMIT OF DISTURBANCE
- TEMPORARY AND PERMANENT LIMIT OF DISTURBANCE
- COUNTY BOUNDARY
- STATE BOUNDARY

0 250 500 1,000 Feet

**SOILS MAP  
SHEET 27 OF 51**

**SPiRE STL  
PIPELINE  
PROJECT**

DRAWN BY: PMH      DATE: 4/6/2017  
 CHECKED: EFJ      APPROVED: LMF

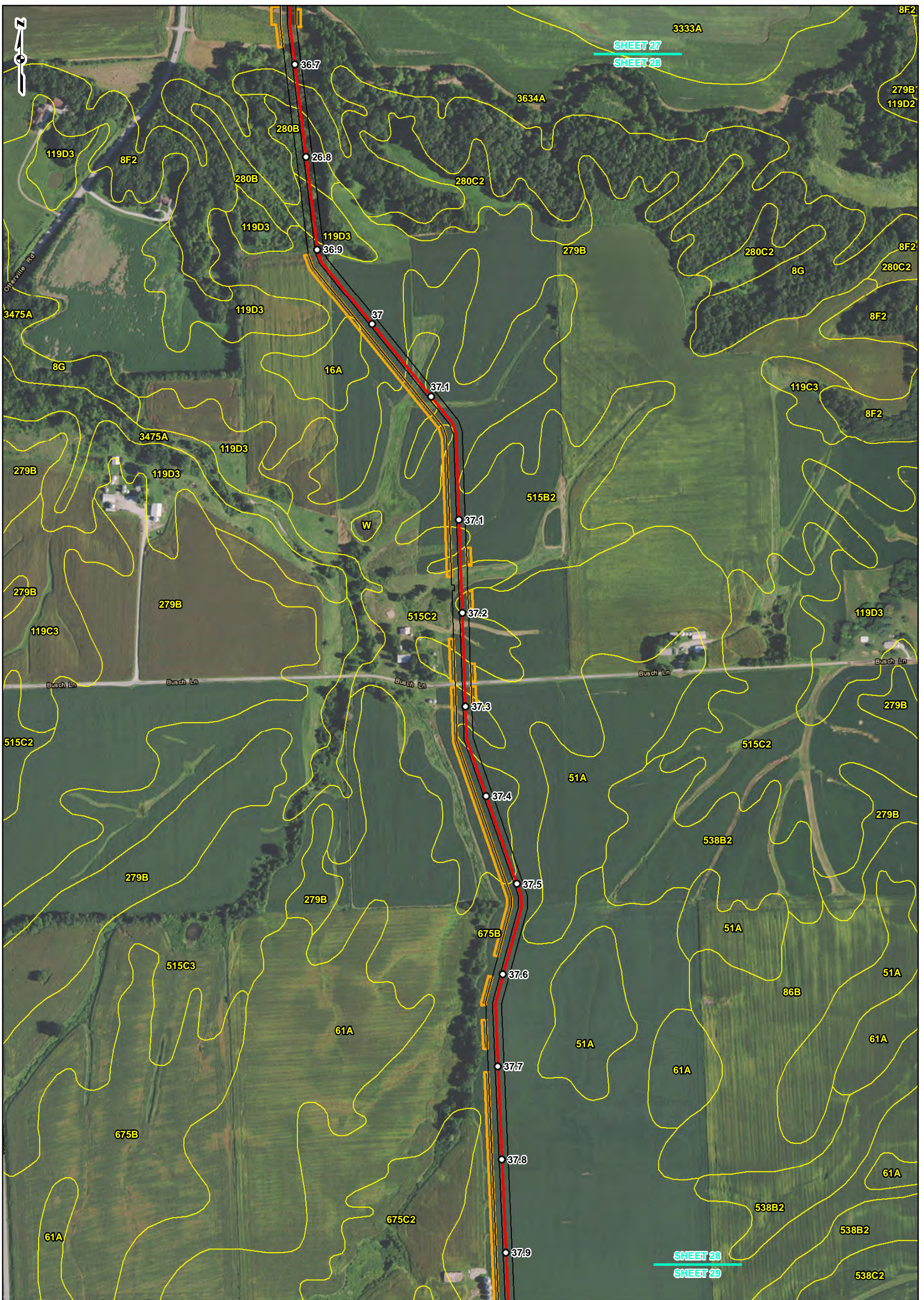

REFERENCE: ESRI WORLD IMAGERY AND TRANSPORTATION, NAIP, USDA FSA, 2014, ACCESSED 04/2017, SOIL SURVEY GEOGRAPHIC (SSURGO) DATABASE FOR ILLINOIS (2014) AND MISSOURI (2015), USDA/NRCS.

**LEGEND**

- FACILITY
- MILEPOST
- 24-INCH PIPELINE
- NORTH COUNTY EXTENSION
- ACCESS ROAD
- SOIL TYPE BOUNDARY
- PERMANENT LIMIT OF DISTURBANCE
- TEMPORARY LIMIT OF DISTURBANCE
- TEMPORARY AND PERMANENT LIMIT OF DISTURBANCE
- COUNTY BOUNDARY
- STATE BOUNDARY

0      250      500      1,000  
Feet

**SOILS MAP**  
**SHEET 28 OF 51**

**SPIRE STL**  
**PIPELINE**  
**PROJECT**

DRAWN BY: PMH      DATE: 4/6/2017  
CHECKED: EFJ      APPROVED: LMF

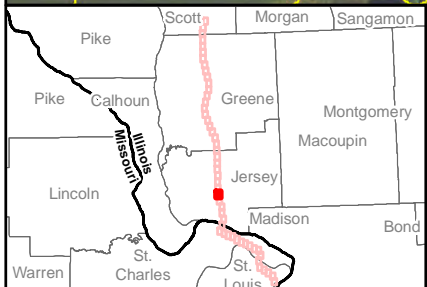
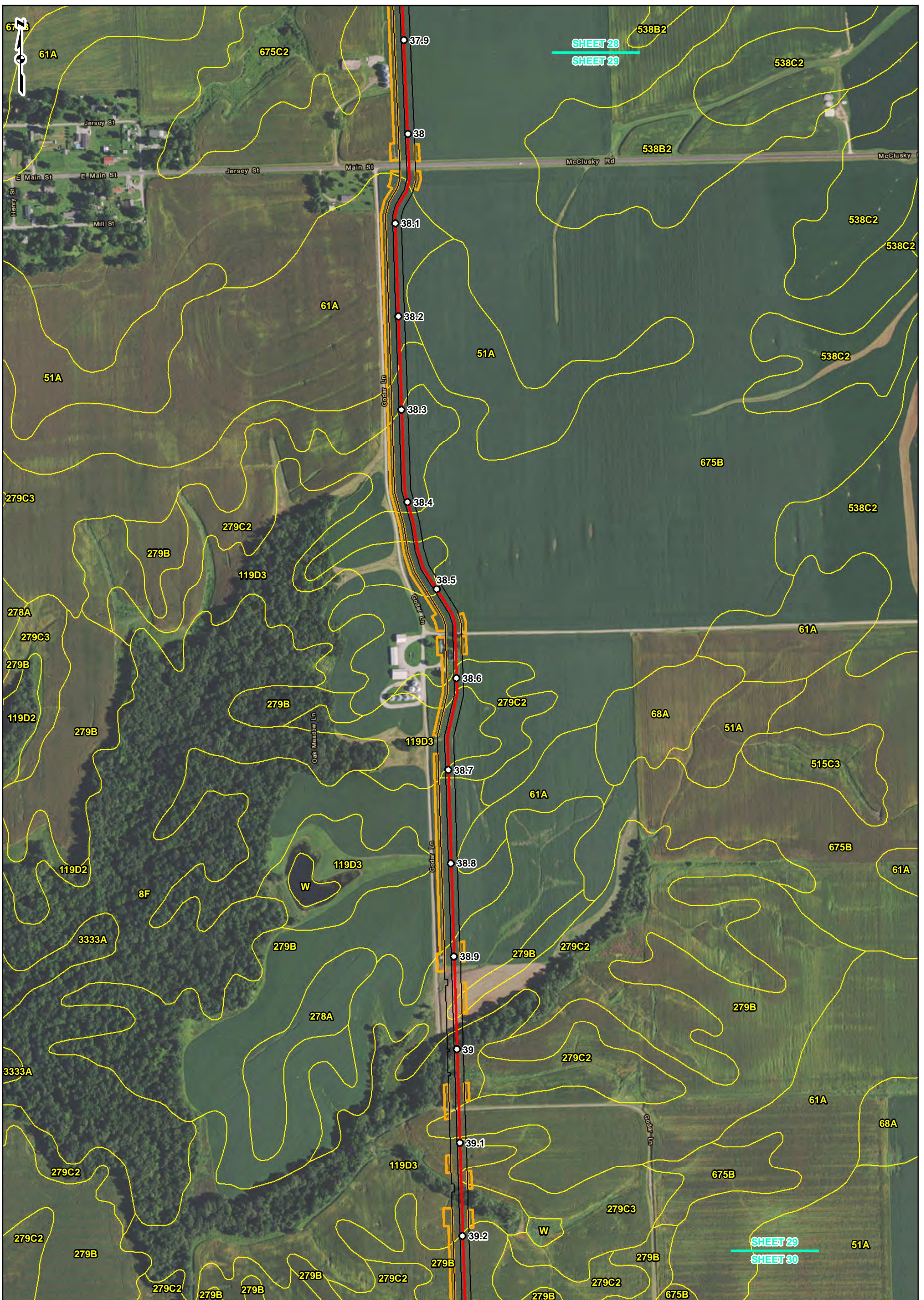

REFERENCE: ESRI WORLD IMAGERY AND TRANSPORTATION, NAIP, USDA FSA, 2014, ACCESSED 04/2017, SOIL SURVEY GEOGRAPHIC (SSURGO) DATABASE FOR ILLINOIS (2014) AND MISSOURI (2015), USDA/NRCS.

**LEGEND**

- FACILITY
- MILEPOST
- 24-INCH PIPELINE
- NORTH COUNTY EXTENSION
- ACCESS ROAD
- SOIL TYPE BOUNDARY
- PERMANENT LIMIT OF DISTURBANCE
- TEMPORARY LIMIT OF DISTURBANCE
- LIMIT OF DISTURBANCE
- COUNTY BOUNDARY
- STATE BOUNDARY

0      250      500      1,000  
Feet

**SOILS MAP  
SHEET 29 OF 51**

**SPIRE STL  
PIPELINE  
PROJECT**

DRAWN BY: PMH      DATE: 4/6/2017  
 CHECKED: EFJ      APPROVED: LMF

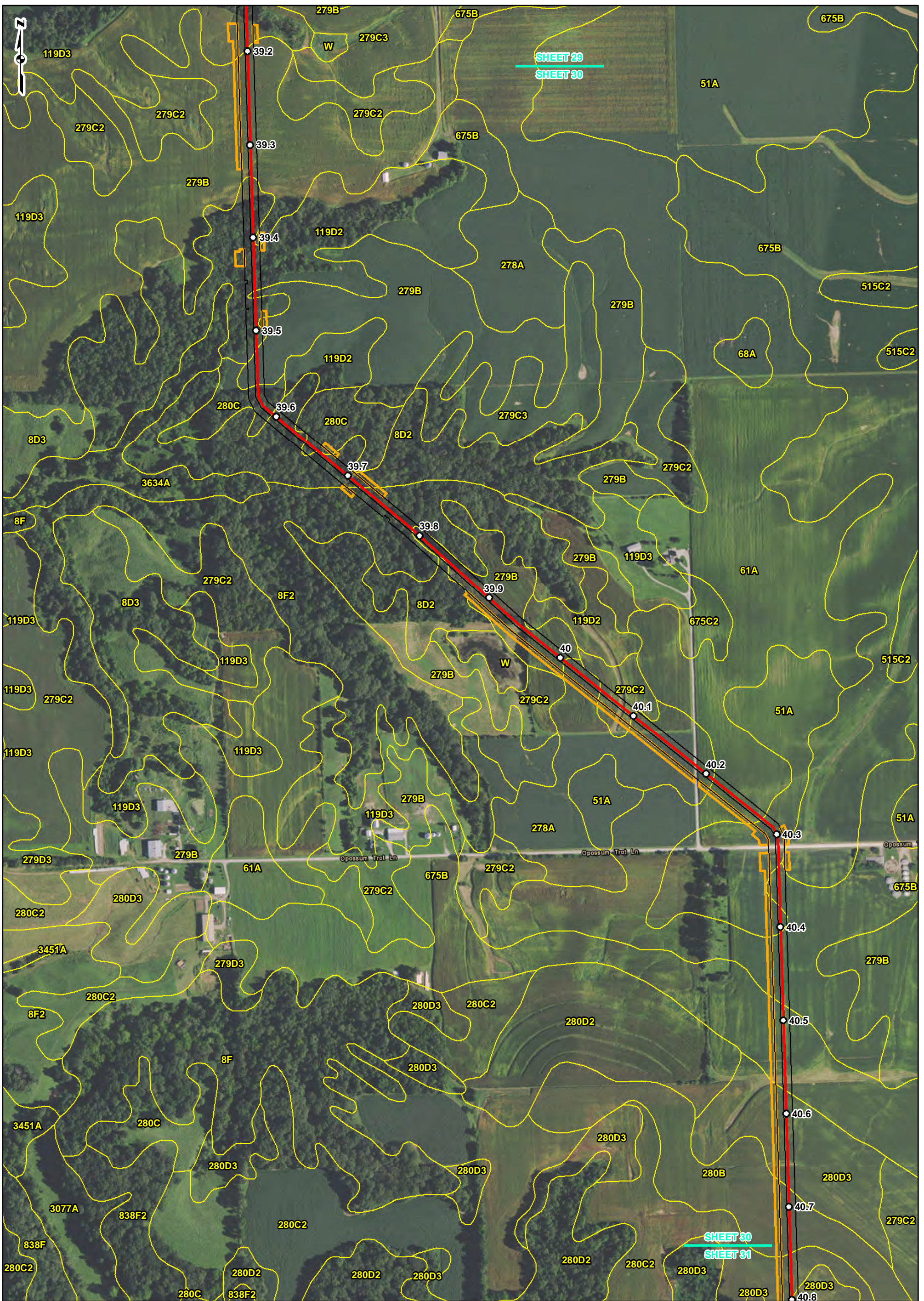

REFERENCE: ESRI WORLD IMAGERY AND TRANSPORTATION, NAIP, USDA FSA, 2014. ACCESSED 04/2017. SOIL SURVEY GEOGRAPHIC (SSURGO) DATABASE FOR ILLINOIS (2014) AND MISSOURI (2015), USDA/NRCS.

LEGEND	
	FACILITY
	MILEPOST
	24-INCH PIPELINE
	NORTH COUNTY EXTENSION
	ACCESS ROAD
	SOIL TYPE BOUNDARY
	PERMANENT LIMIT OF DISTURBANCE
	TEMPORARY LIMIT OF DISTURBANCE
	TEMPORARY AND PERMANENT LIMIT OF DISTURBANCE
	COUNTY BOUNDARY
	STATE BOUNDARY

0 250 500 1,000 Feet

**SOILS MAP**  
**SHEET 30 OF 51**

**SPIRE STL PIPELINE PROJECT**

DRAWN BY: PMH      DATE: 4/6/2017  
CHECKED: EFJ      APPROVED: LMF

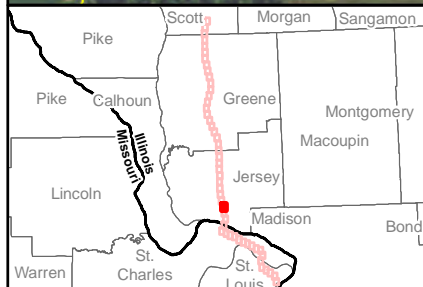
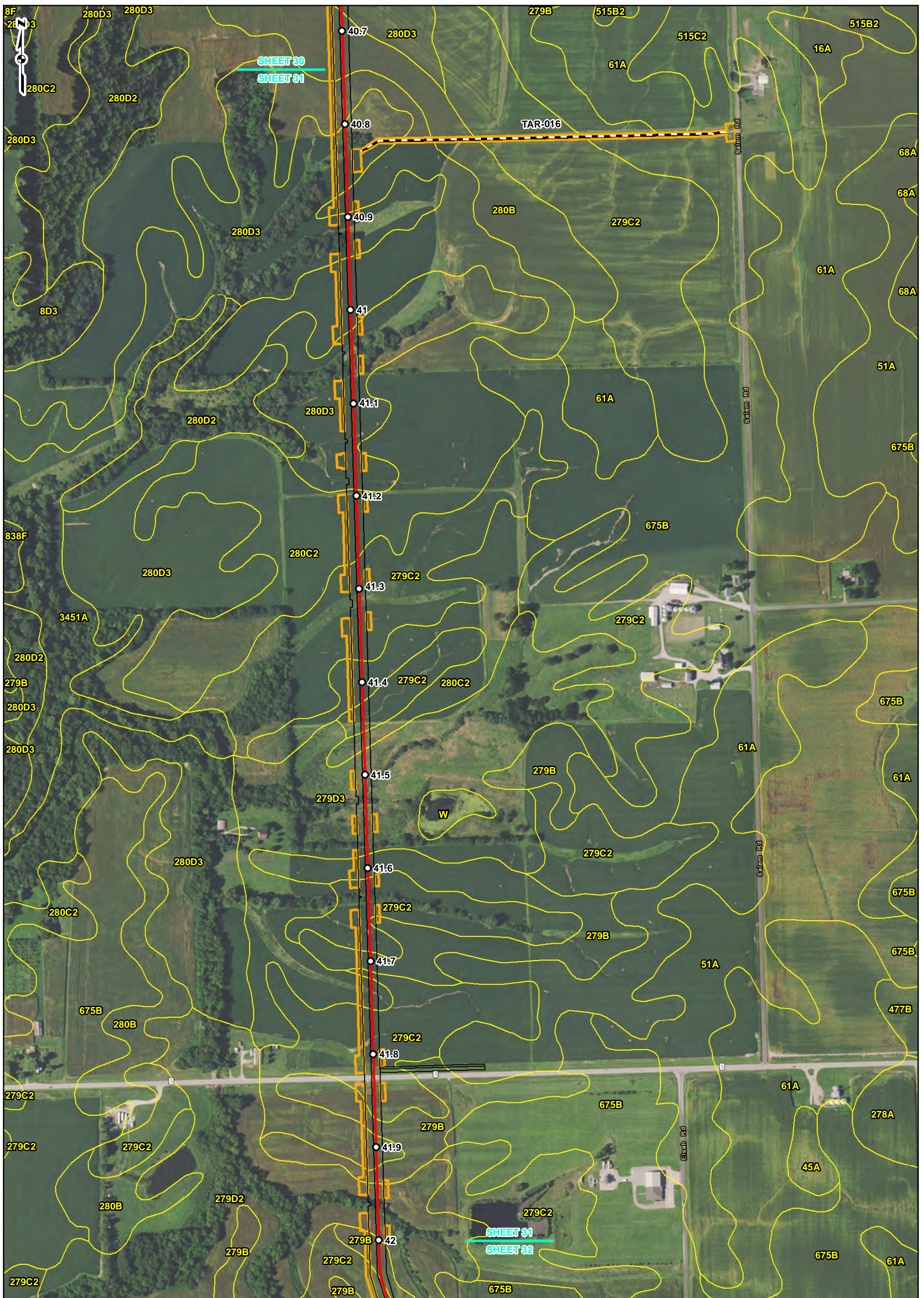

REFERENCE: ESRI WORLD IMAGERY AND TRANSPORTATION, NAIP, USDA FSA, 2014. ACCESSED 04/2017. SOIL SURVEY GEOGRAPHIC (SSURGO) DATABASE FOR ILLINOIS (2014) AND MISSOURI (2015), USDA/NRCS.

**LEGEND**

- FACILITY
- MILEPOST
- 24-INCH PIPELINE
- NORTH COUNTY EXTENSION
- ACCESS ROAD
- SOIL TYPE BOUNDARY
- PERMANENT LIMIT OF DISTURBANCE
- TEMPORARY LIMIT OF DISTURBANCE
- TEMPORARY AND PERMANENT LIMIT OF DISTURBANCE
- COUNTY BOUNDARY
- STATE BOUNDARY

0      250      500      1,000  
Feet

**SOILS MAP  
SHEET 31 OF 51**

**SPIRE STL  
PIPELINE  
PROJECT**

DRAWN BY: PMH      DATE: 4/6/2017  
 CHECKED: EFJ      APPROVED: LMF

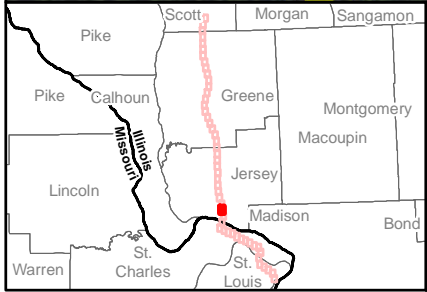
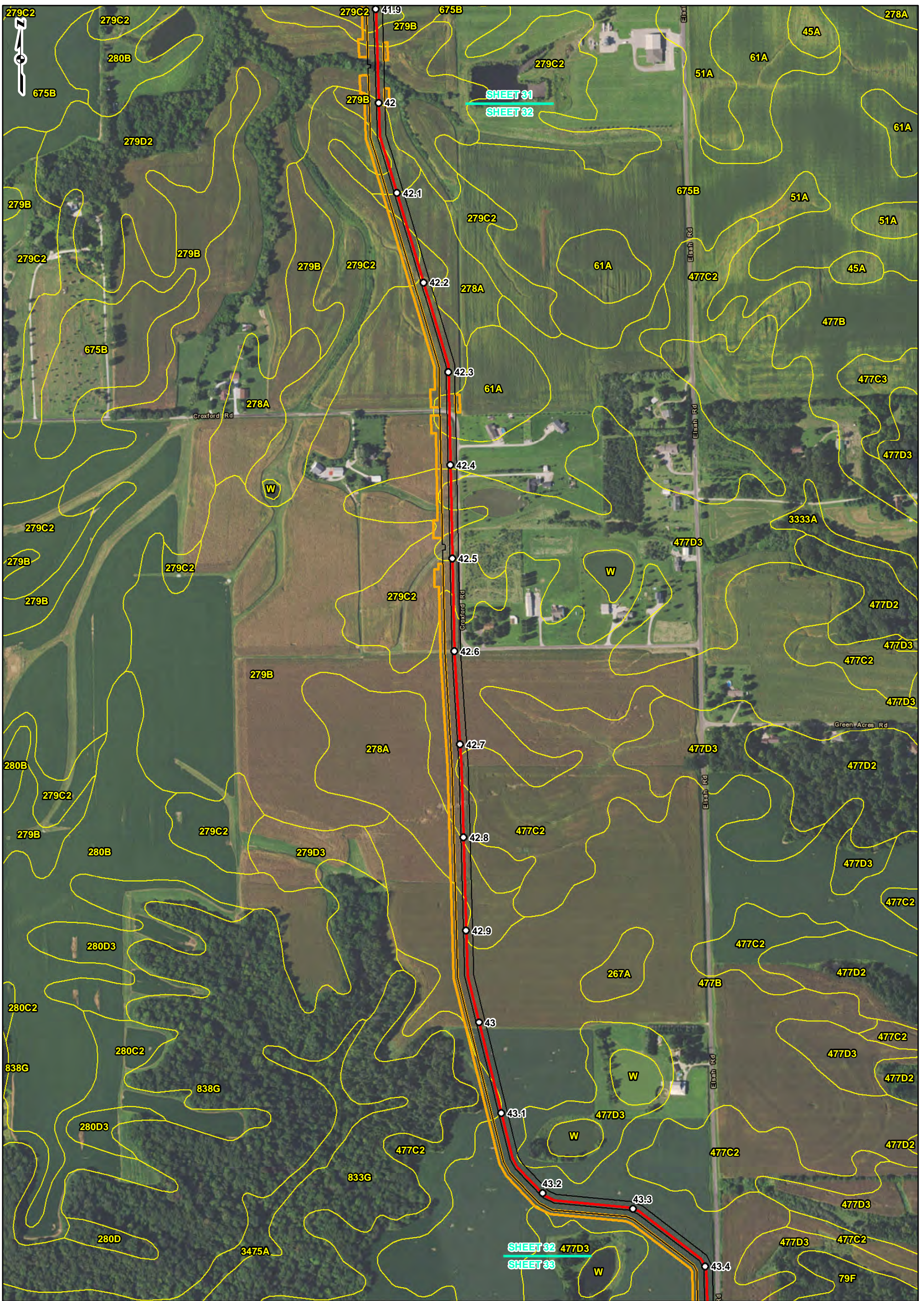

REFERENCE: ESRI WORLD IMAGERY AND TRANSPORTATION, NAI, USDA FSA, 2014. ACCESSED 04/2017. SOIL SURVEY GEOGRAPHIC (SSURGO) DATABASE FOR ILLINOIS (2014) AND MISSOURI (2015), USDA/NRCS.

LEGEND	
	FACILITY
	MILEPOST
	24-INCH PIPELINE
	NORTH COUNTY EXTENSION
	ACCESS ROAD
	SOIL TYPE BOUNDARY
	PERMANENT LIMIT OF DISTURBANCE
	TEMPORARY LIMIT OF DISTURBANCE
	TEMPORARY AND PERMANENT LIMIT OF DISTURBANCE
	COUNTY BOUNDARY
	STATE BOUNDARY

0      250      500      1,000  
Feet

**SOILS MAP  
SHEET 32 OF 51**

**SPIRE STL  
PIPELINE  
PROJECT**

gal consultants

spire

DRAWN BY: PMH      DATE: 4/6/2017  
 CHECKED: EFJ      APPROVED: LMF

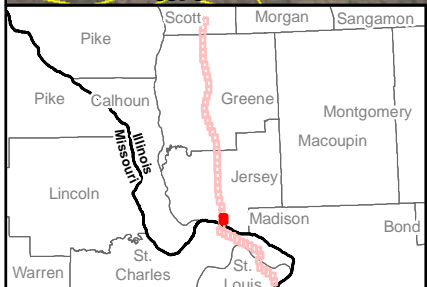
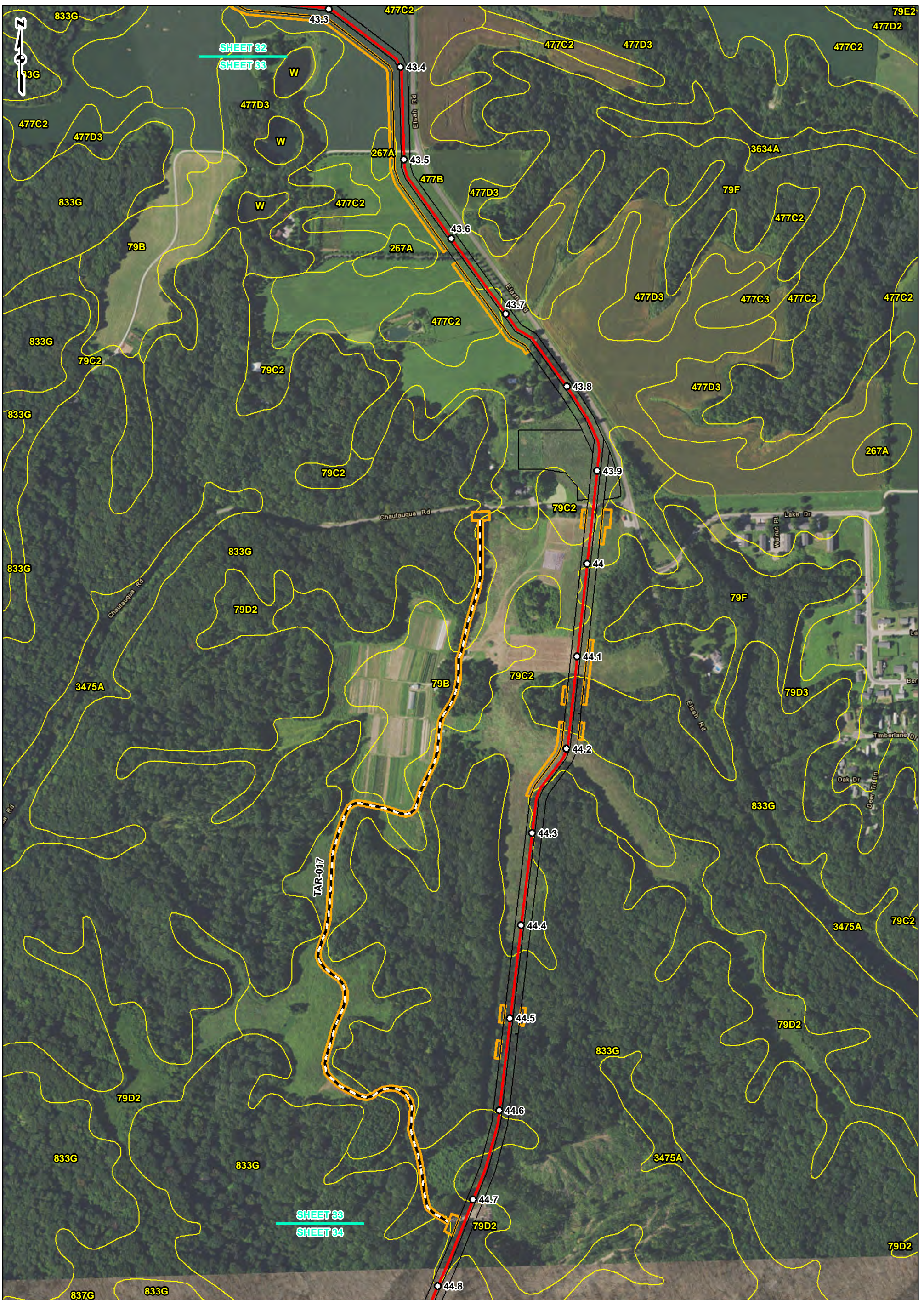

REFERENCE: ESRI WORLD IMAGERY AND TRANSPORTATION, NIP, USDA FSA, 2014, ACCESSED 04/2017, SOIL SURVEY GEOGRAPHIC (SSURGO) DATABASE FOR ILLINOIS (2014) AND MISSOURI (2015), USDA/NRCS.

**LEGEND**

- FACILITY
- MILEPOST
- 24-INCH PIPELINE
- NORTH COUNTY EXTENSION
- ACCESS ROAD
- SOIL TYPE BOUNDARY
- PERMANENT LIMIT OF DISTURBANCE
- TEMPORARY LIMIT OF DISTURBANCE
- TEMPORARY AND PERMANENT LIMIT OF DISTURBANCE
- COUNTY BOUNDARY
- STATE BOUNDARY

0 250 500 1,000 Feet

**SOILS MAP  
SHEET 33 OF 51**

**SPIRE STL  
PIPELINE  
PROJECT**

DRAWN BY: PMH      DATE: 4/6/2017  
 CHECKED: EFJ      APPROVED: LMF

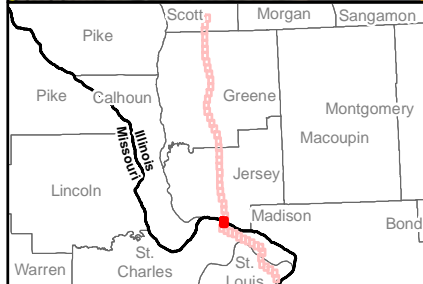

REFERENCE: ESRI WORLD IMAGERY AND TRANSPORTATION, NAIP, USDA FSA, 2014, ACCESSED 04/2017, SOIL SURVEY GEOGRAPHIC (SSURGO) DATABASE FOR ILLINOIS (2014) AND MISSOURI (2015), USDA/NRCS.

**LEGEND**

- FACILITY
- MILEPOST
- 24-INCH PIPELINE
- NORTH COUNTY EXTENSION
- ACCESS ROAD
- SOIL TYPE BOUNDARY
- PERMANENT LIMIT OF DISTURBANCE
- TEMPORARY LIMIT OF DISTURBANCE
- TEMPORARY AND PERMANENT LIMIT OF DISTURBANCE
- COUNTY BOUNDARY
- STATE BOUNDARY

0      250      500      1,000  
Feet

**SOILS MAP  
SHEET 34 OF 51**

**SPIRE STL  
PIPELINE  
PROJECT**

DRAWN BY: PMH      DATE: 4/6/2017  
 CHECKED: EFJ      APPROVED: LMF



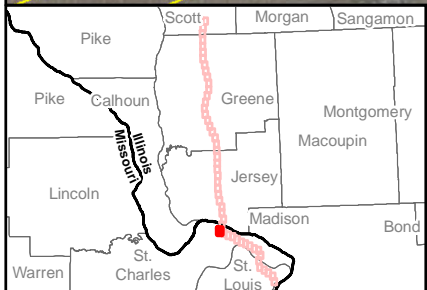

REFERENCE: ESRI WORLD IMAGERY AND TRANSPORTATION, NAIP, USDA FSA, 2014, ACCESSED 04/2017, SOIL SURVEY GEOGRAPHIC (SSURGO) DATABASE FOR ILLINOIS (2014) AND MISSOURI (2015), USDA/NRCS.

**LEGEND**

- FACILITY
- MILEPOST
- 24-INCH PIPELINE
- NORTH COUNTY EXTENSION
- ACCESS ROAD
- SOIL TYPE BOUNDARY
- PERMANENT LIMIT OF DISTURBANCE
- TEMPORARY LIMIT OF DISTURBANCE
- TEMPORARY AND PERMANENT LIMIT OF DISTURBANCE
- COUNTY BOUNDARY
- STATE BOUNDARY

0      250      500      1,000  
Feet

**SOILS MAP  
SHEET 35 OF 51**

**SPIRE STL  
PIPELINE  
PROJECT**

DRAWN BY: PMH      DATE: 4/6/2017  
CHECKED: EFJ      APPROVED: LMF

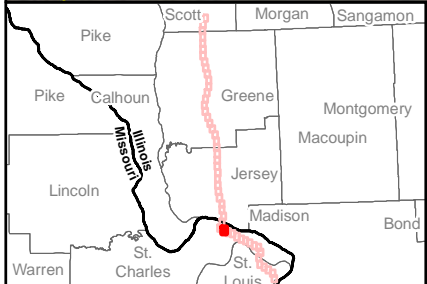
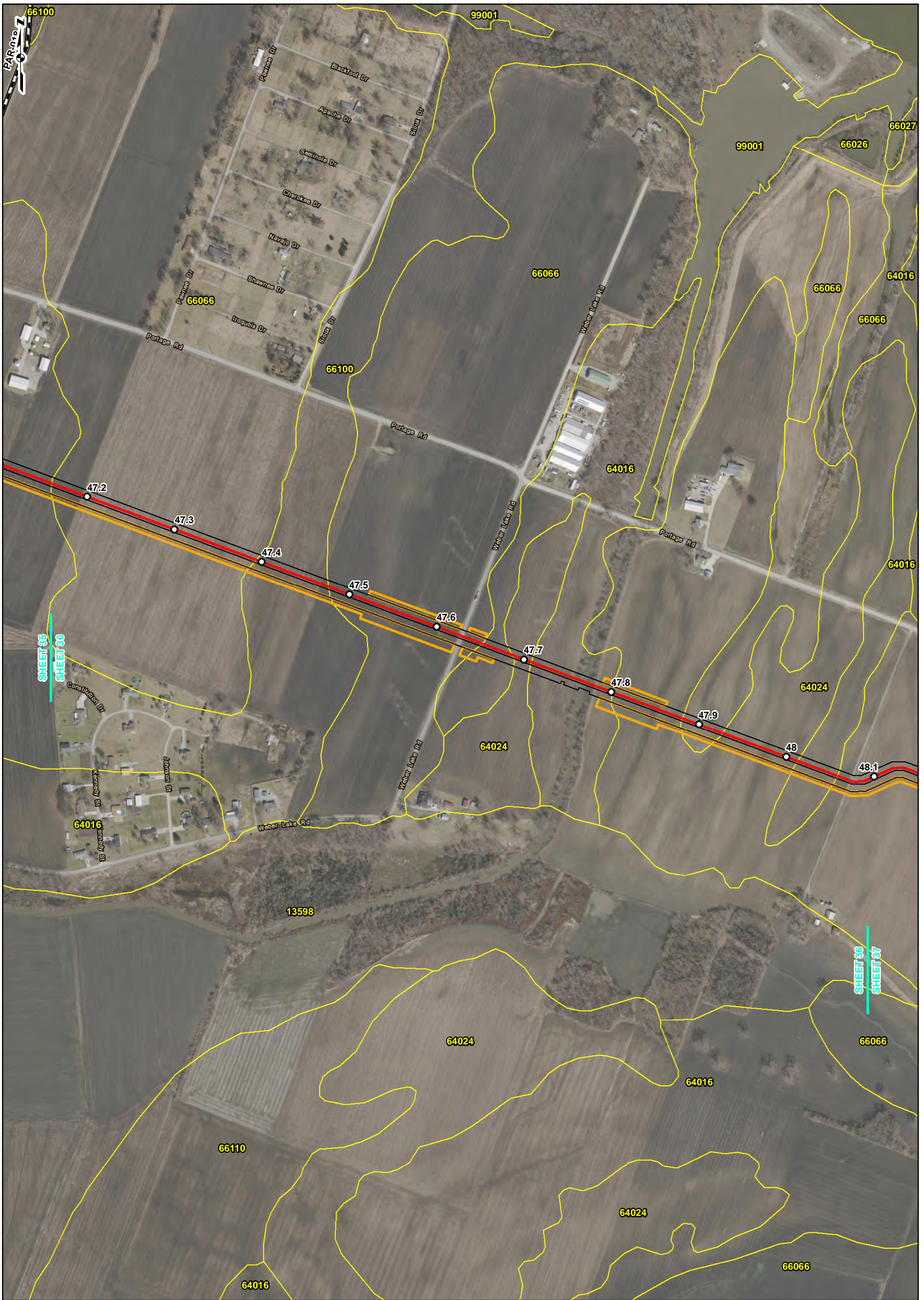

REFERENCE: ESRI WORLD IMAGERY AND TRANSPORTATION, NAD, USDA FSA, 2014. ACCESSED 04/2017. SOIL SURVEY GEOGRAPHIC (SSURGO) DATABASE FOR ILLINOIS (2014) AND MISSOURI (2015), USDA/NRCS.

**LEGEND**

- FACILITY
- MILEPOST
- 24-INCH PIPELINE
- NORTH COUNTY EXTENSION
- ACCESS ROAD
- SOIL TYPE BOUNDARY
- PERMANENT LIMIT OF DISTURBANCE
- TEMPORARY LIMIT OF DISTURBANCE
- TEMPORARY AND PERMANENT LIMIT OF DISTURBANCE
- COUNTY BOUNDARY
- STATE BOUNDARY

0      250      500      1,000  
Feet

**SOILS MAP  
SHEET 36 OF 51**

**SPIRE STL  
PIPELINE  
PROJECT**

DRAWN BY: PMH      DATE: 4/6/2017  
CHECKED: EFJ      APPROVED: LMF

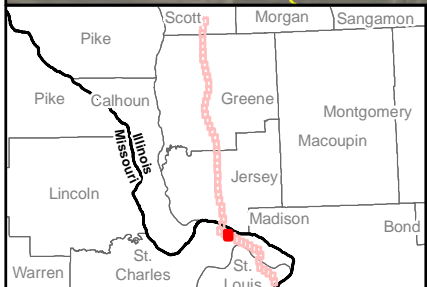
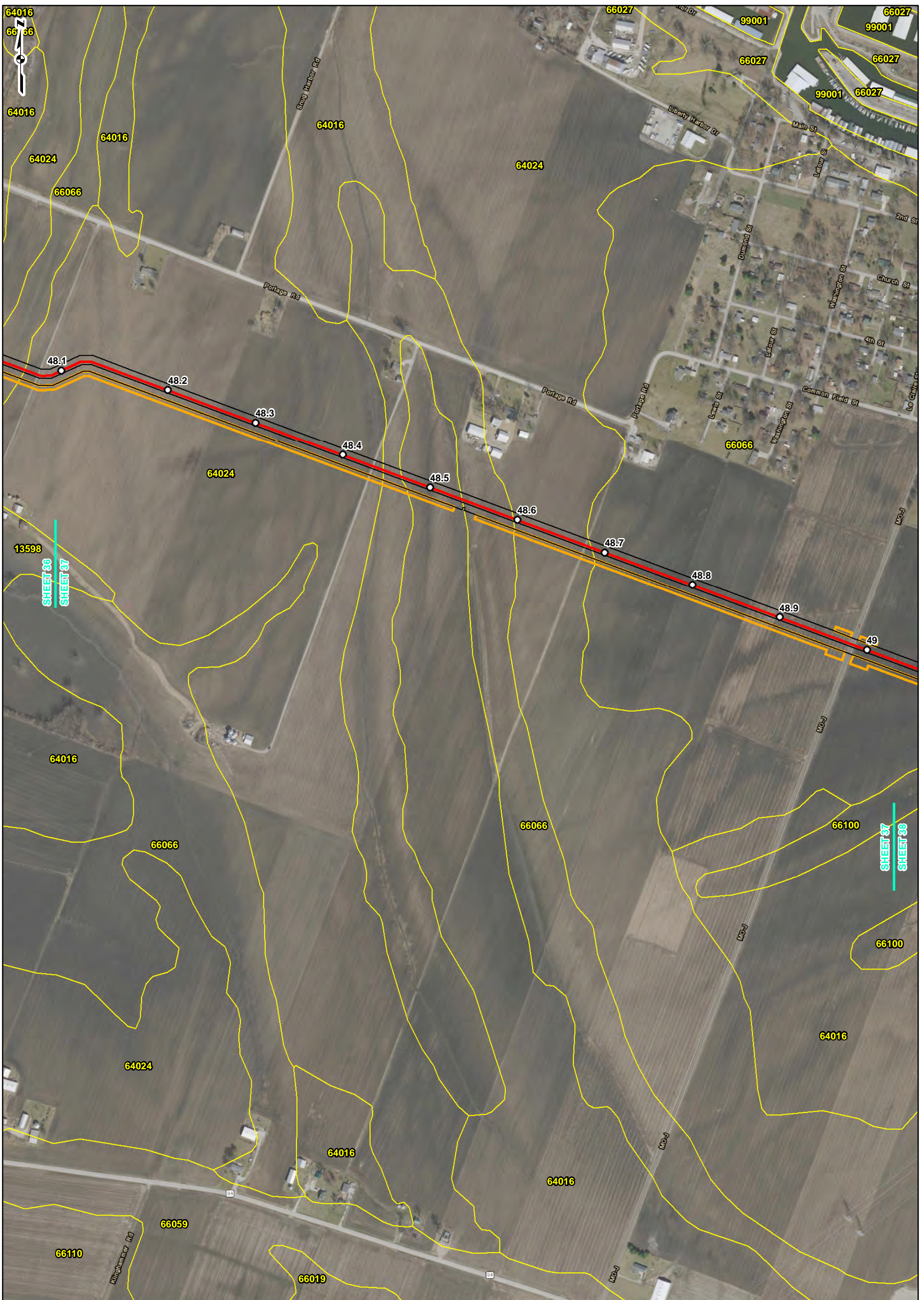

REFERENCE: ESRI WORLD IMAGERY AND TRANSPORTATION, NAIP, USDA FSA, 2014, ACCESSED 04/2017, SOIL SURVEY GEOGRAPHIC (SSURGO) DATABASE FOR ILLINOIS (2014) AND MISSOURI (2015), USDA/NRCS.

**LEGEND**

- FACILITY
- MILEPOST
- 24-INCH PIPELINE
- NORTH COUNTY EXTENSION
- ACCESS ROAD
- SOIL TYPE BOUNDARY
- PERMANENT LIMIT OF DISTURBANCE
- TEMPORARY LIMIT OF DISTURBANCE
- LIMIT OF DISTURBANCE
- COUNTY BOUNDARY
- STATE BOUNDARY

0      250      500      1,000  
Feet

**SOILS MAP  
SHEET 37 OF 51**

**SPIRE STL  
PIPELINE  
PROJECT**

DRAWN BY: PMH      DATE: 4/6/2017  
CHECKED: EFJ      APPROVED: LMF



SHEET 37  
SHEET 38

SHEET 38  
SHEET 39

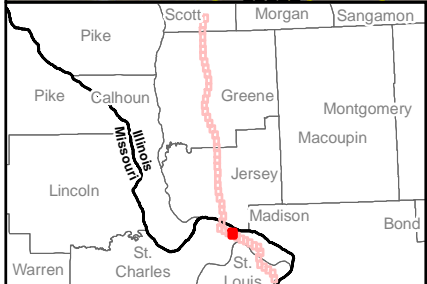

REFERENCE: ESRI WORLD IMAGERY AND TRANSPORTATION, NIP, USDA FSA, 2014. ACCESSED 04/2017. SOIL SURVEY GEOGRAPHIC (SSURGO) DATABASE FOR ILLINOIS (2014) AND MISSOURI (2015), USDA/NRCS.

**LEGEND**

- FACILITY
- MILEPOST
- 24-INCH PIPELINE
- NORTH COUNTY EXTENSION
- ACCESS ROAD
- SOIL TYPE BOUNDARY
- PERMANENT LIMIT OF DISTURBANCE
- TEMPORARY LIMIT OF DISTURBANCE
- TEMPORARY AND PERMANENT LIMIT OF DISTURBANCE
- COUNTY BOUNDARY
- STATE BOUNDARY

0 250 500 1,000 Feet

**SOILS MAP  
SHEET 38 OF 51**

**SPIRE STL  
PIPELINE  
PROJECT**

DRAWN BY: PMH      DATE: 4/6/2017  
 CHECKED: EFJ      APPROVED: LMF

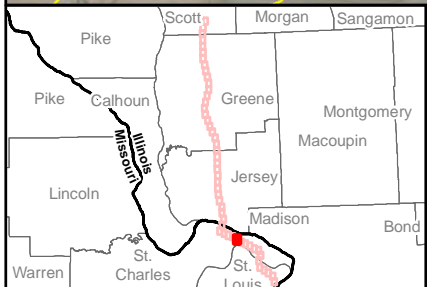
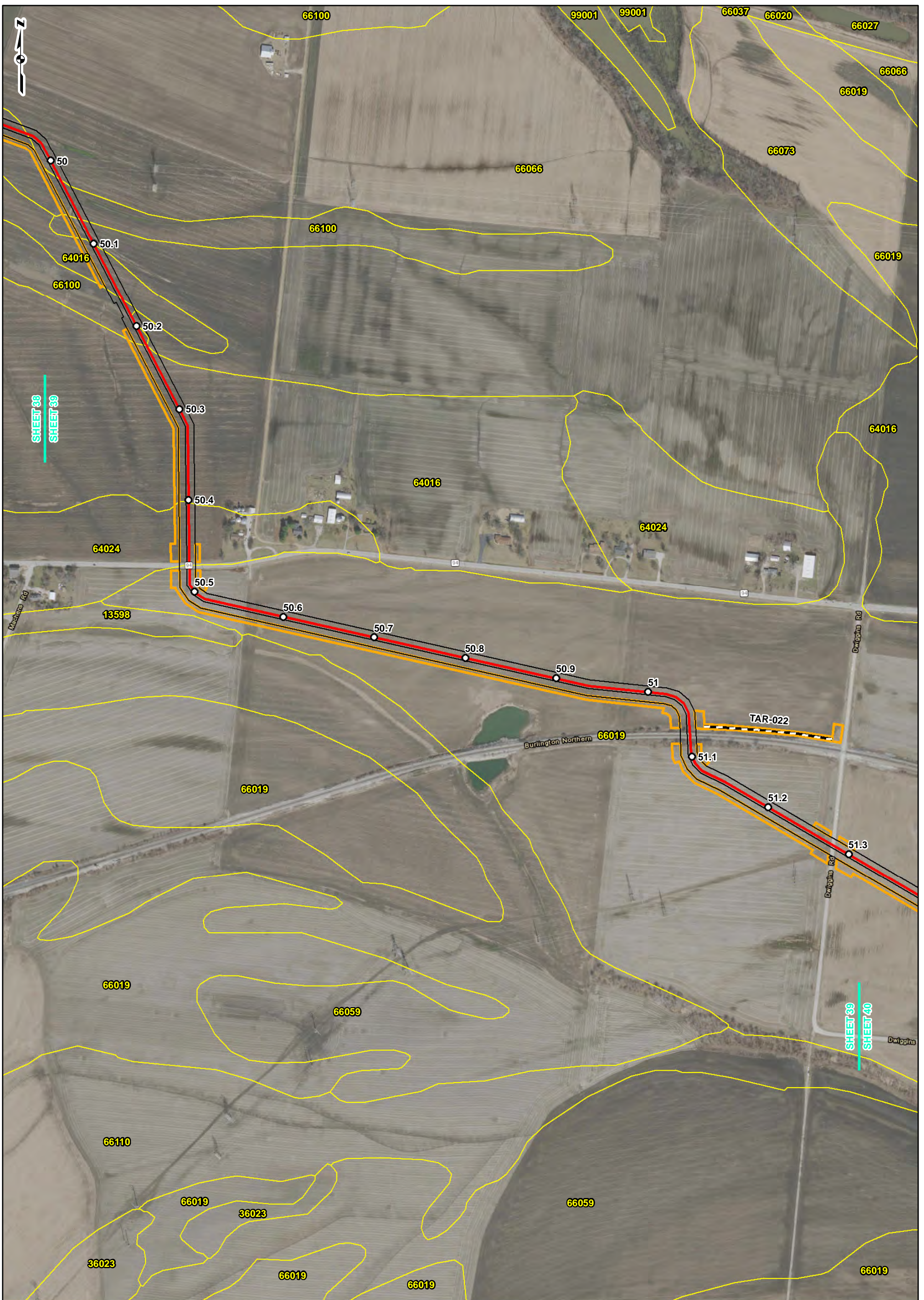

REFERENCE: ESRI WORLD IMAGERY AND TRANSPORTATION, NAIP, USDA FSA, 2014, ACCESSED 04/2017, SOIL SURVEY GEOGRAPHIC (SSURGO) DATABASE FOR ILLINOIS (2014) AND MISSOURI (2015), USDA/NRCS.

**LEGEND**

- FACILITY
- MILEPOST
- 24-INCH PIPELINE
- NORTH COUNTY EXTENSION
- ACCESS ROAD
- SOIL TYPE BOUNDARY
- PERMANENT LIMIT OF DISTURBANCE
- TEMPORARY LIMIT OF DISTURBANCE
- TEMPORARY AND PERMANENT LIMIT OF DISTURBANCE
- COUNTY BOUNDARY
- STATE BOUNDARY

0      250      500      1,000  
Feet

**SOILS MAP  
SHEET 39 OF 51**

**SPIRE STL  
PIPELINE  
PROJECT**

DRAWN BY: PMH      DATE: 4/6/2017  
CHECKED: EFJ      APPROVED: LMF

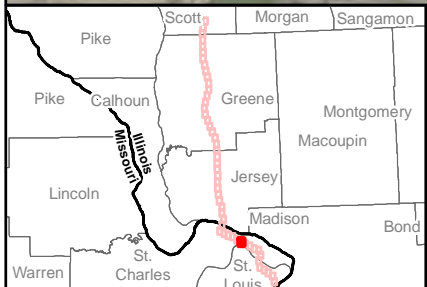

REFERENCE: ESRI WORLD IMAGERY AND TRANSPORTATION, NAIP, USDA FSA, 2014, ACCESSED 04/2017, SOIL SURVEY GEOGRAPHIC (SSURGO) DATABASE FOR ILLINOIS (2014) AND MISSOURI (2015), USDA/NRCS.

**LEGEND**

- FACILITY
- MILEPOST
- 24-INCH PIPELINE
- NORTH COUNTY EXTENSION
- ACCESS ROAD
- SOIL TYPE BOUNDARY
- PERMANENT LIMIT OF DISTURBANCE
- TEMPORARY LIMIT OF DISTURBANCE
- TEMPORARY AND PERMANENT LIMIT OF DISTURBANCE
- COUNTY BOUNDARY
- STATE BOUNDARY

0 250 500 1,000 Feet

**SOILS MAP  
SHEET 40 OF 51**

**SPiRE STL  
PIPELINE  
PROJECT**

DRAWN BY: PMH      DATE: 4/6/2017  
CHECKED: EFJ      APPROVED: LMF

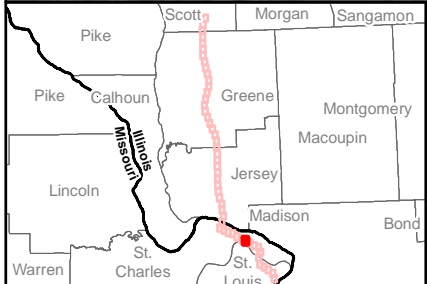

REFERENCE: ESRI WORLD IMAGERY AND TRANSPORTATION, NAIP, USDA FSA, 2014, ACCESSED 04/2017. SOIL SURVEY GEOGRAPHIC (SSURGO) DATABASE FOR ILLINOIS (2014) AND MISSOURI (2015), USDA/NRCS.

**LEGEND**

- FACILITY
- MILEPOST
- 24-INCH PIPELINE
- NORTH COUNTY EXTENSION
- ACCESS ROAD
- SOIL TYPE BOUNDARY
- PERMANENT LIMIT OF DISTURBANCE
- TEMPORARY LIMIT OF DISTURBANCE
- TEMPORARY AND PERMANENT LIMIT OF DISTURBANCE
- COUNTY BOUNDARY
- STATE BOUNDARY

0      250      500      1,000  
Feet

**SOILS MAP  
SHEET 41 OF 51**

**SPIRE STL  
PIPELINE  
PROJECT**

DRAWN BY: PMH      DATE: 4/6/2017  
CHECKED: EFJ      APPROVED: LMF

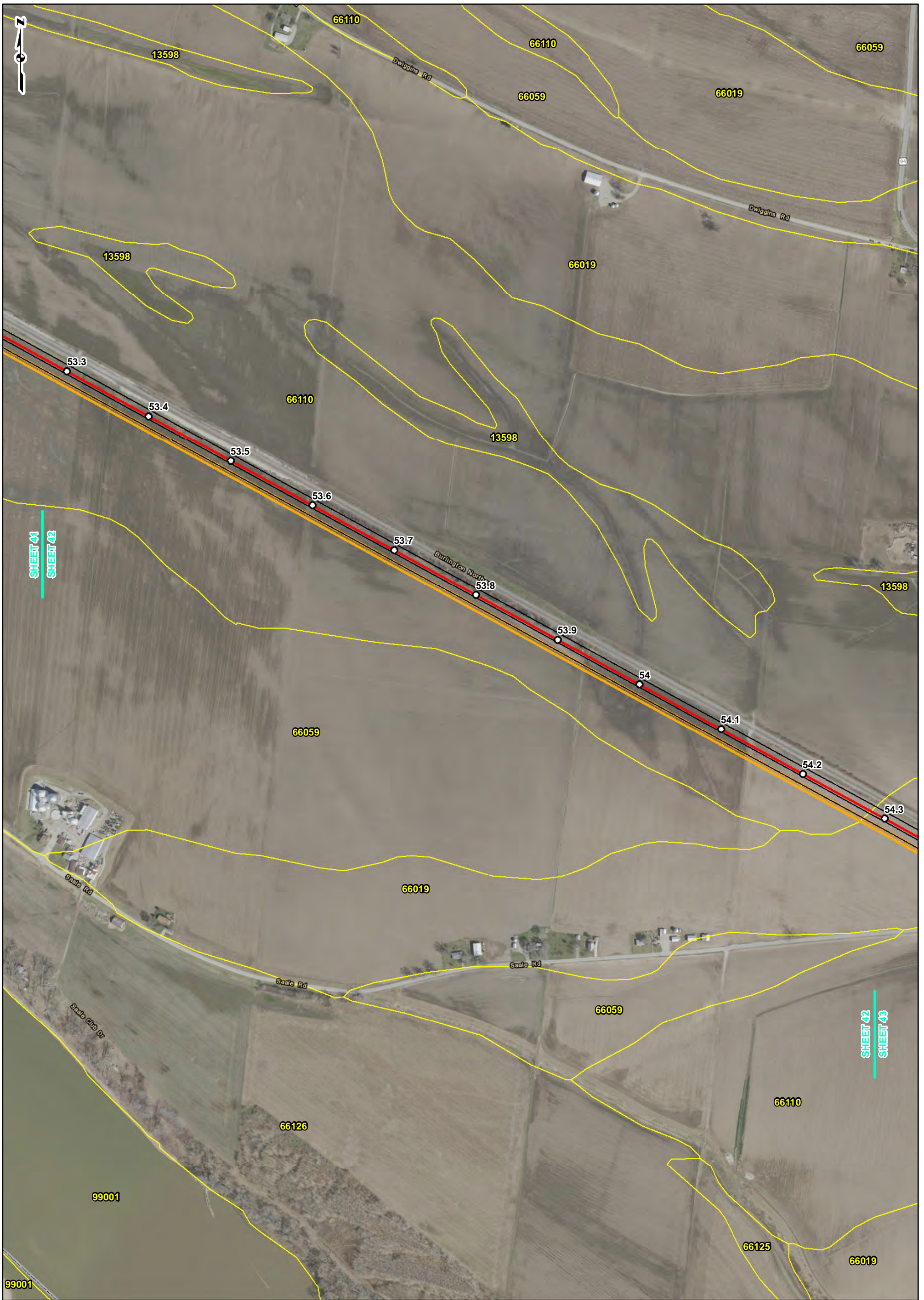

SHEET 41  
SHEET 42

SHEET 42  
SHEET 43

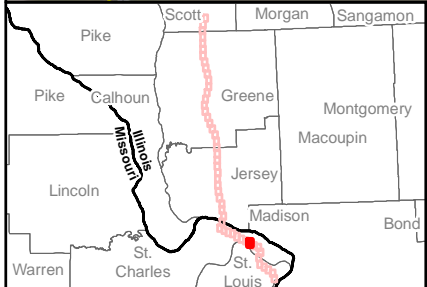

REFERENCE: ESRI WORLD IMAGERY AND TRANSPORTATION, NAIP, USDA FSA, 2014, ACCESSED 04/2017, SOIL SURVEY GEOGRAPHIC (SSURGO) DATABASE FOR ILLINOIS (2014) AND MISSOURI (2015), USDA/NRCS.

**LEGEND**

- FACILITY
- MILEPOST
- 24-INCH PIPELINE
- NORTH COUNTY EXTENSION
- ACCESS ROAD
- SOIL TYPE BOUNDARY
- PERMANENT LIMIT OF DISTURBANCE
- TEMPORARY LIMIT OF DISTURBANCE
- TEMPORARY AND PERMANENT LIMIT OF DISTURBANCE
- COUNTY BOUNDARY
- STATE BOUNDARY

0      250      500      1,000  
Feet

**SOILS MAP  
SHEET 42 OF 51**

**SPIRE STL  
PIPELINE  
PROJECT**

DRAWN BY: PMH      DATE: 4/6/2017  
CHECKED: EFJ      APPROVED: LMF





SHEET 42  
SHEET 43

SHEET 43  
SHEET 44

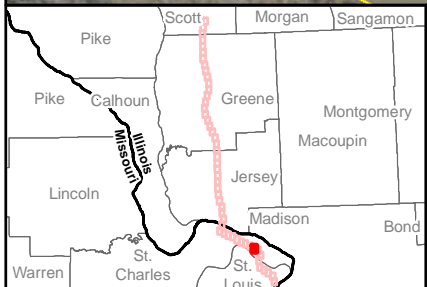



REFERENCE: ESRI WORLD IMAGERY AND TRANSPORTATION, NAIP, USDA FSA, 2014, ACCESSED 04/2017, SOIL SURVEY GEOGRAPHIC (SSURGO) DATABASE FOR ILLINOIS (2014) AND MISSOURI (2015), USDA/NRCS.

**LEGEND**

- FACILITY
- MILEPOST
- 24-INCH PIPELINE
- NORTH COUNTY EXTENSION
- ACCESS ROAD
- SOIL TYPE BOUNDARY
- PERMANENT LIMIT OF DISTURBANCE
- TEMPORARY LIMIT OF DISTURBANCE
- TEMPORARY AND PERMANENT LIMIT OF DISTURBANCE
- COUNTY BOUNDARY
- STATE BOUNDARY

0 250 500 1,000 Feet

**SOILS MAP  
SHEET 43 OF 51**

**SPIRE STL  
PIPELINE  
PROJECT**

DRAWN BY: PMH      DATE: 4/6/2017  
CHECKED: EFJ      APPROVED: LMF



SHEET 43  
SHEET 44

SHEET 44  
SHEET 45

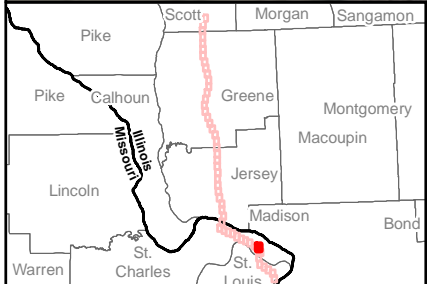

REFERENCE: ESRI WORLD IMAGERY AND TRANSPORTATION, NAIP, USDA FSA, 2014, ACCESSED 04/2017, SOIL SURVEY GEOGRAPHIC (SSURGO) DATABASE FOR ILLINOIS (2014) AND MISSOURI (2015), USDA/NRCS.

**LEGEND**

- FACILITY
- MILEPOST
- 24-INCH PIPELINE
- NORTH COUNTY EXTENSION
- ACCESS ROAD
- SOIL TYPE BOUNDARY
- PERMANENT LIMIT OF DISTURBANCE
- TEMPORARY LIMIT OF DISTURBANCE
- LIMIT OF DISTURBANCE
- COUNTY BOUNDARY
- STATE BOUNDARY

0      250      500      1,000  
Feet

**SOILS MAP  
SHEET 44 OF 51**

**SPIRE STL  
PIPELINE  
PROJECT**

DRAWN BY: PMH      DATE: 4/6/2017  
CHECKED: EFJ      APPROVED: LMF



SHEET 44  
SHEET 45

SHEET 45  
SHEET 46

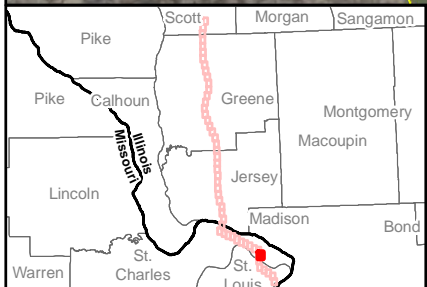

REFERENCE: ESRI WORLD IMAGERY AND TRANSPORTATION, NAIP, USDA FSA, 2014, ACCESSED 04/2017, SOIL SURVEY GEOGRAPHIC (SSURGO) DATABASE FOR ILLINOIS (2014) AND MISSOURI (2015), USDA/NRCS.

**LEGEND**

- FACILITY
- MILEPOST
- 24-INCH PIPELINE
- NORTH COUNTY EXTENSION
- ACCESS ROAD
- SOIL TYPE BOUNDARY
- PERMANENT LIMIT OF DISTURBANCE
- TEMPORARY LIMIT OF DISTURBANCE
- TEMPORARY AND PERMANENT LIMIT OF DISTURBANCE
- COUNTY BOUNDARY
- STATE BOUNDARY

0      250      500      1,000  
Feet

**SOILS MAP  
SHEET 45 OF 51**

**SPIRE STL  
PIPELINE  
PROJECT**

DRAWN BY: PMH      DATE: 4/6/2017  
CHECKED: EFJ      APPROVED: LMF

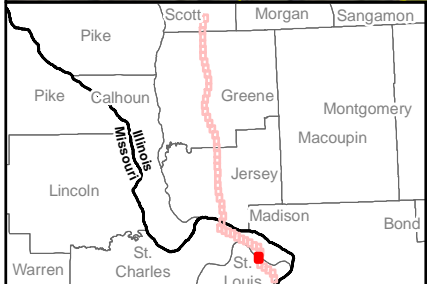

REFERENCE: ESRI WORLD IMAGERY AND TRANSPORTATION, NAIP, USDA FSA, 2014, ACCESSED 04/2017, SOIL SURVEY GEOGRAPHIC (SSURGO) DATABASE FOR ILLINOIS (2014) AND MISSOURI (2015), USDA/NRCS.

**LEGEND**

- FACILITY
- MILEPOST
- 24-INCH PIPELINE
- NORTH COUNTY EXTENSION
- ACCESS ROAD
- SOIL TYPE BOUNDARY
- PERMANENT LIMIT OF DISTURBANCE
- TEMPORARY LIMIT OF DISTURBANCE
- LIMIT OF DISTURBANCE
- COUNTY BOUNDARY
- STATE BOUNDARY

0 250 500 1,000 Feet

**SOILS MAP  
SHEET 46 OF 51**

**SPIRE STL  
PIPELINE  
PROJECT**

gal consultants spire

DRAWN BY: PMH      DATE: 4/6/2017  
 CHECKED: EFJ      APPROVED: LMF

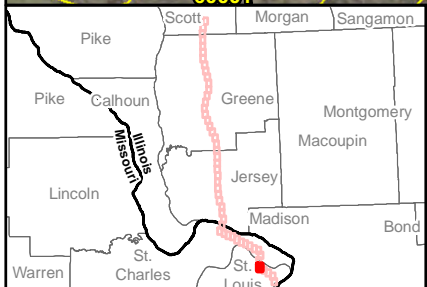

REFERENCE: ESRI WORLD IMAGERY AND TRANSPORTATION; NAIP, USDA FSA, 2014. ACCESSED 04/2017. SOIL SURVEY GEOGRAPHIC (SSURGO) DATABASE FOR ILLINOIS (2014) AND MISSOURI (2015), USDA/NRCS.

**LEGEND**

- FACILITY
- MILEPOST
- 24-INCH PIPELINE
- NORTH COUNTY EXTENSION
- ACCESS ROAD
- SOIL TYPE BOUNDARY
- PERMANENT LIMIT OF DISTURBANCE
- TEMPORARY LIMIT OF DISTURBANCE
- TEMPORARY AND PERMANENT LIMIT OF DISTURBANCE
- COUNTY BOUNDARY
- STATE BOUNDARY

0      250      500      1,000  
Feet

**SOILS MAP  
SHEET 47 OF 51**

**SPIRE STL  
PIPELINE  
PROJECT**

DRAWN BY: PMH      DATE: 4/6/2017  
CHECKED: EFJ      APPROVED: LMF



REFERENCE: ESRI WORLD IMAGERY AND TRANSPORTATION, NIP, USDA FSA, 2014. ACCESSED 04/2017. SOIL SURVEY GEOGRAPHIC (SSURGO) DATABASE FOR ILLINOIS (2014) AND MISSOURI (2015), USDA/NRCS.

**LEGEND**

- FACILITY
- MILEPOST
- 24-INCH PIPELINE
- NORTH COUNTY EXTENSION
- ACCESS ROAD
- SOIL TYPE BOUNDARY
- PERMANENT LIMIT OF DISTURBANCE
- TEMPORARY LIMIT OF DISTURBANCE
- TEMPORARY AND PERMANENT LIMIT OF DISTURBANCE
- COUNTY BOUNDARY
- STATE BOUNDARY

0 250 500 1,000 Feet

**SOILS MAP  
SHEET 48 OF 51**

**SPIRE STL  
PIPELINE  
PROJECT**

DRAWN BY: PMH      DATE: 4/6/2017  
 CHECKED: EFJ      APPROVED: LMF

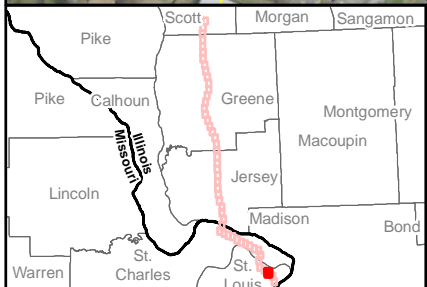

REFERENCE: ESRI WORLD IMAGERY AND TRANSPORTATION, NAIP, USDA FSA, 2014. ACCESSED 04/2017. SOIL SURVEY GEOGRAPHIC (SSURGO) DATABASE FOR ILLINOIS (2014) AND MISSOURI (2015), USDA/NRCS.

LEGEND	
	FACILITY
	MILEPOST
	24-INCH PIPELINE
	NORTH COUNTY EXTENSION
	ACCESS ROAD
	SOIL TYPE BOUNDARY
	PERMANENT LIMIT OF DISTURBANCE
	TEMPORARY LIMIT OF DISTURBANCE
	TEMPORARY AND PERMANENT LIMIT OF DISTURBANCE
	COUNTY BOUNDARY
	STATE BOUNDARY

0 250 500 1,000 Feet

<b>SOILS MAP SHEET 49 OF 51</b>	
	<b>SPIRE STL PIPELINE PROJECT</b>
DRAWN BY: PMH CHECKED: EFJ	DATE: 4/6/2017 APPROVED: LMF

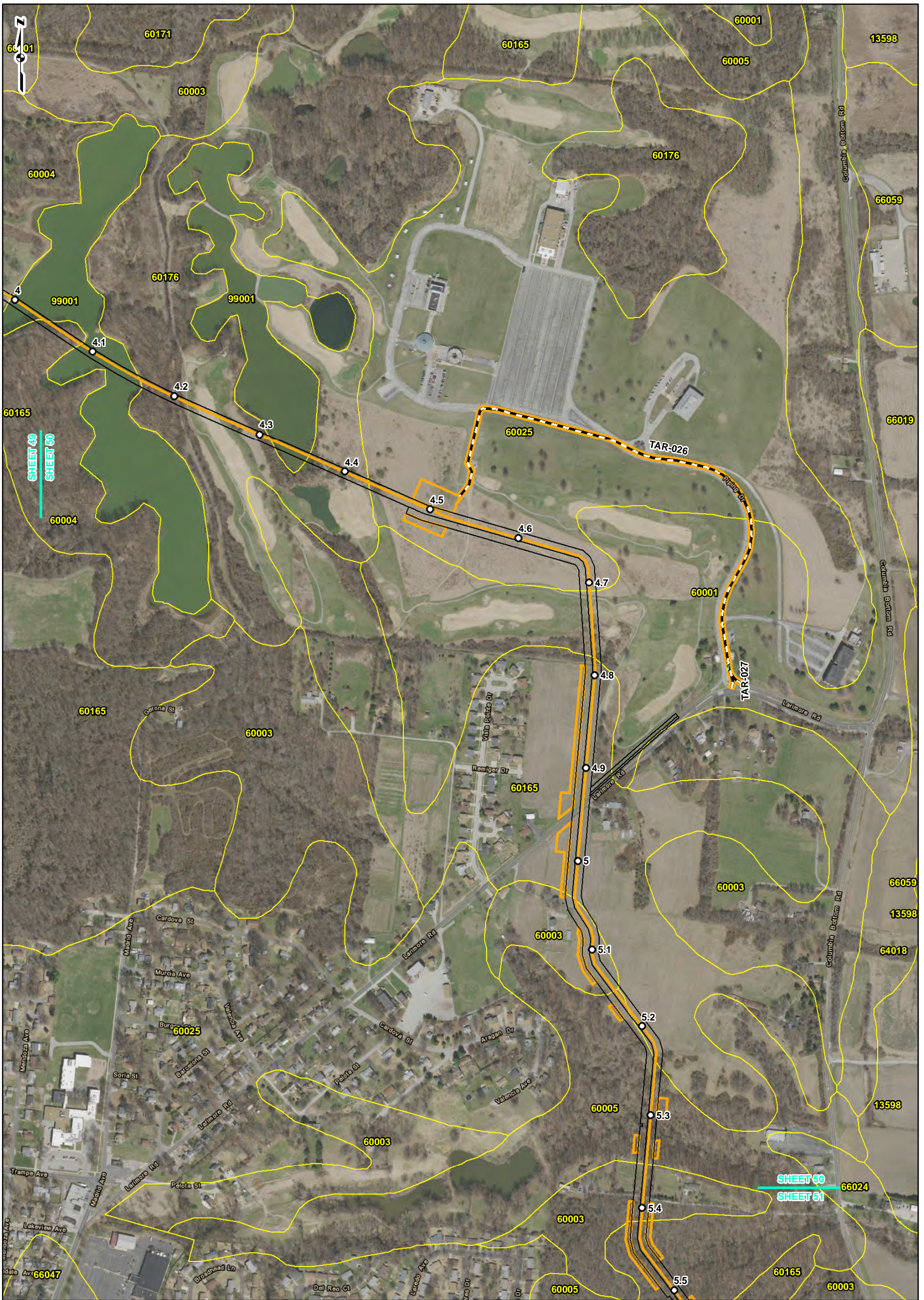

REFERENCE: ESRI WORLD IMAGERY AND TRANSPORTATION, NAIP, USDA FSA, 2014. ACCESSED 04/2017. SOIL SURVEY GEOGRAPHIC (SSURGO) DATABASE FOR ILLINOIS (2014) AND MISSOURI (2015), USDA/NRCS.

**LEGEND**

- FACILITY
- MILEPOST
- 24-INCH PIPELINE
- NORTH COUNTY EXTENSION
- ACCESS ROAD
- SOIL TYPE BOUNDARY
- PERMANENT LIMIT OF DISTURBANCE
- TEMPORARY LIMIT OF DISTURBANCE
- TEMPORARY AND PERMANENT LIMIT OF DISTURBANCE
- COUNTY BOUNDARY
- STATE BOUNDARY

0      250      500      1,000  
Feet

**SOILS MAP  
SHEET 50 OF 51**

**SPIRE STL  
PIPELINE  
PROJECT**

DRAWN BY: PMH      DATE: 4/6/2017  
 CHECKED: EFJ      APPROVED: LMF



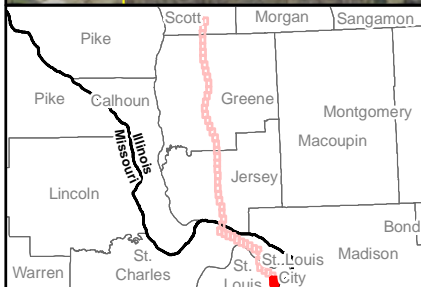
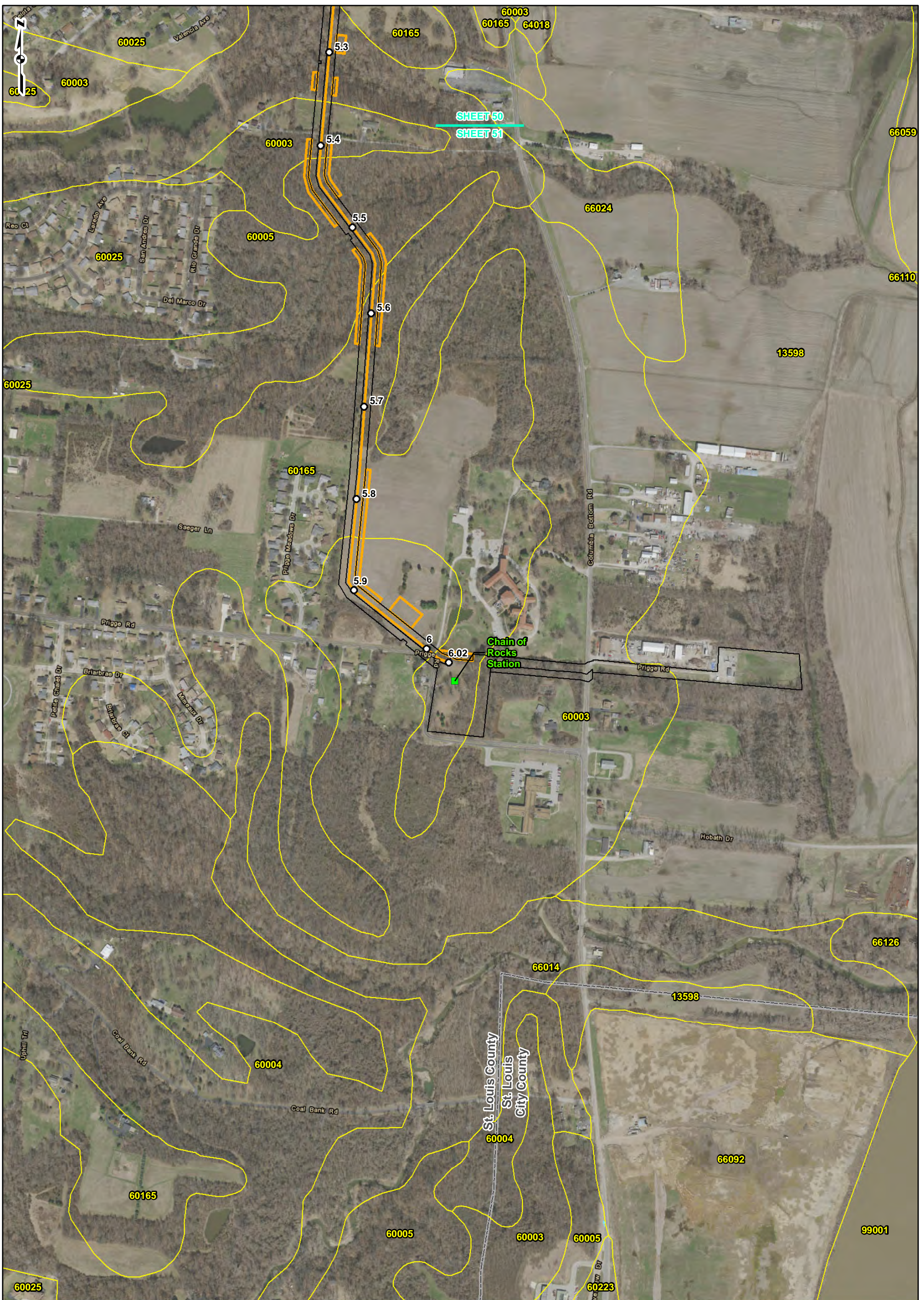



REFERENCE: ESRI WORLD IMAGERY AND TRANSPORTATION; NAIP; USDA FSA, 2014. ACCESSED 04/2017. SOIL SURVEY GEOGRAPHIC (SSURGO) DATABASE FOR ILLINOIS (2014) AND MISSOURI (2015), USDA/NRCS.

**LEGEND**

FACILITY	PERMANENT LIMIT OF DISTURBANCE
MILEPOST	TEMPORARY LIMIT OF DISTURBANCE
24-INCH PIPELINE	TEMPORARY AND PERMANENT LIMIT OF DISTURBANCE
NORTH COUNTY EXTENSION	COUNTY BOUNDARY
ACCESS ROAD	STATE BOUNDARY
SOIL TYPE BOUNDARY	

0 250 500 1,000 Feet

**SOILS MAP  
SHEET 51 OF 51**

**SPIRE STL  
PIPELINE  
PROJECT**

DRAWN BY: PMH      DATE: 4/6/2017  
 CHECKED: EFJ      APPROVED: LMF



## **APPENDIX 7-B**

### **Soil Characteristics by Milepost and Soil Descriptions**



**Appendix 7-B. Soil Characteristics by MP Segment for Each Soil Map Unit along the Proposed Project**

Nearest MP	Map Unit Symbol	Component Name	Component Percent	Crossing Length (miles)	Prime Farmland (Y/N) <sup>1</sup>	Hydric Soils (Y/N) <sup>1</sup>	Compaction Prone (Y/N) <sup>2</sup>	Highly Erodible		Revegetation Concerns (Y/N) <sup>5</sup>	Stony/Rocky (Y/N) <sup>6</sup>	Shallow to Bedrock (Y/N) <sup>7</sup>
								Water (Y/N) <sup>3</sup>	Wind (Y/N) <sup>4</sup>			
<b>24-Inch Pipeline</b>												
<i>Scott County, Illinois</i>												
0.0R	279C3	Rozetta	94	0.14	N	N	N	Y	N	Y	N	N
0.2R	279B	Rozetta	90	0.06	Y	N	N	N	N	N	N	N
0.3R	257A	Clarksdale	90	0.12	N	N	N	N	N	N	N	N
0.4R	43A	Ipava	85	0.13	Y	N	N	N	N	N	N	N
0.5R	50A	Virден	90	0.25	N	Y	N	N	N	N	N	N
0.7	43A	Ipava	85	0.09	Y	N	N	N	N	N	N	N
0.7	50A	Virден	90	0.02	N	Y	N	N	N	N	N	N
0.8	43A	Ipava	85	0.11	Y	N	N	N	N	N	N	N
0.9	257A	Clarksdale	90	0.10	N	N	N	N	N	N	N	N
1.0	279B	Rozetta	90	0.18	Y	N	N	N	N	N	N	N
1.1	279C3	Rozetta	94	0.02	N	N	N	Y	N	Y	N	N
1.1	279B	Rozetta	90	0.02	Y	N	N	N	N	N	N	N
1.2	279C3	Rozetta	94	0.03	N	N	N	Y	N	Y	N	N
1.2	279B	Rozetta	90	0.03	Y	N	N	N	N	N	N	N
1.2	279C3	Rozetta	94	0.06	N	N	N	Y	N	Y	N	N
1.3	17A	Keomah	90	0.04	N	N	N	N	N	N	N	N
1.3	279B	Rozetta	90	0.02	Y	N	N	N	N	N	N	N
1.4	279C3	Rozetta	94	0.04	N	N	N	Y	N	Y	N	N
1.4	279B	Rozetta	90	0.03	Y	N	N	N	N	N	N	N
1.4	17A	Keomah	90	0.02	N	N	N	N	N	N	N	N
1.5R	279B	Rozetta	90	0.07	Y	N	N	N	N	N	N	N
1.6R	43A	Ipava	85	0.22	Y	N	N	N	N	N	N	N
1.8R	17A	Keomah	90	0.07	N	N	N	N	N	N	N	N
1.8R	279B	Rozetta	90	0.12	Y	N	N	N	N	N	N	N
1.9R	279C3	Rozetta	94	0.06	N	N	N	Y	N	Y	N	N
2.0R	279B	Rozetta	90	0.02	Y	N	N	N	N	N	N	N
2.0R	17A	Keomah	90	0.21	N	N	N	N	N	N	N	N
2.1	119D3	Elco	94	0.14	N	N	N	Y	N	Y	N	N



**Appendix 7-B. Soil Characteristics by MP Segment for Each Soil Map Unit along the Proposed Project (Continued)**

Nearest MP	Map Unit Symbol	Component Name	Component Percent	Crossing Length (miles)	Prime Farmland (Y/N) <sup>1</sup>	Hydric Soils (Y/N) <sup>2</sup>	Compaction Prone (Y/N) <sup>2</sup>	Highly Erodible		Revegetation Concerns (Y/N) <sup>5</sup>	Stony/Rocky (Y/N) <sup>6</sup>	Shallow to Bedrock (Y/N) <sup>7</sup>
								Water (Y/N) <sup>3</sup>	Wind (Y/N) <sup>4</sup>			
<b>24-Inch Pipeline (Continued)</b>												
<i>Scott County, Illinois</i>												
2.2	17A	Keomah	90	0.10	N	N	N	N	N	N	N	N
2.3	19C3	Slyvan	100	0.06	N	N	N	Y	N	N	N	N
2.4	17A	Keomah	90	0.09	N	N	N	N	N	N	N	N
2.5	915D2	Elco, Ursa	90	0.01	N	N	N	Y	N	N	N	N
2.5	17A	Keomah	90	0.03	N	N	N	N	N	N	N	N
2.5	279B	Rozetta	90	0.06	Y	N	N	N	N	N	N	N
2.6	280D3	Fayette	95	0.03	N	N	N	Y	N	Y	N	N
2.6	8E2	Hickory	90	0.05	N	N	N	Y	N	N	N	N
2.6	3078A	Arenzville	95	0.05	N	N	N	N	N	N	N	N
2.7	8F	Hickory	89	0.10	N	N	N	Y	N	Y	N	N
2.8	280D2	Fayette	95	0.09	N	N	N	N	N	Y	N	N
2.9	279B	Rozetta	90	0.11	Y	N	N	N	N	N	N	N
3.0	17A	Keomah	90	0.03	N	N	N	N	N	N	N	N
3.0	119D3	Elco	94	0.04	N	N	N	Y	N	Y	N	N
3.2	279B	Rozetta	90	0.18	Y	N	N	N	N	N	N	N
3.3	280C2	Fayette	95	0.10	N	N	N	N	N	Y	N	N
3.3	8E2	Hickory	90	0.04	N	N	N	Y	N	N	N	N
3.4	3333A	Wakeland	90	0.07	N	N	N	N	N	N	N	N
3.5	8F	Hickory	89	0.11	N	N	N	Y	N	Y	N	N
<i>Greene County, Illinois</i>												
3.6	8F	Hickory	89	0.06	N	N	N	Y	N	Y	N	N
3.6	279D2	Rozetta	94	0.01	N	N	N	N	N	Y	N	N
3.6	279B	Rozetta	90	0.03	Y	N	N	N	N	N	N	N
3.7	279D2	Rozetta	94	0.02	N	N	N	N	N	Y	N	N
3.7	279B	Rozetta	90	0.06	Y	N	N	N	N	N	N	N
3.7	279D2	Rozetta	94	0.04	N	N	N	N	N	Y	N	N
3.8	8F	Hickory	89	0.04	N	N	N	Y	N	Y	N	N
3.8	279D2	Rozetta	94	0.00	N	N	N	N	N	Y	N	N



**Appendix 7-B. Soil Characteristics by MP Segment for Each Soil Map Unit along the Proposed Project (Continued)**

Nearest MP	Map Unit Symbol	Component Name	Component Percent	Crossing Length (miles)	Prime Farmland (Y/N) <sup>1</sup>	Hydric Soils (Y/N) <sup>2</sup>	Compaction Prone (Y/N) <sup>2</sup>	Highly Erodible		Revegetation Concerns (Y/N) <sup>5</sup>	Stony/Rocky (Y/N) <sup>6</sup>	Shallow to Bedrock (Y/N) <sup>7</sup>
								Water (Y/N) <sup>3</sup>	Wind (Y/N) <sup>4</sup>			
<b>24-Inch Pipeline (Continued)</b>												
<i>Greene County, Illinois (Continued)</i>												
3.8	279B	Rozetta	90	0.04	Y	N	N	N	N	N	N	N
3.9	8F2	Hickory	90	0.07	N	N	N	Y	N	Y	N	N
3.9	242A	Kendall	90	0.02	N	N	N	N	N	N	N	N
4.0	3451A	Lawson	90	0.05	N	N	N	N	N	N	N	N
4.0	8F	Hickory	89	0.04	N	N	N	Y	N	Y	N	N
4.1	280B	Fayette	97	0.09	Y	N	N	N	N	N	N	N
4.2	279B	Rozetta	90	0.07	Y	N	N	N	N	N	N	N
4.2	279D2	Rozetta	94	0.05	N	N	N	N	N	Y	N	N
4.3	8F	Hickory	89	0.07	N	N	N	Y	N	Y	N	N
4.3	279D2	Rozetta	94	0.03	N	N	N	N	N	Y	N	N
4.4	279B	Rozetta	90	0.14	Y	N	N	N	N	N	N	N
4.5	279D2	Rozetta	94	0.03	N	N	N	N	N	Y	N	N
4.6	279B	Rozetta	90	0.10	Y	N	N	N	N	N	N	N
4.7	51A	Muscatune	90	0.14	Y	N	N	N	N	N	N	N
4.8	68A	Sable	85	0.06	N	N	N	N	N	N	N	N
4.9	51A	Muscatune	90	0.09	Y	N	N	N	N	N	N	N
4.9	675B	Greenbush	90	0.02	Y	N	N	N	N	N	N	N
4.9	675C2	Greenbush	95	0.02	N	N	N	N	N	Y	N	N
5.0	675B	Greenbush	90	0.04	Y	N	N	N	N	N	N	N
5.0	675C2	Greenbush	95	0.03	N	N	N	N	N	Y	N	N
5.0	3451A	Lawson	90	0.02	N	N	N	N	N	N	N	N
5.0	675C2	Greenbush	95	0.03	N	N	N	N	N	Y	N	N
5.1	61A	Atterberry	98	0.03	N	N	N	N	N	N	N	N
5.1	675C2	Greenbush	95	0.05	N	N	N	N	N	Y	N	N
5.2	279B	Rozetta	90	0.03	Y	N	N	N	N	N	N	N
5.3	61A	Atterberry	98	0.15	N	N	N	N	N	N	N	N
5.4	51A	Muscatune	90	0.16	Y	N	N	N	N	N	N	N
5.5	675C2	Greenbush	95	0.07	N	N	N	N	N	Y	N	N



**Appendix 7-B. Soil Characteristics by MP Segment for Each Soil Map Unit along the Proposed Project (Continued)**

Nearest MP	Map Unit Symbol	Component Name	Component Percent	Crossing Length (miles)	Prime Farmland (Y/N) <sup>1</sup>	Hydric Soils (Y/N) <sup>1</sup>	Compaction Prone (Y/N) <sup>2</sup>	Highly Erodible		Revegetation Concerns (Y/N) <sup>5</sup>	Stony/Rocky (Y/N) <sup>6</sup>	Shallow to Bedrock (Y/N) <sup>7</sup>
								Water (Y/N) <sup>3</sup>	Wind (Y/N) <sup>4</sup>			
<b>24-Inch Pipeline (Continued)</b>												
<i>Greene County, Illinois (Continued)</i>												
5.6	675B	Greenbush	90	0.03	Y	N	N	N	N	N	N	N
5.6	279D2	Rozetta	94	0.10	N	N	N	N	N	Y	N	N
5.7	279B	Rozetta	90	0.02	Y	N	N	N	N	N	N	N
5.7	279D2	Rozetta	94	0.10	N	N	N	N	N	Y	N	N
5.8	257B	Clarksdale	90	0.02	Y	N	N	N	N	N	N	N
5.8	279D2	Rozetta	94	0.00	N	N	N	N	N	Y	N	N
6.0	61A	Atterberry	98	0.25	N	N	N	N	N	N	N	N
6.1	675B	Greenbush	90	0.01	Y	N	N	N	N	N	N	N
6.1	61A	Atterberry	98	0.05	N	N	N	N	N	N	N	N
6.1	675C2	Greenbush	95	0.01	N	N	N	N	N	Y	N	N
6.1	279D2	Rozetta	94	0.01	N	N	N	N	N	Y	N	N
6.2	279B	Rozetta	90	0.04	Y	N	N	N	N	N	N	N
6.2	279D2	Rozetta	94	0.06	N	N	N	N	N	Y	N	N
6.3	8D2	Hickory	90	0.12	N	N	N	N	N	Y	N	N
6.4	3451A	Lawson	90	0.11	N	N	N	N	N	N	N	N
6.5	8F2	Hickory	90	0.06	N	N	N	Y	N	Y	N	N
6.6	279B	Rozetta	90	0.33	Y	N	N	N	N	N	N	N
6.9	61A	Atterberry	98	0.07	N	N	N	N	N	N	N	N
6.9	279C2	Rozetta	94	0.01	N	N	N	N	N	Y	N	N
7.0	61A	Atterberry	98	0.08	N	N	N	N	N	N	N	N
7.3	68A	Sable	85	0.39	N	N	N	N	N	N	N	N
7.5	47A	Viriden	90	0.10	N	Y	N	N	N	N	N	N
7.5	51A	Muscatune	90	0.05	Y	N	N	N	N	N	N	N
7.6	47A	Viriden	90	0.14	N	Y	N	N	N	N	N	N
7.8	51A	Muscatune	90	0.12	Y	N	N	N	N	N	N	N
7.9	47A	Viriden	90	0.10	N	Y	N	N	N	N	N	N
8.0	51A	Muscatune	90	0.09	Y	N	N	N	N	N	N	N
8.0	675B	Greenbush	90	0.09	Y	N	N	N	N	N	N	N



**Appendix 7-B. Soil Characteristics by MP Segment for Each Soil Map Unit along the Proposed Project (Continued)**

Nearest MP	Map Unit Symbol	Component Name	Component Percent	Crossing Length (miles)	Prime Farmland (Y/N) <sup>1</sup>	Hydric Soils (Y/N) <sup>1</sup>	Compaction Prone (Y/N) <sup>2</sup>	Highly Erodible		Revegetation Concerns (Y/N) <sup>5</sup>	Stony/Rocky (Y/N) <sup>6</sup>	Shallow to Bedrock (Y/N) <sup>7</sup>
								Water (Y/N) <sup>3</sup>	Wind (Y/N) <sup>4</sup>			
<b>24-Inch Pipeline (Continued)</b>												
<i>Greene County, Illinois (Continued)</i>												
8.1	279B	Rozetta	90	0.10	Y	N	N	N	N	N	N	N
8.2	675B	Greenbush	90	0.16	Y	N	N	N	N	N	N	N
8.4	51A	Muscatune	90	0.08	Y	N	N	N	N	N	N	N
8.5	675B	Greenbush	90	0.10	Y	N	N	N	N	N	N	N
8.6	279B	Rozetta	90	0.14	Y	N	N	N	N	N	N	N
8.7	675B	Greenbush	90	0.02	Y	N	N	N	N	N	N	N
8.7	279C2	Rozetta	94	0.03	N	N	N	N	N	Y	N	N
8.7	675B	Greenbush	90	0.03	Y	N	N	N	N	N	N	N
8.8	279C2	Rozetta	94	0.03	N	N	N	N	N	Y	N	N
8.8	279D2	Rozetta	94	0.02	N	N	N	N	N	Y	N	N
8.8	279C2	Rozetta	94	0.01	N	N	N	N	N	Y	N	N
8.8	279D2	Rozetta	94	0.04	N	N	N	N	N	Y	N	N
8.9	279B	Rozetta	90	0.02	Y	N	N	N	N	N	N	N
8.9	17A	Keomah	90	0.05	N	N	N	N	N	N	N	N
9.0	279C2	Rozetta	94	0.04	N	N	N	N	N	Y	N	N
9.0	51A	Muscatune	90	0.09	Y	N	N	N	N	N	N	N
9.1	47A	Virden	90	0.04	N	Y	N	N	N	N	N	N
9.2	51A	Muscatune	90	0.10	Y	N	N	N	N	N	N	N
9.2	47A	Virden	90	0.06	N	Y	N	N	N	N	N	N
9.3	51A	Muscatune	90	0.02	Y	N	N	N	N	N	N	N
9.3	68A	Sable	85	0.15	N	N	N	N	N	N	N	N
9.5	51A	Muscatune	90	0.15	Y	N	N	N	N	N	N	N
9.6	51B	Muscatune	95	0.21	Y	N	N	N	N	N	N	N
9.8	86C2	Oscos	90	0.07	N	N	N	N	N	Y	N	N
9.9	675C2	Greenbush	95	0.01	N	N	N	N	N	Y	N	N
9.9	86C2	Oscos	90	0.04	N	N	N	N	N	Y	N	N
9.9	675C2	Greenbush	95	0.04	N	N	N	N	N	Y	N	N
10.0	86B	Oscos	90	0.05	Y	N	N	N	N	N	N	N



**Appendix 7-B. Soil Characteristics by MP Segment for Each Soil Map Unit along the Proposed Project (Continued)**

Nearest MP	Map Unit Symbol	Component Name	Component Percent	Crossing Length (miles)	Prime Farmland (Y/N) <sup>1</sup>	Hydric Soils (Y/N) <sup>2</sup>	Compaction Prone (Y/N) <sup>2</sup>	Highly Erodible		Revegetation Concerns (Y/N) <sup>5</sup>	Stony/Rocky (Y/N) <sup>6</sup>	Shallow to Bedrock (Y/N) <sup>7</sup>
								Water (Y/N) <sup>3</sup>	Wind (Y/N) <sup>4</sup>			
<b>24-Inch Pipeline (Continued)</b>												
<i>Greene County, Illinois (Continued)</i>												
10.0	675C2	Greenbush	95	0.03	N	N	N	N	N	Y	N	N
10.0	675B	Greenbush	90	0.02	Y	N	N	N	N	N	N	N
10.2	675C2	Greenbush	95	0.20	N	N	N	N	N	Y	N	N
10.3	3074A	Radford	90	0.09	N	N	N	N	N	N	N	N
10.4	280C2	Fayette	95	0.03	N	N	N	N	N	Y	N	N
10.4	675B	Greenbush	90	0.04	Y	N	N	N	N	N	N	N
10.5	61A	Atterberry	98	0.13	N	N	N	N	N	N	N	N
10.6	51B	Muscatune	95	0.06	Y	N	N	N	N	N	N	N
10.6	86C2	Oscos	90	0.08	N	N	N	N	N	Y	N	N
10.7	675C2	Greenbush	95	0.13	N	N	N	N	N	Y	N	N
10.8	86C2	Oscos	90	0.03	N	N	N	N	N	Y	N	N
10.9	51B	Muscatune	95	0.10	Y	N	N	N	N	N	N	N
11.0	51A	Muscatune	90	0.06	Y	N	N	N	N	N	N	N
11.0	51B	Muscatune	95	0.04	Y	N	N	N	N	N	N	N
11.1	51A	Muscatune	90	0.05	Y	N	N	N	N	N	N	N
11.1	51B	Muscatune	95	0.02	Y	N	N	N	N	N	N	N
11.1	86C2	Oscos	90	0.07	N	N	N	N	N	Y	N	N
11.3	51B	Muscatune	95	0.15	Y	N	N	N	N	N	N	N
11.6	47A	Viriden	90	0.29	N	Y	N	N	N	N	N	N
11.6	68A	Sable	85	0.04	N	N	N	N	N	N	N	N
11.7	47A	Viriden	90	0.07	N	Y	N	N	N	N	N	N
11.8	68A	Sable	85	0.11	N	N	N	N	N	N	N	N
12.0	51A	Muscatune	90	0.27	Y	N	N	N	N	N	N	N
12.2	68A	Sable	85	0.12	N	N	N	N	N	N	N	N
12.2	51B	Muscatune	95	0.02	Y	N	N	N	N	N	N	N
12.3	675B	Greenbush	90	0.10	Y	N	N	N	N	N	N	N
12.4	51B	Muscatune	95	0.05	Y	N	N	N	N	N	N	N
12.4	675B	Greenbush	90	0.02	Y	N	N	N	N	N	N	N





**Appendix 7-B. Soil Characteristics by MP Segment for Each Soil Map Unit along the Proposed Project (Continued)**

Nearest MP	Map Unit Symbol	Component Name	Component Percent	Crossing Length (miles)	Prime Farmland (Y/N) <sup>1</sup>	Hydric Soils (Y/N) <sup>1</sup>	Compaction Prone (Y/N) <sup>2</sup>	Highly Erodible		Revegetation Concerns (Y/N) <sup>5</sup>	Stony/Rocky (Y/N) <sup>6</sup>	Shallow to Bedrock (Y/N) <sup>7</sup>
								Water (Y/N) <sup>3</sup>	Wind (Y/N) <sup>4</sup>			
<b>24-Inch Pipeline (Continued)</b>												
<i>Greene County, Illinois (Continued)</i>												
12.5	675C2	Greenbush	95	0.12	N	N	N	N	N	Y	N	N
12.6	51B	Muscataune	95	0.06	Y	N	N	N	N	N	N	N
12.6	675C2	Greenbush	95	0.03	N	N	N	N	N	Y	N	N
12.6	280D	Fayette	92	0.02	N	N	N	N	N	Y	N	N
12.6	675C2	Greenbush	95	0.02	N	N	N	N	N	Y	N	N
12.7	675B	Greenbush	90	0.04	Y	N	N	N	N	N	N	N
12.7	47A	Virден	90	0.02	N	Y	N	N	N	N	N	N
12.8	675B	Greenbush	90	0.07	Y	N	N	N	N	N	N	N
12.8	47A	Virден	90	0.04	N	Y	N	N	N	N	N	N
12.9	675B	Greenbush	90	0.15	Y	N	N	N	N	N	N	N
13.0	280B	Fayette	97	0.13	Y	N	N	N	N	N	N	N
13.2	280D	Fayette	92	0.09	N	N	N	N	N	Y	N	N
13.2	3451A	Lawson	90	0.05	N	N	N	N	N	N	N	N
13.3	8F2	Hickory	90	0.02	N	N	N	Y	N	Y	N	N
13.3	280D2	Fayette	95	0.02	N	N	N	N	N	Y	N	N
13.3	280B	Fayette	97	0.02	Y	N	N	N	N	N	N	N
13.3	8F2	Hickory	90	0.07	N	N	N	Y	N	Y	N	N
13.4	280B	Fayette	97	0.08	Y	N	N	N	N	N	N	N
13.5	280D2	Fayette	95	0.06	N	N	N	N	N	Y	N	N
13.5	280B	Fayette	97	0.02	Y	N	N	N	N	N	N	N
13.6	280D2	Fayette	95	0.08	N	N	N	N	N	Y	N	N
13.6	280B	Fayette	97	0.05	Y	N	N	N	N	N	N	N
13.8	280D2	Fayette	95	0.14	N	N	N	N	N	Y	N	N
13.9	3451A	Lawson	90	0.59	N	N	N	N	N	N	N	N
14.4	675C2	Greenbush	95	0.06	N	N	N	N	N	Y	N	N
14.5	47A	Virден	90	0.11	N	Y	N	N	N	N	N	N
14.6	51B	Muscataune	95	0.16	Y	N	N	N	N	N	N	N
14.9	675C2	Greenbush	95	0.32	N	N	N	N	N	Y	N	N



**Appendix 7-B. Soil Characteristics by MP Segment for Each Soil Map Unit along the Proposed Project (Continued)**

Nearest MP	Map Unit Symbol	Component Name	Component Percent	Crossing Length (miles)	Prime Farmland (Y/N) <sup>1</sup>	Hydric Soils (Y/N) <sup>1</sup>	Compaction Prone (Y/N) <sup>2</sup>	Highly Erodible		Revegetation Concerns (Y/N) <sup>5</sup>	Stony/Rocky (Y/N) <sup>6</sup>	Shallow to Bedrock (Y/N) <sup>7</sup>
								Water (Y/N) <sup>3</sup>	Wind (Y/N) <sup>4</sup>			
<b>24-Inch Pipeline (Continued)</b>												
<i>Greene County, Illinois (Continued)</i>												
15.1	675B	Greenbush	90	0.14	Y	N	N	N	N	N	N	N
15.2	675C2	Greenbush	95	0.09	N	N	N	N	N	Y	N	N
15.3	675B	Greenbush	90	0.16	Y	N	N	N	N	N	N	N
15.5	61A	Atterberry	98	0.05	N	N	N	N	N	N	N	N
15.5	257B	Clarksdale	90	0.07	Y	N	N	N	N	N	N	N
15.6	61A	Atterberry	98	0.07	N	N	N	N	N	N	N	N
15.6	257B	Clarksdale	90	0.06	Y	N	N	N	N	N	N	N
15.7	280C2	Fayette	95	0.03	N	N	N	N	N	Y	N	N
15.7	47A	Virден	90	0.07	N	Y	N	N	N	N	N	N
15.8	257B	Clarksdale	90	0.17	Y	N	N	N	N	N	N	N
16.0	47A	Virден	90	0.12	N	Y	N	N	N	N	N	N
16.1	51A	Muscature	90	0.06	Y	N	N	N	N	N	N	N
16.2	51B	Muscature	95	0.08	Y	N	N	N	N	N	N	N
16.3	51A	Muscature	90	0.09	Y	N	N	N	N	N	N	N
16.3	47A	Virден	90	0.03	N	Y	N	N	N	N	N	N
16.4	61A	Atterberry	98	0.07	N	N	N	N	N	N	N	N
16.4	47A	Virден	90	0.02	N	Y	N	N	N	N	N	N
16.5	257B	Clarksdale	90	0.13	Y	N	N	N	N	N	N	N
16.6	47A	Virден	90	0.07	N	Y	N	N	N	N	N	N
16.6	257B	Clarksdale	90	0.03	Y	N	N	N	N	N	N	N
16.7	47A	Virден	90	0.06	N	Y	N	N	N	N	N	N
16.8	257B	Clarksdale	90	0.15	Y	N	N	N	N	N	N	N
16.9	280C2	Fayette	95	0.05	N	N	N	N	N	Y	N	N
16.9	280B	Fayette	97	0.02	Y	N	N	N	N	N	N	N
16.9	675C2	Greenbush	95	0.02	N	N	N	N	N	Y	N	N
16.9	280C2	Fayette	95	0.02	N	N	N	N	N	Y	N	N
17.0	257B	Clarksdale	90	0.09	Y	N	N	N	N	N	N	N
17.1	675C2	Greenbush	95	0.04	N	N	N	N	N	Y	N	N



**Appendix 7-B. Soil Characteristics by MP Segment for Each Soil Map Unit along the Proposed Project (Continued)**

Nearest MP	Map Unit Symbol	Component Name	Component Percent	Crossing Length (miles)	Prime Farmland (Y/N) <sup>1</sup>	Hydric Soils (Y/N) <sup>1</sup>	Compaction Prone (Y/N) <sup>2</sup>	Highly Erodible		Revegetation Concerns (Y/N) <sup>5</sup>	Stony/Rocky (Y/N) <sup>6</sup>	Shallow to Bedrock (Y/N) <sup>7</sup>
								Water (Y/N) <sup>3</sup>	Wind (Y/N) <sup>4</sup>			
<b>24-Inch Pipeline (Continued)</b>												
<i>Greene County, Illinois (Continued)</i>												
17.1	280D2	Fayette	95	0.01	N	N	N	N	N	Y	N	N
17.1	8F2	Hickory	90	0.03	N	N	N	Y	N	Y	N	N
17.2	280D2	Fayette	95	0.02	N	N	N	N	N	Y	N	N
17.2	280C2	Fayette	95	0.02	N	N	N	N	N	Y	N	N
17.2	280B	Fayette	97	0.01	Y	N	N	N	N	N	N	N
17.3	280C2	Fayette	95	0.13	N	N	N	N	N	Y	N	N
17.3	280B	Fayette	97	0.02	Y	N	N	N	N	N	N	N
17.4	280D2	Fayette	95	0.02	N	N	N	N	N	Y	N	N
17.4	17A	Keomah	90	0.06	N	N	N	N	N	N	N	N
17.5	280C2	Fayette	95	0.05	N	N	N	N	N	Y	N	N
17.5	280D2	Fayette	95	0.01	N	N	N	N	N	Y	N	N
17.5	280C2	Fayette	95	0.01	N	N	N	N	N	Y	N	N
17.5	280B	Fayette	97	0.00	Y	N	N	N	N	N	N	N
17.5	280C2	Fayette	95	0.01	N	N	N	N	N	Y	N	N
17.5	280B	Fayette	97	0.03	Y	N	N	N	N	N	N	N
17.6	280D2	Fayette	95	0.01	N	N	N	N	N	Y	N	N
17.6	280B	Fayette	97	0.03	Y	N	N	N	N	N	N	N
17.6	280D2	Fayette	95	0.05	N	N	N	N	N	Y	N	N
17.7	17A	Keomah	90	0.07	N	N	N	N	N	N	N	N
17.7	51A	Muscatune	90	0.01	Y	N	N	N	N	N	N	N
17.7	280C2	Fayette	95	0.03	N	N	N	N	N	Y	N	N
17.8	257B	Clarksdale	90	0.16	Y	N	N	N	N	N	N	N
18.0	61A	Atterberry	98	0.12	N	N	N	N	N	N	N	N
18.2	47A	Virden	90	0.17	N	Y	N	N	N	N	N	N
18.2	257B	Clarksdale	90	0.04	Y	N	N	N	N	N	N	N
18.3	280B	Fayette	97	0.06	Y	N	N	N	N	N	N	N
18.3	280C2	Fayette	95	0.08	N	N	N	N	N	Y	N	N
18.4	280B	Fayette	97	0.08	Y	N	N	N	N	N	N	N



**Appendix 7-B. Soil Characteristics by MP Segment for Each Soil Map Unit along the Proposed Project (Continued)**

Nearest MP	Map Unit Symbol	Component Name	Component Percent	Crossing Length (miles)	Prime Farmland (Y/N) <sup>1</sup>	Hydric Soils (Y/N) <sup>1</sup>	Compaction Prone (Y/N) <sup>2</sup>	Highly Erodible		Revegetation Concerns (Y/N) <sup>5</sup>	Stony/Rocky (Y/N) <sup>6</sup>	Shallow to Bedrock (Y/N) <sup>7</sup>
								Water (Y/N) <sup>3</sup>	Wind (Y/N) <sup>4</sup>			
<b>24-Inch Pipeline (Continued)</b>												
<i>Greene County, Illinois (Continued)</i>												
18.5	280C2	Fayette	95	0.05	N	N	N	N	N	Y	N	N
18.5	280B	Fayette	97	0.01	Y	N	N	N	N	N	N	N
18.6R	280C2	Fayette	95	0.04	N	N	N	N	N	Y	N	N
18.6R	280B	Fayette	97	0.05	Y	N	N	N	N	N	N	N
18.7R	280C2	Fayette	95	0.06	N	N	N	N	N	Y	N	N
18.7R	280D	Fayette	92	0.04	N	N	N	N	N	Y	N	N
18.7R	3451A	Lawson	90	0.05	N	N	N	N	N	N	N	N
18.8R	280D	Fayette	92	0.04	N	N	N	N	N	Y	N	N
18.8R	675B	Greenbush	90	0.04	Y	N	N	N	N	N	N	N
18.9	61A	Atterberry	98	0.08	N	N	N	N	N	N	N	N
18.9	675B	Greenbush	90	0.03	Y	N	N	N	N	N	N	N
19.0	280C2	Fayette	95	0.03	N	N	N	N	N	Y	N	N
19.0	675B	Greenbush	90	0.07	Y	N	N	N	N	N	N	N
19.1	675C2	Greenbush	95	0.03	N	N	N	N	N	Y	N	N
19.1	280D	Fayette	92	0.05	N	N	N	N	N	Y	N	N
19.2	675C2	Greenbush	95	0.06	N	N	N	N	N	Y	N	N
19.2	675B	Greenbush	90	0.10	Y	N	N	N	N	N	N	N
19.3	61A	Atterberry	98	0.16	N	N	N	N	N	N	N	N
19.5	51A	Muscatune	90	0.11	Y	N	N	N	N	N	N	N
19.6	51B	Muscatune	95	0.12	Y	N	N	N	N	N	N	N
19.8	68A	Sable	85	0.23	N	N	N	N	N	N	N	N
20.1	51A	Muscatune	90	0.21	Y	N	N	N	N	N	N	N
20.1	51B	Muscatune	95	0.03	Y	N	N	N	N	N	N	N
20.2	675B	Greenbush	90	0.06	Y	N	N	N	N	N	N	N
20.2	51B	Muscatune	95	0.04	Y	N	N	N	N	N	N	N
20.3	675B	Greenbush	90	0.13	Y	N	N	N	N	N	N	N
20.4	279C2	Rozetta	94	0.31	N	N	N	N	N	Y	N	N
20.8	675B	Greenbush	90	0.10	Y	N	N	N	N	N	N	N



**Appendix 7-B. Soil Characteristics by MP Segment for Each Soil Map Unit along the Proposed Project (Continued)**

Nearest MP	Map Unit Symbol	Component Name	Component Percent	Crossing Length (miles)	Prime Farmland (Y/N) <sup>1</sup>	Hydric Soils (Y/N) <sup>1</sup>	Compaction Prone (Y/N) <sup>2</sup>	Highly Erodible		Revegetation Concerns (Y/N) <sup>5</sup>	Stony/Rocky (Y/N) <sup>6</sup>	Shallow to Bedrock (Y/N) <sup>7</sup>
								Water (Y/N) <sup>3</sup>	Wind (Y/N) <sup>4</sup>			
<b>24-Inch Pipeline (Continued)</b>												
<i>Greene County, Illinois (Continued)</i>												
20.8	279D2	Rozetta	94	0.04	N	N	N	N	N	Y	N	N
20.9	8D2	Hickory	90	0.03	N	N	N	N	N	Y	N	N
20.9	279D2	Rozetta	94	0.07	N	N	N	N	N	Y	N	N
21.0	279B	Rozetta	90	0.02	Y	N	N	N	N	N	N	N
21.0	61A	Atterberry	98	0.03	N	N	N	N	N	N	N	N
21.0	279B	Rozetta	90	0.02	Y	N	N	N	N	N	N	N
21.0	279C2	Rozetta	94	0.03	N	N	N	N	N	Y	N	N
21.1	675B	Greenbush	90	0.05	Y	N	N	N	N	N	N	N
21.1	47A	Virден	90	0.03	N	Y	N	N	N	N	N	N
21.2	675B	Greenbush	90	0.22	Y	N	N	N	N	N	N	N
21.4	68A	Sable	85	0.13	N	N	N	N	N	N	N	N
21.5	61A	Atterberry	98	0.04	N	N	N	N	N	N	N	N
21.5	257B	Clarksdale	90	0.04	Y	N	N	N	N	N	N	N
21.6	47A	Virден	90	0.05	N	Y	N	N	N	N	N	N
21.6	257B	Clarksdale	90	0.05	Y	N	N	N	N	N	N	N
21.7	68A	Sable	85	0.04	N	N	N	N	N	N	N	N
21.7	47A	Virден	90	0.09	N	Y	N	N	N	N	N	N
21.8	68A	Sable	85	0.08	N	N	N	N	N	N	N	N
21.9	51A	Muscatune	90	0.10	Y	N	N	N	N	N	N	N
22.0	51B	Muscatune	95	0.08	Y	N	N	N	N	N	N	N
22.2	47A	Virден	90	0.20	N	Y	N	N	N	N	N	N
22.3	61A	Atterberry	98	0.07	N	N	N	N	N	N	N	N
22.3	675C2	Greenbush	95	0.04	N	N	N	N	N	Y	N	N
22.4	279C2	Rozetta	94	0.04	N	N	N	N	N	Y	N	N
22.4	675C2	Greenbush	95	0.01	N	N	N	N	N	Y	N	N
22.4	279C2	Rozetta	94	0.05	N	N	N	N	N	Y	N	N
22.5	675B	Greenbush	90	0.03	Y	N	N	N	N	N	N	N
22.5	675C2	Greenbush	95	0.09	N	N	N	N	N	Y	N	N



**Appendix 7-B. Soil Characteristics by MP Segment for Each Soil Map Unit along the Proposed Project (Continued)**

Nearest MP	Map Unit Symbol	Component Name	Component Percent	Crossing Length (miles)	Prime Farmland (Y/N) <sup>1</sup>	Hydric Soils (Y/N) <sup>1</sup>	Compaction Prone (Y/N) <sup>2</sup>	Highly Erodible		Revegetation Concerns (Y/N) <sup>5</sup>	Stony/Rocky (Y/N) <sup>6</sup>	Shallow to Bedrock (Y/N) <sup>7</sup>
								Water (Y/N) <sup>3</sup>	Wind (Y/N) <sup>4</sup>			
<b>24-Inch Pipeline (Continued)</b>												
<i>Greene County, Illinois (Continued)</i>												
22.6	675B	Greenbush	90	0.01	Y	N	N	N	N	N	N	N
22.6	675C2	Greenbush	95	0.04	N	N	N	N	N	Y	N	N
22.7	51A	Muscature	90	0.06	Y	N	N	N	N	N	N	N
22.7	279C2	Rozetta	94	0.01	N	N	N	N	N	Y	N	N
22.7	675B	Greenbush	90	0.02	Y	N	N	N	N	N	N	N
22.7	279C2	Rozetta	94	0.02	N	N	N	N	N	Y	N	N
22.8	675B	Greenbush	90	0.05	Y	N	N	N	N	N	N	N
22.8	279C2	Rozetta	94	0.01	N	N	N	N	N	Y	N	N
22.8	675B	Greenbush	90	0.04	Y	N	N	N	N	N	N	N
22.8	61A	Atterberry	98	0.02	N	N	N	N	N	N	N	N
23.0	51A	Muscature	90	0.17	Y	N	N	N	N	N	N	N
23.1	68A	Sable	85	0.06	N	N	N	N	N	N	N	N
23.1	61A	Atterberry	98	0.07	N	N	N	N	N	N	N	N
23.2	280C2	Fayette	95	0.10	N	N	N	N	N	Y	N	N
23.3	280B	Fayette	97	0.05	Y	N	N	N	N	N	N	N
23.3	280C2	Fayette	95	0.07	N	N	N	N	N	Y	N	N
23.4	280B	Fayette	97	0.05	Y	N	N	N	N	N	N	N
23.4	280C2	Fayette	95	0.01	N	N	N	N	N	Y	N	N
23.5	280D	Fayette	92	0.06	N	N	N	N	N	Y	N	N
23.5	280B	Fayette	97	0.06	Y	N	N	N	N	N	N	N
23.6	17A	Keomah	90	0.08	N	N	N	N	N	N	N	N
23.7	280B	Fayette	97	0.10	Y	N	N	N	N	N	N	N
23.8	280D2	Fayette	95	0.05	N	N	N	N	N	Y	N	N
23.8	280B	Fayette	97	0.01	Y	N	N	N	N	N	N	N
23.9	280D2	Fayette	95	0.08	N	N	N	N	N	Y	N	N
23.9	280B	Fayette	97	0.05	Y	N	N	N	N	N	N	N
24.0	280D2	Fayette	95	0.09	N	N	N	N	N	Y	N	N
24.1	280B	Fayette	97	0.13	Y	N	N	N	N	N	N	N



**Appendix 7-B. Soil Characteristics by MP Segment for Each Soil Map Unit along the Proposed Project (Continued)**

Nearest MP	Map Unit Symbol	Component Name	Component Percent	Crossing Length (miles)	Prime Farmland (Y/N) <sup>1</sup>	Hydric Soils (Y/N) <sup>1</sup>	Compaction Prone (Y/N) <sup>2</sup>	Highly Erodible		Revegetation Concerns (Y/N) <sup>5</sup>	Stony/Rocky (Y/N) <sup>6</sup>	Shallow to Bedrock (Y/N) <sup>7</sup>
								Water (Y/N) <sup>3</sup>	Wind (Y/N) <sup>4</sup>			
<b>24-Inch Pipeline (Continued)</b>												
<i>Greene County, Illinois (Continued)</i>												
24.2	280D2	Fayette	95	0.06	N	N	N	N	N	Y	N	N
24.3	280B	Fayette	97	0.07	Y	N	N	N	N	N	N	N
24.3	280C2	Fayette	95	0.02	N	N	N	N	N	Y	N	N
24.3	280B	Fayette	97	0.05	Y	N	N	N	N	N	N	N
24.4	280C2	Fayette	95	0.03	N	N	N	N	N	Y	N	N
24.4	280B	Fayette	97	0.04	Y	N	N	N	N	N	N	N
24.4	8D	Hickory	90	0.05	N	N	N	N	N	Y	N	N
24.5R	280B	Fayette	97	0.09	Y	N	N	N	N	N	N	N
24.6R	8D	Hickory	90	0.10	N	N	N	N	N	Y	N	N
24.7R	8D2	Hickory	90	0.10	N	N	N	N	N	Y	N	N
24.8R	280B	Fayette	97	0.01	Y	N	N	N	N	N	N	N
24.8R	8D2	Hickory	90	0.09	N	N	N	N	N	Y	N	N
24.9R	134C2	Camden	97	0.03	N	N	N	N	N	Y	N	N
24.9R	3331A	Haymond	90	0.04	N	N	N	N	N	N	N	N
25.0R	3451A	Lawson	90	0.31	N	N	N	N	N	N	N	N
25.3R	3070A	Beaucoup	90	0.03	N	Y	N	N	N	N	N	N
25.3R	W	Water	N/A	0.02	N/A	N/A	N/A	N/A	N/A	N/A	N/A	N/A
25.3R	3070A	Beaucoup	90	0.13	N	Y	N	N	N	N	N	N
25.5R	3451A	Lawson	90	0.12	N	N	N	N	N	N	N	N
25.6R	7148A	Proctor	95	0.06	Y	N	N	N	N	N	N	N
25.7R	3451A	Lawson	90	0.12	N	N	N	N	N	N	N	N
25.7R	7148A	Proctor	95	0.01	Y	N	N	N	N	N	N	N
25.8R	3451A	Lawson	90	0.10	N	N	N	N	N	N	N	N
25.8R	8D2	Hickory	90	0.03	N	N	N	N	N	Y	N	N
26.0	280D2	Fayette	95	0.04	N	N	N	N	N	Y	N	N
26.0	675B	Greenbush	90	0.12	Y	N	N	N	N	N	N	N
26.1	675C2	Greenbush	95	0.05	N	N	N	N	N	Y	N	N
26.2	257B	Clarksdale	90	0.08	Y	N	N	N	N	N	N	N



**Appendix 7-B. Soil Characteristics by MP Segment for Each Soil Map Unit along the Proposed Project (Continued)**

Nearest MP	Map Unit Symbol	Component Name	Component Percent	Crossing Length (miles)	Prime Farmland (Y/N) <sup>1</sup>	Hydric Soils (Y/N) <sup>2</sup>	Compaction Prone (Y/N) <sup>2</sup>	Highly Erodible		Revegetation Concerns (Y/N) <sup>5</sup>	Stony/Rocky (Y/N) <sup>6</sup>	Shallow to Bedrock (Y/N) <sup>7</sup>
								Water (Y/N) <sup>3</sup>	Wind (Y/N) <sup>4</sup>			
<b>24-Inch Pipeline (Continued)</b>												
<i>Greene County, Illinois (Continued)</i>												
26.3	51A	Muscatune	90	0.17	Y	N	N	N	N	N	N	N
26.4	61A	Atterberry	98	0.02	N	N	N	N	N	N	N	N
26.5	675B	Greenbush	90	0.27	Y	N	N	N	N	N	N	N
26.7	280D2	Fayette	95	0.05	N	N	N	N	N	Y	N	N
26.7	675C2	Greenbush	95	0.03	N	N	N	N	N	Y	N	N
26.8	257B	Clarksdale	90	0.04	Y	N	N	N	N	N	N	N
26.8	675C2	Greenbush	95	0.10	N	N	N	N	N	Y	N	N
26.9	257B	Clarksdale	90	0.05	Y	N	N	N	N	N	N	N
27.0	675C2	Greenbush	95	0.02	N	N	N	N	N	Y	N	N
27.0	257B	Clarksdale	90	0.05	Y	N	N	N	N	N	N	N
27.2	51B	Muscatune	95	0.27	Y	N	N	N	N	N	N	N
27.3	675B	Greenbush	90	0.06	Y	N	N	N	N	N	N	N
27.4	257B	Clarksdale	90	0.14	Y	N	N	N	N	N	N	N
27.6	61A	Atterberry	98	0.18	N	N	N	N	N	N	N	N
27.7	675B	Greenbush	90	0.03	Y	N	N	N	N	N	N	N
27.8	51A	Muscatune	90	0.93	Y	N	N	N	N	N	N	N
28.9	68A	Sable	85	0.30	N	N	N	N	N	N	N	N
29.0	51A	Muscatune	90	0.18	Y	N	N	N	N	N	N	N
29.2	68A	Sable	85	0.13	N	N	N	N	N	N	N	N
29.2	45A	Denny	95	0.05	N	Y	N	N	N	N	N	N
29.3	68A	Sable	85	0.00	N	N	N	N	N	N	N	N
29.3	45A	Denny	95	0.03	N	Y	N	N	N	N	N	N
29.3	68A	Sable	85	0.07	N	N	N	N	N	N	N	N
29.4	51A	Muscatune	90	0.03	Y	N	N	N	N	N	N	N
<i>Jersey County, Illinois</i>												
29.4	51A	Muscatune	90	0.06	Y	N	N	N	N	N	N	N
29.5	675B	Greenbush	90	0.04	Y	N	N	N	N	N	N	N
29.6	51A	Muscatune	90	0.12	Y	N	N	N	N	N	N	N





**Appendix 7-B. Soil Characteristics by MP Segment for Each Soil Map Unit along the Proposed Project (Continued)**

Nearest MP	Map Unit Symbol	Component Name	Component Percent	Crossing Length (miles)	Prime Farmland (Y/N) <sup>1</sup>	Hydric Soils (Y/N) <sup>2</sup>	Compaction Prone (Y/N) <sup>2</sup>	Highly Erodible		Revegetation Concerns (Y/N) <sup>5</sup>	Stony/Rocky (Y/N) <sup>6</sup>	Shallow to Bedrock (Y/N) <sup>7</sup>
								Water (Y/N) <sup>3</sup>	Wind (Y/N) <sup>4</sup>			
<b>24-Inch Pipeline (Continued)</b>												
<i>Jersey County, Illinois (Continued)</i>												
29.6	675B	Greenbush	90	0.03	Y	N	N	N	N	N	N	N
29.7	51A	Muscatune	90	0.14	Y	N	N	N	N	N	N	N
29.9	68A	Sable	85	0.34	N	Y	N	N	N	N	N	N
30.2	51A	Muscatune	90	0.10	Y	N	N	N	N	N	N	N
30.4	68A	Sable	85	0.26	N	Y	N	N	N	N	N	N
30.5	51A	Muscatune	90	0.05	Y	N	N	N	N	N	N	N
30.6	68A	Sable	85	0.07	N	Y	N	N	N	N	N	N
30.7	51A	Muscatune	90	0.09	Y	N	N	N	N	N	N	N
30.7	675B	Greenbush	90	0.09	Y	N	N	N	N	N	N	N
30.8	279C3	Rozetta	94	0.02	N	N	N	Y	N	Y	N	N
30.9	675B	Greenbush	90	0.12	Y	N	N	N	N	N	N	N
30.9	279C3	Rozetta	94	0.02	N	N	N	Y	N	Y	N	N
31.0	675B	Greenbush	90	0.07	Y	N	N	N	N	N	N	N
31.1	51A	Muscatune	90	0.17	Y	N	N	N	N	N	N	N
31.2	675B	Greenbush	90	0.00	Y	N	N	N	N	N	N	N
31.2	86B	Oscos	90	0.10	Y	N	N	N	N	N	N	N
31.3	51A	Muscatune	90	0.14	Y	N	N	N	N	N	N	N
31.4	675C2	Greenbush	95	0.02	N	N	N	N	N	Y	N	N
31.5	675B	Greenbush	90	0.08	Y	N	N	N	N	N	N	N
31.6	675C2	Greenbush	95	0.04	N	N	N	N	N	Y	N	N
31.6	3451A	Lawson	92	0.07	N	N	N	N	N	N	N	N
31.7	279C3	Rozetta	94	0.01	N	N	N	Y	N	Y	N	N
31.7	675C2	Greenbush	95	0.06	N	N	N	N	N	Y	N	N
31.7	675B	Greenbush	90	0.03	Y	N	N	N	N	N	N	N
31.8	61A	Atterberry	98	0.06	N	N	N	N	N	N	N	N
31.8	675B	Greenbush	90	0.06	Y	N	N	N	N	N	N	N
31.9	675C2	Greenbush	95	0.06	N	N	N	N	N	Y	N	N
31.9	3451A	Lawson	92	0.03	N	N	N	N	N	N	N	N



**Appendix 7-B. Soil Characteristics by MP Segment for Each Soil Map Unit along the Proposed Project (Continued)**

Nearest MP	Map Unit Symbol	Component Name	Component Percent	Crossing Length (miles)	Prime Farmland (Y/N) <sup>1</sup>	Hydric Soils (Y/N) <sup>1</sup>	Compaction Prone (Y/N) <sup>2</sup>	Highly Erodible		Revegetation Concerns (Y/N) <sup>5</sup>	Stony/Rocky (Y/N) <sup>6</sup>	Shallow to Bedrock (Y/N) <sup>7</sup>
								Water (Y/N) <sup>3</sup>	Wind (Y/N) <sup>4</sup>			
<b>24-Inch Pipeline (Continued)</b>												
<i>Jersey County, Illinois (Continued)</i>												
32.0	675C2	Greenbush	95	0.10	N	N	N	N	N	Y	N	N
32.1	675B	Greenbush	90	0.02	Y	N	N	N	N	N	N	N
32.2	86B	Oscos	90	0.14	Y	N	N	N	N	N	N	N
32.3	51A	Muscatune	90	0.33	Y	N	N	N	N	N	N	N
32.6	68A	Sable	85	0.13	N	Y	N	N	N	N	N	N
32.7	51A	Muscatune	90	0.13	Y	N	N	N	N	N	N	N
32.9	68A	Sable	85	0.36	N	Y	N	N	N	N	N	N
33.2	51A	Muscatune	90	0.15	Y	N	N	N	N	N	N	N
33.4	68A	Sable	85	0.19	N	Y	N	N	N	N	N	N
33.6	51A	Muscatune	90	0.15	Y	N	N	N	N	N	N	N
33.7	86B	Oscos	90	0.03	Y	N	N	N	N	N	N	N
33.8	259C2	Assumption	90	0.13	N	N	N	N	N	Y	N	N
33.9	86B	Oscos	90	0.08	Y	N	N	N	N	N	N	N
33.9	259C2	Assumption	90	0.02	N	N	N	N	N	Y	N	N
33.9	86B	Oscos	90	0.03	Y	N	N	N	N	N	N	N
34.1	51A	Muscatune	90	0.23	Y	N	N	N	N	N	N	N
34.2	675B	Greenbush	90	0.03	Y	N	N	N	N	N	N	N
34.3	61A	Atterberry	98	0.06	N	N	N	N	N	N	N	N
34.3	675B	Greenbush	90	0.08	Y	N	N	N	N	N	N	N
34.5	61A	Atterberry	98	0.17	N	N	N	N	N	N	N	N
34.5	675B	Greenbush	90	0.02	Y	N	N	N	N	N	N	N
34.6	61A	Atterberry	98	0.04	N	N	N	N	N	N	N	N
34.6	675B	Greenbush	90	0.07	Y	N	N	N	N	N	N	N
34.7	119C2	Elco	97	0.04	N	N	N	N	N	Y	N	N
34.8	675B	Greenbush	90	0.23	Y	N	N	N	N	N	N	N
35.0	279B	Rozetta	90	0.08	Y	N	N	N	N	N	N	N
35.0	119C2	Elco	97	0.04	N	N	N	N	N	Y	N	N
35.1R	279B	Rozetta	90	0.05	Y	N	N	N	N	N	N	N



**Appendix 7-B. Soil Characteristics by MP Segment for Each Soil Map Unit along the Proposed Project (Continued)**

Nearest MP	Map Unit Symbol	Component Name	Component Percent	Crossing Length (miles)	Prime Farmland (Y/N) <sup>1</sup>	Hydric Soils (Y/N) <sup>1</sup>	Compaction Prone (Y/N) <sup>2</sup>	Highly Erodible		Revegetation Concerns (Y/N) <sup>5</sup>	Stony/Rocky (Y/N) <sup>6</sup>	Shallow to Bedrock (Y/N) <sup>7</sup>
								Water (Y/N) <sup>3</sup>	Wind (Y/N) <sup>4</sup>			
<b>24-Inch Pipeline (Continued)</b>												
<i>Jersey County, Illinois (Continued)</i>												
35.1R	119D2	Elco	94	0.07	N	N	N	N	N	Y	N	N
35.2R	3634A	Blyton	90	0.10	N	N	N	N	N	N	N	N
35.3R	8D2	Hickory	90	0.02	N	N	N	N	N	Y	N	N
35.3R	119C3	Elco	95	0.01	N	N	N	Y	N	Y	N	N
35.3R	279B	Rozetta	90	0.05	Y	N	N	N	N	N	N	N
35.4R	279C2	Rozetta	94	0.02	N	N	N	N	N	Y	N	N
35.4R	515C3	Bunkum	93	0.05	N	N	N	Y	N	Y	N	N
35.4R	279C2	Rozetta	94	0.03	N	N	N	N	N	Y	N	N
35.4R	515C3	Bunkum	93	0.01	N	N	N	Y	N	Y	N	N
35.5R	119D2	Elco	94	0.01	N	N	N	N	N	Y	N	N
35.5R	8D2	Hickory	90	0.04	N	N	N	N	N	Y	N	N
35.5R	119D2	Elco	94	0.02	N	N	N	N	N	Y	N	N
35.5R	279B	Rozetta	90	0.05	Y	N	N	N	N	N	N	N
35.6R	119C2	Elco	97	0.05	N	N	N	N	N	Y	N	N
35.6R	279B	Rozetta	90	0.06	Y	N	N	N	N	N	N	N
35.7R	119C2	Elco	97	0.01	N	N	N	N	N	Y	N	N
35.7R	8D2	Hickory	90	0.05	N	N	N	N	N	Y	N	N
35.7R	119C2	Elco	97	0.01	N	N	N	N	N	Y	N	N
35.8R	279B	Rozetta	90	0.06	Y	N	N	N	N	N	N	N
35.9R	16A	Rushville	90	0.12	N	Y	N	N	N	N	N	N
35.9R	279B	Rozetta	90	0.03	Y	N	N	N	N	N	N	N
36.0R	119C3	Elco	95	0.09	N	N	N	Y	N	Y	N	N
36.1R	279B	Rozetta	90	0.09	Y	N	N	N	N	N	N	N
36.2R	119C3	Elco	95	0.03	N	N	N	Y	N	Y	N	N
36.2R	279B	Rozetta	90	0.04	Y	N	N	N	N	N	N	N
36.2R	515C3	Bunkum	93	0.01	N	N	N	Y	N	Y	N	N
36.3R	279B	Rozetta	90	0.10	Y	N	N	N	N	N	N	N
36.3R	515C3	Bunkum	93	0.02	N	N	N	Y	N	Y	N	N



**Appendix 7-B. Soil Characteristics by MP Segment for Each Soil Map Unit along the Proposed Project (Continued)**

Nearest MP	Map Unit Symbol	Component Name	Component Percent	Crossing Length (miles)	Prime Farmland (Y/N) <sup>1</sup>	Hydric Soils (Y/N) <sup>1</sup>	Compaction Prone (Y/N) <sup>2</sup>	Highly Erodible		Revegetation Concerns (Y/N) <sup>5</sup>	Stony/Rocky (Y/N) <sup>6</sup>	Shallow to Bedrock (Y/N) <sup>7</sup>
								Water (Y/N) <sup>3</sup>	Wind (Y/N) <sup>4</sup>			
<b>24-Inch Pipeline (Continued)</b>												
<i>Jersey County, Illinois (Continued)</i>												
36.3R	119D3	Elco	95	0.01	N	N	N	Y	N	Y	N	N
36.4R	515C3	Bunkum	93	0.01	N	N	N	Y	N	Y	N	N
36.4R	279B	Rozetta	90	0.04	Y	N	N	N	N	N	N	N
36.4R	119D3	Elco	95	0.03	N	N	N	Y	N	Y	N	N
36.4R	8D3	Hickory	90	0.03	N	N	N	Y	N	Y	N	N
36.5R	3634A	Blyton	90	0.08	N	N	N	N	N	N	N	N
36.5R	3333A	Wakeland	90	0.02	N	N	N	N	N	N	N	N
36.6R	3634A	Blyton	90	0.17	N	N	N	N	N	N	N	N
36.7R	8G	Hickory	90	0.03	N	N	N	Y	N	Y	N	N
36.8R	280B	Fayette	90	0.08	Y	N	N	N	N	N	N	N
36.9R	119D3	Elco	95	0.06	N	N	N	Y	N	Y	N	N
37.0R	279B	Rozetta	90	0.17	Y	N	N	N	N	N	N	N
37.1R	515C2	Bunkum	92	0.03	N	N	N	N	N	Y	N	N
37.1	515B2	Bunkum	90	0.16	Y	N	N	N	N	N	N	N
37.1	515C2	Bunkum	92	0.02	N	N	N	N	N	Y	N	N
37.1	515B2	Bunkum	90	0.02	Y	N	N	N	N	N	N	N
37.2	515C2	Bunkum	92	0.03	N	N	N	N	N	Y	N	N
37.2	675B	Greenbush	90	0.02	Y	N	N	N	N	N	N	N
37.2	515C2	Bunkum	92	0.05	N	N	N	N	N	Y	N	N
37.3	675B	Greenbush	90	0.03	Y	N	N	N	N	N	N	N
37.3	515C2	Bunkum	92	0.04	N	N	N	N	N	Y	N	N
37.3	675B	Greenbush	90	0.03	Y	N	N	N	N	N	N	N
37.4	515C2	Bunkum	92	0.14	N	N	N	N	N	Y	N	N
37.7	675B	Greenbush	90	0.56	Y	N	N	N	N	N	N	N
38.2	61A	Atterberry	98	0.19	N	N	N	N	N	N	N	N
38.3	675B	Greenbush	90	0.05	Y	N	N	N	N	N	N	N
38.4	279C2	Rozetta	94	0.11	N	N	N	N	N	Y	N	N
38.4	675B	Greenbush	90	0.03	Y	N	N	N	N	N	N	N



**Appendix 7-B. Soil Characteristics by MP Segment for Each Soil Map Unit along the Proposed Project (Continued)**

Nearest MP	Map Unit Symbol	Component Name	Component Percent	Crossing Length (miles)	Prime Farmland (Y/N) <sup>1</sup>	Hydric Soils (Y/N) <sup>1</sup>	Compaction Prone (Y/N) <sup>2</sup>	Highly Erodible		Revegetation Concerns (Y/N) <sup>5</sup>	Stony/Rocky (Y/N) <sup>6</sup>	Shallow to Bedrock (Y/N) <sup>7</sup>
								Water (Y/N) <sup>3</sup>	Wind (Y/N) <sup>4</sup>			
<b>24-Inch Pipeline (Continued)</b>												
<i>Jersey County, Illinois (Continued)</i>												
38.5	279C2	Rozetta	94	0.06	N	N	N	N	N	Y	N	N
38.5	675B	Greenbush	90	0.09	Y	N	N	N	N	N	N	N
38.6	279C2	Rozetta	94	0.02	N	N	N	N	N	Y	N	N
38.7	119D3	Elco	95	0.08	N	N	N	Y	N	Y	N	N
38.7	279C2	Rozetta	94	0.01	N	N	N	N	N	Y	N	N
38.8	279B	Rozetta	90	0.17	Y	N	N	N	N	N	N	N
38.9	279C2	Rozetta	94	0.06	N	N	N	N	N	Y	N	N
39.0	279B	Rozetta	90	0.02	Y	N	N	N	N	N	N	N
39.0	279C2	Rozetta	94	0.01	N	N	N	N	N	Y	N	N
39.0	119D3	Elco	95	0.08	N	N	N	Y	N	Y	N	N
39.1	279B	Rozetta	90	0.03	Y	N	N	N	N	N	N	N
39.1	279C3	Rozetta	94	0.00	N	N	N	Y	N	Y	N	N
39.1	119D3	Elco	95	0.04	N	N	N	Y	N	Y	N	N
39.1	279C3	Rozetta	94	0.01	N	N	N	Y	N	Y	N	N
39.2	119D3	Elco	95	0.06	N	N	N	Y	N	Y	N	N
39.3	279B	Rozetta	90	0.14	Y	N	N	N	N	N	N	N
39.4	119D2	Elco	94	0.12	N	N	N	N	N	Y	N	N
39.5	279B	Rozetta	90	0.01	Y	N	N	N	N	N	N	N
39.5	119D2	Elco	94	0.05	N	N	N	N	N	Y	N	N
39.5	279B	Rozetta	90	0.04	Y	N	N	N	N	N	N	N
39.6	280C	Fayette	95	0.04	N	N	N	N	N	Y	N	N
39.6	8D2	Hickory	90	0.05	N	N	N	N	N	Y	N	N
39.6	280C	Fayette	95	0.02	N	N	N	N	N	Y	N	N
39.7	8D2	Hickory	90	0.06	N	N	N	N	N	Y	N	N
39.8R	8F2	Hickory	90	0.07	N	N	N	Y	N	Y	N	N
39.9R	279B	Rozetta	90	0.22	Y	N	N	N	N	N	N	N
40.0R	278A	Stronghurst	90	0.05	N	N	N	N	N	N	N	N
40.1R	279C2	Rozetta	94	0.04	N	N	N	N	N	Y	N	N



**Appendix 7-B. Soil Characteristics by MP Segment for Each Soil Map Unit along the Proposed Project (Continued)**

Nearest MP	Map Unit Symbol	Component Name	Component Percent	Crossing Length (miles)	Prime Farmland (Y/N) <sup>1</sup>	Hydric Soils (Y/N) <sup>2</sup>	Compaction Prone (Y/N) <sup>2</sup>	Highly Erodible		Revegetation Concerns (Y/N) <sup>5</sup>	Stony/Rocky (Y/N) <sup>6</sup>	Shallow to Bedrock (Y/N) <sup>7</sup>
								Water (Y/N) <sup>3</sup>	Wind (Y/N) <sup>4</sup>			
<b>24-Inch Pipeline (Continued)</b>												
<i>Jersey County, Illinois (Continued)</i>												
40.2R	278A	Stronghurst	90	0.11	N	N	N	N	N	N	N	N
40.2R	61A	Atterberry	98	0.07	N	N	N	N	N	N	N	N
40.3	51A	Muscature	90	0.06	Y	N	N	N	N	N	N	N
40.4	61A	Atterberry	98	0.04	N	N	N	N	N	N	N	N
40.4	51A	Muscature	90	0.03	Y	N	N	N	N	N	N	N
40.4	61A	Atterberry	98	0.08	N	N	N	N	N	N	N	N
40.5	675B	Greenbush	90	0.09	Y	N	N	N	N	N	N	N
40.6	280D3	Fayette	95	0.10	N	N	N	Y	N	Y	N	N
40.7	280B	Fayette	90	0.07	Y	N	N	N	N	N	N	N
40.8	280C2	Fayette	95	0.05	N	N	N	N	N	Y	N	N
40.8	280D3	Fayette	95	0.07	N	N	N	Y	N	Y	N	N
40.9	280C2	Fayette	95	0.02	N	N	N	N	N	Y	N	N
40.9	280D3	Fayette	95	0.05	N	N	N	Y	N	Y	N	N
41.0	280C2	Fayette	95	0.08	N	N	N	N	N	Y	N	N
41.1	280D3	Fayette	95	0.17	N	N	N	Y	N	Y	N	N
41.2	280C2	Fayette	95	0.07	N	N	N	N	N	Y	N	N
41.3	279C2	Rozetta	94	0.11	N	N	N	N	N	Y	N	N
41.4	280C2	Fayette	95	0.04	N	N	N	N	N	Y	N	N
41.4	279C2	Rozetta	94	0.03	N	N	N	N	N	Y	N	N
41.5	280C2	Fayette	95	0.02	N	N	N	N	N	Y	N	N
41.5	279D3	Rozetta	94	0.11	N	N	N	Y	N	Y	N	N
41.6	279B	Rozetta	90	0.03	Y	N	N	N	N	N	N	N
41.7	279C2	Rozetta	94	0.08	N	N	N	N	N	Y	N	N
41.7	279B	Rozetta	90	0.02	Y	N	N	N	N	N	N	N
41.7	279C2	Rozetta	94	0.01	N	N	N	N	N	Y	N	N
41.7	279D3	Rozetta	94	0.03	N	N	N	Y	N	Y	N	N
41.8	279C2	Rozetta	94	0.12	N	N	N	N	N	Y	N	N
41.9	279B	Rozetta	90	0.02	Y	N	N	N	N	N	N	N



**Appendix 7-B. Soil Characteristics by MP Segment for Each Soil Map Unit along the Proposed Project (Continued)**

Nearest MP	Map Unit Symbol	Component Name	Component Percent	Crossing Length (miles)	Prime Farmland (Y/N) <sup>1</sup>	Hydric Soils (Y/N) <sup>1</sup>	Compaction Prone (Y/N) <sup>2</sup>	Highly Erodible		Revegetation Concerns (Y/N) <sup>5</sup>	Stony/Rocky (Y/N) <sup>6</sup>	Shallow to Bedrock (Y/N) <sup>7</sup>
								Water (Y/N) <sup>3</sup>	Wind (Y/N) <sup>4</sup>			
<b>24-Inch Pipeline (Continued)</b>												
<i>Jersey County, Illinois (Continued)</i>												
41.9	279C2	Rozetta	94	0.03	N	N	N	N	N	Y	N	N
41.9	279B	Rozetta	90	0.02	Y	N	N	N	N	N	N	N
42.0	279D2	Rozetta	94	0.06	N	N	N	N	N	Y	N	N
42.0	279B	Rozetta	90	0.05	Y	N	N	N	N	N	N	N
42.1	279C2	Rozetta	94	0.03	N	N	N	N	N	Y	N	N
42.1	279B	Rozetta	90	0.03	Y	N	N	N	N	N	N	N
42.1	278A	Stronghurst	90	0.04	N	N	N	N	N	N	N	N
42.2	279C2	Rozetta	94	0.05	N	N	N	N	N	Y	N	N
42.3	279B	Rozetta	90	0.14	Y	N	N	N	N	N	N	N
42.3	61A	Atterberry	98	0.05	N	N	N	N	N	N	N	N
42.4	279B	Rozetta	90	0.04	Y	N	N	N	N	N	N	N
42.4	279C2	Rozetta	94	0.01	N	N	N	N	N	Y	N	N
42.4	477D3	Winfield	90	0.03	N	N	N	Y	N	Y	N	N
42.5	279C2	Rozetta	94	0.02	N	N	N	N	N	Y	N	N
42.5	477D3	Winfield	90	0.03	N	N	N	Y	N	Y	N	N
42.5	279C2	Rozetta	94	0.04	N	N	N	N	N	Y	N	N
42.7	279B	Rozetta	90	0.17	Y	N	N	N	N	N	N	N
42.7	477C2	Winfield	95	0.03	N	N	N	N	N	Y	N	N
42.8	279B	Rozetta	90	0.06	Y	N	N	N	N	N	N	N
42.8	278A	Stronghurst	90	0.06	N	N	N	N	N	N	N	N
43.0	477B	Winfield	95	0.20	Y	N	N	N	N	N	N	N
43.1	477C2	Winfield	95	0.03	N	N	N	N	N	Y	N	N
43.4	477B	Winfield	95	0.57	Y	N	N	N	N	N	N	N
43.7R	477C2	Winfield	95	0.03	N	N	N	N	N	Y	N	N
43.9	477B	Winfield	95	0.25	Y	N	N	N	N	N	N	N
44.0	79C2	Menfro	85	0.03	N	N	N	N	N	Y	N	N
44.0	79B	Menfro	90	0.03	Y	N	N	N	N	N	N	N
44.0	79C2	Menfro	85	0.04	N	N	N	N	N	Y	N	N



**Appendix 7-B. Soil Characteristics by MP Segment for Each Soil Map Unit along the Proposed Project (Continued)**

Nearest MP	Map Unit Symbol	Component Name	Component Percent	Crossing Length (miles)	Prime Farmland (Y/N) <sup>1</sup>	Hydric Soils (Y/N) <sup>1</sup>	Compaction Prone (Y/N) <sup>2</sup>	Highly Erodible		Revegetation Concerns (Y/N) <sup>5</sup>	Stony/Rocky (Y/N) <sup>6</sup>	Shallow to Bedrock (Y/N) <sup>7</sup>
								Water (Y/N) <sup>3</sup>	Wind (Y/N) <sup>4</sup>			
<b>24-Inch Pipeline (Continued)</b>												
<i>Jersey County, Illinois (Continued)</i>												
44.1	79B	Menfro	90	0.02	Y	N	N	N	N	N	N	N
44.1	79C2	Menfro	85	0.05	N	N	N	N	N	Y	N	N
44.2	833G	Goss, Menfro	60, 30	0.06	N	N	N	Y	N	Y	Y, N	N
44.2	79C2	Menfro	85	0.07	N	N	N	N	N	Y	N	N
44.3	833G	Goss, Menfro	60, 30	0.05	N	N	N	Y	N	Y	Y, N	N
44.4	79C2	Menfro	85	0.13	N	N	N	N	N	Y	N	N
44.6	833G	Goss, Menfro	60, 30	0.17	N	N	N	Y	N	Y	Y, N	N
44.6	79D2	Menfro	90	0.04	N	N	N	N	N	Y	N	N
44.7	833G	Goss, Menfro	60, 30	0.06	N	N	N	Y	N	Y	Y, N	N
44.7	79D2	Menfro	90	0.09	N	N	N	N	N	Y	N	N
44.9	833G	Goss, Menfro	60, 30	0.11	N	N	N	Y	N	Y	Y, N	N
44.9	3475A	Elsah	90	0.03	N	N	N	N	N	N	Y	N
44.9	837G	Lacrescent, Rock Outcrop	30, 70	0.01	N	N	N	Y	N	Y	Y	N
45.0	3475A	Elsah	90	0.14	N	N	N	N	N	N	Y	N
45.2	W	Water	N/A	0.26	N/A	N/A	N/A	N/A	N/A	N/A	N/A	N/A
<i>St. Charles County, Missouri</i>												
45.4	99001	Water	N/A	0.31	N/A	N/A	N/A	N/A	N/A	N/A	N/A	N/A
45.8	66066	Carlow	90	0.24	N	Y	N	N	N	N	N	N
45.9	99001	Water	N/A	0.07	N/A	N/A	N/A	N/A	N/A	N/A	N/A	N/A
46.0	66066	Carlow	90	0.08	N	Y	N	N	N	N	N	N
46.1	66100	Portage	85	0.06	N	Y	Y	N	N	N	N	N
46.3	66066	Carlow	90	0.26	N	Y	N	N	N	N	N	N
46.6	66100	Portage	85	0.80	N	Y	Y	N	N	N	N	N
47.3R	66066	Carlow	90	0.23	N	Y	N	N	N	N	N	N
47.4R	66100	Portage	85	0.08	N	Y	Y	N	N	N	N	N
47.6R	66066	Carlow	90	0.18	N	Y	N	N	N	N	N	N
47.7R	64016	Blase	95	0.03	Y	N	N	N	N	N	N	N





**Appendix 7-B. Soil Characteristics by MP Segment for Each Soil Map Unit along the Proposed Project (Continued)**

Nearest MP	Map Unit Symbol	Component Name	Component Percent	Crossing Length (miles)	Prime Farmland (Y/N) <sup>1</sup>	Hydric Soils (Y/N) <sup>1</sup>	Compaction Prone (Y/N) <sup>2</sup>	Highly Erodible		Revegetation Concerns (Y/N) <sup>5</sup>	Stony/Rocky (Y/N) <sup>6</sup>	Shallow to Bedrock (Y/N) <sup>7</sup>
								Water (Y/N) <sup>3</sup>	Wind (Y/N) <sup>4</sup>			
<b>24-Inch Pipeline (Continued)</b>												
<i>St. Charles County, Missouri (Continued)</i>												
47.7R	64024	DeSioux	95	0.02	Y	N	N	N	N	N	N	N
47.8R	64016	Blase	95	0.09	Y	N	N	N	N	N	N	N
47.8R	64024	DeSioux	95	0.08	Y	N	N	N	N	N	N	N
47.9R	64016	Blase	95	0.05	Y	N	N	N	N	N	N	N
48.0R	64024	DeSioux	95	0.09	Y	N	N	N	N	N	N	N
48.0R	66066	Carlow	90	0.05	N	Y	N	N	N	N	N	N
48.1R	64024	DeSioux	95	0.41	Y	N	N	N	N	N	N	N
48.5	66066	Carlow	90	0.02	N	Y	N	N	N	N	N	N
48.5	64016	Blase	95	0.07	Y	N	N	N	N	N	N	N
48.6	66066	Carlow	90	0.06	N	Y	N	N	N	N	N	N
48.6	64024	DeSioux	95	0.09	Y	N	N	N	N	N	N	N
49.0	66066	Carlow	90	0.50	N	Y	N	N	N	N	N	N
49.2	66100	Portage	85	0.04	N	Y	Y	N	N	N	N	N
49.3	64016	Blase	95	0.20	Y	N	N	N	N	N	N	N
49.5	66100	Portage	85	0.08	N	Y	Y	N	N	N	N	N
49.5	64016	Blase	95	0.16	Y	N	N	N	N	N	N	N
49.7	66100	Portage	85	0.30	N	Y	Y	N	N	N	N	N
50.0	66066	Carlow	90	0.06	N	Y	N	N	N	N	N	N
50.0	66100	Portage	85	0.05	N	Y	Y	N	N	N	N	N
50.1	66066	Carlow	90	0.03	N	Y	N	N	N	N	N	N
50.1	64016	Blase	95	0.07	Y	N	N	N	N	N	N	N
50.2	66100	Portage	85	0.02	N	Y	Y	N	N	N	N	N
50.2	66066	Carlow	90	0.00	N	Y	N	N	N	N	N	N
50.2	66100	Portage	85	0.03	N	Y	Y	N	N	N	N	N
50.3	64016	Blase	95	0.18	Y	N	N	N	N	N	N	N
50.4	64024	DeSioux	95	0.07	Y	N	N	N	N	N	N	N
50.6	66019	Lowmo	85	1.48	Y	N	N	N	N	N	N	N
52.0	66059	Peers	85	0.07	Y	N	N	N	N	N	N	N



**Appendix 7-B. Soil Characteristics by MP Segment for Each Soil Map Unit along the Proposed Project (Continued)**

Nearest MP	Map Unit Symbol	Component Name	Component Percent	Crossing Length (miles)	Prime Farmland (Y/N) <sup>1</sup>	Hydric Soils (Y/N) <sup>1</sup>	Compaction Prone (Y/N) <sup>2</sup>	Highly Erodible		Revegetation Concerns (Y/N) <sup>5</sup>	Stony/Rocky (Y/N) <sup>6</sup>	Shallow to Bedrock (Y/N) <sup>7</sup>
								Water (Y/N) <sup>3</sup>	Wind (Y/N) <sup>4</sup>			
<b>24-Inch Pipeline (Continued)</b>												
<i>St. Charles County, Missouri (Continued)</i>												
52.1	66019	Lowmo	85	0.11	Y	N	N	N	N	N	N	N
52.7	66059	Peers	85	0.68	Y	N	N	N	N	N	N	N
54.2	66110	SansDessein	90	1.48	N	Y	Y	N	N	N	N	N
54.4	66019	Lowmo	85	0.21	Y	N	N	N	N	N	N	N
54.6	66110	SansDessein	90	0.29	N	Y	Y	N	N	N	N	N
55.1	66019	Lowmo	85	0.38	Y	N	N	N	N	N	N	N
55.2	66110	SansDessein	90	0.20	N	Y	Y	N	N	N	N	N
55.4	13598	Booker	95	0.03	N	Y	Y	N	N	N	N	N
55.6	66110	SansDessein	90	0.39	N	Y	Y	N	N	N	N	N
55.8	13598	Booker	95	0.05	N	Y	Y	N	N	N	N	N
56.0	66019	Lowmo	85	0.79	Y	N	N	N	N	N	N	N
56.6	36023	Landes	90	0.02	Y	N	N	N	N	Y	N	N
56.7	66019	Lowmo	85	0.05	Y	N	N	N	N	N	N	N
56.7	36023	Landes	90	0.04	Y	N	N	N	N	Y	N	N
56.7	66059	Peers	85	0.02	Y	N	N	N	N	N	N	N
56.8	66019	Lowmo	85	0.03	Y	N	N	N	N	N	N	N
56.8	66059	Peers	85	0.10	Y	N	N	N	N	N	N	N
56.9	66019	Lowmo	85	0.11	Y	N	N	N	N	N	N	N
57.0	66059	Peers	85	0.02	Y	N	N	N	N	N	N	N
57.0	66019	Lowmo	85	0.02	Y	N	N	N	N	N	N	N
57.0	66059	Peers	85	0.04	Y	N	N	N	N	N	N	N
57.1	66019	Lowmo	85	0.05	Y	N	N	N	N	N	N	N
57.1	66059	Peers	85	0.05	Y	N	N	N	N	N	N	N
57.2	66019	Lowmo	85	0.03	Y	N	N	N	N	N	N	N
57.2	66059	Peers	85	0.03	Y	N	N	N	N	N	N	N
57.2	66019	Lowmo	85	0.06	Y	N	N	N	N	N	N	N
57.4	66059	Peers	85	0.29	Y	N	N	N	N	N	N	N
57.6	66019	Lowmo	85	0.03	Y	N	N	N	N	N	N	N



**Appendix 7-B. Soil Characteristics by MP Segment for Each Soil Map Unit along the Proposed Project (Continued)**

Nearest MP	Map Unit Symbol	Component Name	Component Percent	Crossing Length (miles)	Prime Farmland (Y/N) <sup>1</sup>	Hydric Soils (Y/N) <sup>1</sup>	Compaction Prone (Y/N) <sup>2</sup>	Highly Erodible		Revegetation Concerns (Y/N) <sup>5</sup>	Stony/Rocky (Y/N) <sup>6</sup>	Shallow to Bedrock (Y/N) <sup>7</sup>
								Water (Y/N) <sup>3</sup>	Wind (Y/N) <sup>4</sup>			
<b>24-Inch Pipeline (Continued)</b>												
<i>St. Charles County, Missouri (Continued)</i>												
57.6	66059	Peers	85	0.10	Y	N	N	N	N	N	N	N
57.7	66019	Lowmo	85	0.02	Y	N	N	N	N	N	N	N
57.7	66059	Peers	85	0.03	Y	N	N	N	N	N	N	N
57.8	66019	Lowmo	85	0.04	Y	N	N	N	N	N	N	N
57.8	66059	Peers	85	0.01	Y	N	N	N	N	N	N	N
57.8	66012	Blake	85	0.06	N	Y	N	N	N	N	N	N
57.9	99001	Water	N/A	0.07	N/A	N/A	N/A	N/A	N/A	N/A	N/A	N/A
58.0	66126	Haynie, Treloar, Blake	45, 25, 20	0.06	N	Y	N	N	N	N, Y, N	N	N
58.0	99001	Water	N/A	0.10	N/A	N/A	N/A	N/A	N/A	N/A	N/A	N/A
<i>St. Louis County, Missouri</i>												
58.2	99001	Water	N/A	0.14	N/A	N/A	N/A	N/A	N/A	N/A	N/A	N/A
58.4	99000	Pits, quarry	N/A	0.37	N/A	N/A	N/A	N/A	N/A	N/A	N/A	N/A
58.81	60001	Menfro	100	0.20	N	N	N	N	N	Y	N	N
<b>North County Extension</b>												
<i>St. Louis County, Missouri</i>												
0.0	60171	Menfro, karst <sup>8</sup>	90	0.01	N	N	N	N	N	Y	N	N
0.0	60001	Menfro	100	0.04	N	N	N	N	N	Y	N	N
0.1	60003	Menfro	85	0.05	N	N	N	Y	N	Y	N	N
0.1	60001	Menfro	100	0.06	N	N	N	N	N	Y	N	N
0.2	60003	Menfro	85	0.04	N	N	N	Y	N	Y	N	N
0.2	66024	Wilbur	90	0.07	N	N	N	N	N	N	N	N
0.3	60003	Menfro	85	0.04	N	N	N	Y	N	Y	N	N
0.4	60001	Menfro	100	0.08	N	N	N	N	N	Y	N	N
0.4	60003	Menfro	85	0.05	N	N	N	Y	N	Y	N	N
0.5	66024	Wilbur	90	0.11	N	N	N	N	N	N	N	N
0.6	60003	Menfro	85	0.11	N	N	N	Y	N	Y	N	N
0.8	60165	Menfro	100	0.15	Y	N	N	N	N	N	N	N



**Appendix 7-B. Soil Characteristics by MP Segment for Each Soil Map Unit along the Proposed Project (Continued)**

Nearest MP	Map Unit Symbol	Component Name	Component Percent	Crossing Length (miles)	Prime Farmland (Y/N) <sup>1</sup>	Hydric Soils (Y/N) <sup>1</sup>	Compaction Prone (Y/N) <sup>2</sup>	Highly Erodible		Revegetation Concerns (Y/N) <sup>5</sup>	Stony/Rocky (Y/N) <sup>6</sup>	Shallow to Bedrock (Y/N) <sup>7</sup>
								Water (Y/N) <sup>3</sup>	Wind (Y/N) <sup>4</sup>			
<b>North County Extension (Continued)</b>												
<i>St. Louis County, Missouri (Continued)</i>												
0.8	60001	Menfro	100	0.06	N	N	N	N	N	Y	N	N
0.9	60003	Menfro	85	0.06	N	N	N	Y	N	Y	N	N
1.0	60165	Menfro	100	0.03	Y	N	N	N	N	N	N	N
1.0	60003	Menfro	85	0.01	N	N	N	Y	N	Y	N	N
1.0	60165	Menfro	100	0.00	Y	N	N	N	N	N	N	N
1.2	60003	Menfro	85	0.46	N	N	N	Y	N	Y	N	N
1.6	60004	Menfro	90	0.22	N	N	N	Y	N	Y	N	N
1.7	60025	Harvester, Urban Land	40, 50	0.11	N	N	N	N	N	Y	N	N
1.8	60223	Harvester, Urban Land	40, 50	0.05	N	N	N	N	N	Y	N	N
2.1	60005	Menfro	89	0.35	N	N	N	Y	N	Y	N	N
2.2	60003	Menfro	85	0.17	N	N	N	Y	N	Y	N	N
2.4	66024	Wilbur	90	0.11	N	N	N	N	N	N	N	N
2.8	60001	Menfro	100	0.41	N	N	N	N	N	Y	N	N
2.9	66024	Wilbur	90	0.14	N	N	N	N	N	N	N	N
3.3	60003	Menfro	85	0.32	N	N	N	Y	N	Y	N	N
3.4	60025	Harvester, Urban Land	40, 50	0.08	N	N	N	N	N	Y	N	N
3.4	60003	Menfro	85	0.03	N	N	N	Y	N	Y	N	N
3.4	66024	Wilbur	90	0.04	N	N	N	N	N	N	N	N
3.5	60003	Menfro	85	0.11	N	N	N	Y	N	Y	N	N
3.6	60001	Menfro	100	0.18	N	N	N	N	N	Y	N	N
3.8	66024	Wilbur	90	0.06	N	N	N	N	N	N	N	N
3.8	60004	Menfro	90	0.03	N	N	N	Y	N	Y	N	N
3.9	60001	Menfro	100	0.07	N	N	N	N	N	Y	N	N
4.0	60004	Menfro	90	0.08	N	N	N	Y	N	Y	N	N
4.0	99001	Water	N/A	0.04	N/A	N/A	N/A	N/A	N/A	N/A	N/A	N/A
4.1	60004	Menfro	90	0.04	N	N	N	Y	N	Y	N	N



**Appendix 7-B. Soil Characteristics by MP Segment for Each Soil Map Unit along the Proposed Project (Continued)**

Nearest MP	Map Unit Symbol	Component Name	Component Percent	Crossing Length (miles)	Prime Farmland (Y/N) <sup>1</sup>	Hydric Soils (Y/N) <sup>1</sup>	Compaction Prone (Y/N) <sup>2</sup>	Highly Erodible		Revegetation Concerns (Y/N) <sup>5</sup>	Stony/Rocky (Y/N) <sup>6</sup>	Shallow to Bedrock (Y/N) <sup>7</sup>
								Water (Y/N) <sup>3</sup>	Wind (Y/N) <sup>4</sup>			
<b>North County Extension (Continued)</b>												
<i>St. Louis County, Missouri (Continued)</i>												
4.1	99001	Water	N/A	0.07	N/A	N/A	N/A	N/A	N/A	N/A	N/A	N/A
4.3	60176	Menfro, karst <sup>8</sup>	85	0.15	N	N	N	Y	N	Y	N	N
4.3	99001	Water	N/A	0.05	N/A	N/A	N/A	N/A	N/A	N/A	N/A	N/A
4.4	60176	Menfro, karst <sup>8</sup>	85	0.07	N	N	N	Y	N	Y	N	N
4.7	60025	Harvester, Urban Land	40, 50	0.28	N	N	N	N	N	Y	N	N
4.7	60001	Menfro	100	0.07	N	N	N	N	N	Y	N	N
4.9	60165	Menfro	100	0.26	Y	N	N	N	N	N	N	N
5.1	60003	Menfro	85	0.11	N	N	N	Y	N	Y	N	N
5.2	60005	Menfro	89	0.02	N	N	N	Y	N	Y	N	N
5.2	60165	Menfro	100	0.07	Y	N	N	N	N	N	N	N
5.3	60005	Menfro	89	0.11	N	N	N	Y	N	Y	N	N
5.4	60003	Menfro	85	0.06	N	N	N	Y	N	Y	N	N
5.5	60005	Menfro	89	0.16	N	N	N	Y	N	Y	N	N
5.8	60165	Menfro	100	0.27	Y	N	N	N	N	N	N	N
5.9	60003	Menfro	85	0.17	N	N	N	Y	N	Y	N	N
6.0	60165	Menfro	100	0.02	Y	N	N	N	N	N	N	N
<b>Cathodic Protection (24-Inch Pipeline)</b>												
<i>Greene County, Illinois</i>												
Remote Groundbed 1												
-	257B	Clarksdale	90	-	Y	N	N	N	N	N	N	N
-	279B	Rozetta	90	-	Y	N	N	N	N	N	N	N
Remote Groundbed 2												
-	51A											
-	257B	Clarksdale	90	-	Y	N	N	N	N	N	N	N
Remote Groundbed 3												
-	51B	Muscature	90	-	Y	N	N	N	N	N	N	N
-	675B	Greenbush	90	-	Y	N	N	N	N	N	N	N



**Appendix 7-B. Soil Characteristics by MP Segment for Each Soil Map Unit along the Proposed Project (Continued)**

Nearest MP	Map Unit Symbol	Component Name	Component Percent	Crossing Length (miles)	Prime Farmland (Y/N) <sup>1</sup>	Hydric Soils (Y/N) <sup>1</sup>	Compaction Prone (Y/N) <sup>2</sup>	Highly Erodible		Revegetation Concerns (Y/N) <sup>5</sup>	Stony/Rocky (Y/N) <sup>6</sup>	Shallow to Bedrock (Y/N) <sup>7</sup>
								Water (Y/N) <sup>3</sup>	Wind (Y/N) <sup>4</sup>			
<b>Cathodic Protection (24-Inch Pipeline) (Continued)</b>												
<i>Jersey County, Illinois</i>												
Remote Groundbed 4												
-	61A	Atterberry	98	-	N	N	N	N	N	N	N	N
-	279C2	Rozetta	94	-	N	N	N	N	N	Y	N	N
-	279B	Rozetta	90	-	Y	N	N	N	N	N	N	N
<i>St. Charles County, Illinois</i>												
Remote Groundbed 5												
-	66019	Lowmo	85	-	Y	N	N	N	N	N	N	N
<b>Cathodic Protection (North County Extension)</b>												
<i>St. Louis County, Illinois</i>												
Remote Groundbed 1												
-	60001	Menfro	100	-	N	N	N	N	N	Y	N	N
-	60003	Menfro	85	-	N	N	N	Y	N	Y	N	N
-	60165	Menfro	100	-	Y	N	N	N	N	N	N	N
<b>Aboveground Facilities</b>												
<i>Scott County, Illinois</i>												
REX Receipt Station												
-	279B	Rozetta	90	-	Y	N	N	N	N	N	N	N
-	279C3	Rozetta	94	-	N	N	N	Y	N	Y	N	N
<i>St. Louis County, Missouri</i>												
Laclede/Lange Delivery Station												
-	60001	Menfro	100	-	N	N	N	N	N	Y	N	N
-	60171	Menfro, karst <sup>8</sup>	90	-	N	N	N	N	N	Y	N	N
Chain of Rocks Station												
-	13598	Booker	95	-	N	Y	Y	N	N	N	N	N
-	60003	Menfro	85	-	N	N	N	Y	N	Y	N	N
-	60165	Menfro	100	-	Y	N	N	N	N	N	N	N



**Appendix 7-B. Soil Characteristics by MP Segment for Each Soil Map Unit along the Proposed Project (Continued)**

Nearest MP	Map Unit Symbol	Component Name	Component Percent	Crossing Length (miles)	Prime Farmland (Y/N) <sup>1</sup>	Hydric Soils (Y/N) <sup>1</sup>	Compaction Prone (Y/N) <sup>2</sup>	Highly Erodible		Revegetation Concerns (Y/N) <sup>5</sup>	Stony/Rocky (Y/N) <sup>6</sup>	Shallow to Bedrock (Y/N) <sup>7</sup>
								Water (Y/N) <sup>3</sup>	Wind (Y/N) <sup>4</sup>			
<b>Staging Areas</b>												
<i>Scott County, Illinois</i>												
SA-001												
-	17A	Keomah	90	-	N	N	N	N	N	N	N	N
-	257A	Clarksdale	90	-	N	N	N	N	N	N	N	N
-	279B	Rozetta	90	-	Y	N	N	N	N	N	N	N
-	279C3	Rozetta	94	-	N	N	N	Y	N	Y	N	N
<i>Jersey County, Illinois</i>												
SA-002												
-	79C2	Menfro	85	-	N	N	N	N	N	Y	N	N
-	477B	Winfield	95	-	Y	N	N	N	N	N	N	N
SA-003												
-	79C2	Menfro	85	-	N	N	N	N	N	Y	N	N
-	477B	Winfield	95	-	Y	N	N	N	N	N	N	N
<i>St. Charles County, Missouri</i>												
SA-004												
-	66100	Portage	85	-	N	Y	Y	N	N	N	N	N
SA-005												
-	66019	Lowmo	85	-	Y	N	N	N	N	N	N	N
-	66059	Peers	85	-	Y	N	N	N	N	N	N	N
<b>Access Roads</b>												
<i>Scott County, Illinois</i>												
PAR-001												
-	279B	Rozetta	90	0.03	Y	N	N	N	N	N	N	N
-	279C3	Rozetta	94	0.00	N	N	N	Y	N	Y	N	N
TAR-003												
-	43A	Ipava	85	0.07	Y	N	N	N	N	N	N	N
-	257A	Clarksdale	90	0.12	N	N	N	N	N	N	N	N
-	279B	Rozetta	90	0.02	Y	N	N	N	N	N	N	N



**Appendix 7-B. Soil Characteristics by MP Segment for Each Soil Map Unit along the Proposed Project (Continued)**

Nearest MP	Map Unit Symbol	Component Name	Component Percent	Crossing Length (miles)	Prime Farmland (Y/N) <sup>1</sup>	Hydric Soils (Y/N) <sup>1</sup>	Compaction Prone (Y/N) <sup>2</sup>	Highly Erodible		Revegetation Concerns (Y/N) <sup>5</sup>	Stony/Rocky (Y/N) <sup>6</sup>	Shallow to Bedrock (Y/N) <sup>7</sup>
								Water (Y/N) <sup>3</sup>	Wind (Y/N) <sup>4</sup>			
<b>Access Roads (Continued)</b>												
<i>Greene County, Illinois</i>												
TAR-008												
-	279B	Rozetta	90	0.01	Y	N	N	N	N	N	N	N
TAR-009												
-	675C2	Greenbush	95	0.19	N	N	N	N	N	Y	N	N
TAR-010												
-	675B	Greenbush	90	0.05	Y	N	N	N	N	N	N	N
-	675C2	Greenbush	95	0.04	N	N	N	N	N	Y	N	N
TAR-012												
-	280B	Fayette	97	0.25	Y	N	N	N	N	N	N	N
-	8D2	Hickory	90	0.17	N	N	N	N	N	Y	N	N
-	3331A	Haymond	90	0.05	N	N	N	N	N	N	N	N
-	134C2	Camden	97	0.05	N	N	N	N	N	Y	N	N
TAR-013												
-	3451A	Lawson	90	0.31	N	N	N	N	N	N	N	N
TAR-014												
-	675C2	Greenbush	95	0.05	N	N	N	N	N	Y	N	N
-	280D2	Fayette	95	0.19	N	N	N	N	N	Y	N	N
-	675B	Greenbush	90	0.02	Y	N	N	N	N	N	N	N
<i>Jersey County, Illinois</i>												
PAR-024												
-	119C2	Elco	97	0.01	N	N	N	N	N	Y	N	N
TAR-015												
-	3634A	Blyton	90	0.13	N	N	N	N	N	N	N	N
TAR-016												
-	280D3	Fayette	95	0.04	N	N	N	Y	N	Y	N	N
-	280C2	Fayette	95	0.04	N	N	N	N	N	Y	N	N
-	280B	Fayette	90	0.05	Y	N	N	N	N	N	N	N
-	279C2	Rozetta	94	0.11	N	N	N	N	N	Y	N	N





**Appendix 7-B. Soil Characteristics by MP Segment for Each Soil Map Unit along the Proposed Project (Continued)**

Nearest MP	Map Unit Symbol	Component Name	Component Percent	Crossing Length (miles)	Prime Farmland (Y/N) <sup>1</sup>	Hydric Soils (Y/N) <sup>1</sup>	Compaction Prone (Y/N) <sup>2</sup>	Highly Erodible		Revegetation Concerns (Y/N) <sup>5</sup>	Stony/Rocky (Y/N) <sup>6</sup>	Shallow to Bedrock (Y/N) <sup>7</sup>
								Water (Y/N) <sup>3</sup>	Wind (Y/N) <sup>4</sup>			
<b>Access Roads (Continued)</b>												
<i>Jersey County, Illinois (Continued)</i>												
-	675B	Greenbush	90	0.13	Y	N	N	N	N	N	N	N
-	61A	Atterberry	98	0.03	N	N	N	N	N	N	N	N
TAR-017												
-	79B	Menfro	90	0.15	Y	N	N	N	N	N	N	N
-	79C2	Menfro	85	0.62	N	N	N	N	N	Y	N	N
-	833G	Goss, Menfro	60, 30	0.03	N	N	N	Y	N	Y	Y, N	N
-	79D2	Menfro	90	0.15	N	N	N	N	N	Y	N	N
-	833G	Goss, Menfro	60, 30	0.01	N	N	N	Y	N	Y	Y, N	N
<i>St. Charles County, Missouri</i>												
PAR-018												
-	66066	Carlow	90	0.68	N	Y	N	N	N	N	N	N
-	66100	Portage	85	0.10	N	Y	Y	N	N	N	N	N
TAR-022												
-	66019	Lowmo	85	0.14	Y	N	N	N	N	N	N	N
TAR-019												
-	66059	Peers	85	0.12	Y	N	N	N	N	N	N	N
<i>St. Louis County, Missouri</i>												
TAR-021												
-	99000	Pits, quarry	N/A	0.61	N/A	N/A	N/A	N/A	N/A	N/A	N/A	N/A
-	99000	Pits, quarry	N/A	0.10	N/A	N/A	N/A	N/A	N/A	N/A	N/A	N/A
TAR-023												
-	60004	Menfro	90	0.004	N	N	N	Y	N	Y	N	N
-	60025	Harvester, Urban Land	40, 50	0.004	N	N	N	N	N	Y	N	N
TAR-025												
-	60003	Menfro	85	0.05	N	N	N	Y	N	Y	N	N
-	66024	Wilbur	90	0.07	N	N	N	N	N	N	N	N



**Appendix 7-B. Soil Characteristics by MP Segment for Each Soil Map Unit along the Proposed Project (Continued)**

Nearest MP	Map Unit Symbol	Component Name	Component Percent	Crossing Length (miles)	Prime Farmland (Y/N) <sup>1</sup>	Hydric Soils (Y/N) <sup>1</sup>	Compaction Prone (Y/N) <sup>2</sup>	Highly Erodible		Revegetation Concerns (Y/N) <sup>5</sup>	Stony/Rocky (Y/N) <sup>6</sup>	Shallow to Bedrock (Y/N) <sup>7</sup>
								Water (Y/N) <sup>3</sup>	Wind (Y/N) <sup>4</sup>			
<b>Access Roads (Continued)</b>												
<i>St. Louis County, Missouri (Continued)</i>												
TAR-026												
-	60025	Harvester, Urban Land	40, 50	0.26	N	N	N	N	N	Y	N	N

Notes:

- <sup>1</sup> As designated by the Natural Resources Conservation Service. Prime farmland includes soils where all areas are Prime Farmland (no land improvements). Y = Yes; N = No.
- <sup>2</sup> Includes soils that have clay loam or finer textures in somewhat poor, poor, and very poor drainage classes.
- <sup>3</sup> Includes land in capability subclasses 4E through 8E and soils with an average slope greater than or equal to nine percent.
- <sup>4</sup> Includes soils with Wind Erodibility Group classification of one or two.
- <sup>5</sup> Includes coarse-textured soils (sandy loams and coarser) that are moderately well to excessively well drained and soils with an average slope greater than or equal to nine percent.
- <sup>6</sup> Includes soils that have a very gravelly, extremely gravelly, cobbly, stony, bouldery, flaggy, or channery modifier to the textural class.
- <sup>7</sup> Includes soils that have bedrock within 60 inches of the soil surface.
- <sup>8</sup> The state resources described in Resource Report 6 describe MP 4.3 - MP 4.4 on the North County Extension as a sink area; these areas will be crossed by horizontal directional drill and planned mitigation includes maintaining rates of recharge and discharge in the subsurface at the desired natural levels. Karst soils at Laclede/Lange Delivery Station may be associated with the sinkholes reported at MP 58.8. As discussed in Resource Report 6, no sinkhole features are anticipated to be crossed at the site.



## Appendix 7-B Soil Descriptions

### 7-B.1 Illinois

#### **Hickory silt loam, 10 to 18 percent slopes (8D)**

The Hickory component makes up 90 percent of the map unit. Slopes are 10 to 18 percent. This component is on ground moraines, till plains. The parent material consists of loamy till. Depth to a root restrictive layer is greater than 60 inches. The natural drainage class is well drained. Water movement in the most restrictive layer is moderately high. Available water to a depth of 60 inches is high. Shrink-swell potential is low. This soil is not flooded. It is not ponded. There is no zone of water saturation within a depth of 72 inches. Organic matter content in the surface horizon is about four percent. Non-irrigated land capability classification is 3e. This soil does not meet hydric criteria. There are no saline horizons within 30 inches of the soil surface.

The Atlas soil, Marseilles soil and Radford soil are minor components.

The Ava component makes up 90 percent of the map unit. Slopes are two to five percent. This component is on convex ridges on loess covered till plains. The parent material consists of loess over mixed loess and drift over till. Depth to a root restrictive layer, fragipan, is 25 to 40 inches. The natural drainage class is moderately well drained. Water movement in the most restrictive layer is moderately low. Available water to a depth of 60 inches is moderate. Shrink-swell potential is low. This soil is not flooded. It is not ponded. A seasonal zone of water saturation is at 27 inches during January, February, March, April. Organic matter content in the surface horizon is about two percent. Non-irrigated land capability classification is 2e. This soil does not meet hydric criteria. There are no saline horizons within 30 inches of the soil surface.

The Frondorf soil and Rozetta soil are minor components.

#### **Hickory silt loam, 10 to 18 percent slopes, eroded (8D2)**

The Hickory component makes up 90 percent of the map unit. Slopes are 10 to 18 percent. This component is on ground moraines, till plains. The parent material consists of Illinois till. Depth to a root restrictive layer is greater than 60 inches. The natural drainage class is well drained. Water movement in the most restrictive layer is moderately high. Available water to a depth of 60 inches (or restricted depth) is high. Shrink-swell potential is low. This soil is not flooded. It is not ponded. There is no zone of water saturation within a depth of 72 inches. Organic matter content in the surface horizon is about two percent. Non-irrigated land capability classification is 3e. This soil does not meet hydric criteria. There are no saline horizons within 30 inches of the soil surface.

The Marseilles soil, Rozetta soil, Wakeland soil and Ava soil are minor components. Hickory silt loam, 18 to 25 percent slopes, eroded (8E2)



### **Hickory clay loam, 10 to 18 percent slopes, severely eroded (8D3)**

The Hickory component makes up 90 percent of the map unit. Slopes are 10 to 18 percent. This component is on ground moraines on till plains. The parent material consists of Illinois till. Depth to a root restrictive layer is greater than 60 inches. The natural drainage class is well drained. Water movement in the most restrictive layer is moderately high. Available water to a depth of 60 inches (or restricted depth) is high. Shrink-swell potential is low. This soil is not flooded. It is not ponded. There is no zone of water saturation within a depth of 72 inches. Organic matter content in the surface horizon is about one percent. Nonirrigated land capability classification is 4e. This soil does not meet hydric criteria. There are no saline horizons within 30 inches of the soil surface.

### **Hickory silt loam, 18 to 25 percent slopes, eroded (8E2)**

The Hickory component makes up 90 percent of the map unit. Slopes are 18 to 25 percent. This component is on ground moraines, till plains. The parent material consists of Illinois till. Depth to a root restrictive layer is greater than 60 inches. The natural drainage class is well drained. Water movement in the most restrictive layer is moderately high. Available water to a depth of 60 inches (or restricted depth) is high. Shrink-swell potential is low. This soil is not flooded. It is not ponded. There is no zone of water saturation within a depth of 72 inches. Organic matter content in the surface horizon is about two percent. Non-irrigated land capability classification is 6e. This soil does not meet hydric criteria. There are no saline horizons within 30 inches of the soil surface.

The Atlas soil, Marseilles soil, Wakeland soil and Rozetta soil are minor components.

### **Hickory silt loam, 18 to 35 percent slopes (8F)**

The Hickory component makes up 89 percent of the map unit. Slopes are 18 to 35 percent. This component is on till plains, ground moraines. The parent material consists of loamy till. Depth to a root restrictive layer is greater than 60 inches. The natural drainage class is well drained. Water movement in the most restrictive layer is moderately high. Available water to a depth of 60 inches is high. Shrink-swell potential is low. This soil is not flooded. It is not ponded. There is no zone of water saturation within a depth of 72 inches. Organic matter content in the surface horizon is about four percent. Non-irrigated land capability classification is 6e. This soil does not meet hydric criteria. There are no saline horizons within 30 inches of the soil surface.

The Radford soil, Marseilles soil, Atlas soil, Fayette soil, and Frondorf soil are minor components.

The Ava component makes up 90 percent of the map unit. Slopes are two to five percent. This component is on convex ridges on loess covered till plains. The parent material consists of loess over mixed loess and drift over till. Depth to a root restrictive layer, fragipan, is 25 to 40 inches. The natural drainage class is moderately well drained. Water movement in the most restrictive layer is moderately low. Available water to a depth of 60 inches is moderate. Shrink-swell potential is low. This soil is not flooded. It is not ponded. A seasonal zone of water saturation is at 27 inches during January, February, March, April. Organic matter



content in the surface horizon is about two percent. Non-irrigated land capability classification is 2e. This soil does not meet hydric criteria. There are no saline horizons within 30 inches of the soil surface.

The Wakeland soil is a minor component.

**Hickory silt loam, 18 to 35 percent slopes, eroded (8F2)**

The Hickory component makes up 90 percent of the map unit. Slopes are 18 to 35 percent. This component is on ground moraines, till plains. The parent material consists of Illinois till. Depth to a root restrictive layer is greater than 60 inches. The natural drainage class is well drained. Water movement in the most restrictive layer is moderately high. Available water to a depth of 60 inches (or restricted depth) is high. Shrink-swell potential is low. This soil is not flooded. It is not ponded. There is no zone of water saturation within a depth of 72 inches. Organic matter content in the surface horizon is about two percent. Non-irrigated land capability classification is 6e. This soil does not meet hydric criteria. There are no saline horizons within 30 inches of the soil surface.

The Atlas soil, Rozetta soil, Ava soil and Wakeland soil are minor components.

**Hickory silt loam, 35 to 60 percent slopes (8G)**

The Hickory component makes up 90 percent of the map unit. Slopes are 35 to 60 percent. This component is on ground moraines, till plains. The parent material consists of loamy till. Depth to a root restrictive layer is greater than 60 inches. The natural drainage class is well drained. Water movement in the most restrictive layer is moderately high. Available water to a depth of 60 inches is high. Shrink-swell potential is low. This soil is not flooded. It is not ponded. There is no zone of water saturation within a depth of 72 inches. Organic matter content in the surface horizon is about four percent. Non-irrigated land capability classification is 7e. This soil does not meet hydric criteria. There are no saline horizons within 30 inches of the soil surface.

The Marseilles soil, Atlas soil, Wakeland soil, and Radford soils are minor components.

The Ava component makes up 90 percent of the map unit. Slopes are two to five percent. This component is on convex ridges on loess covered till plains. The parent material consists of loess over mixed loess and drift over till. Depth to a root restrictive layer, fragipan, is 25 to 40 inches. The natural drainage class is moderately well drained. Water movement in the most restrictive layer is moderately low. Available water to a depth of 60 inches is moderate. Shrink-swell potential is low. This soil is not flooded. It is not ponded. A seasonal zone of water saturation is at 27 inches during January, February, March, and April. Organic matter content in the surface horizon is about two percent. Non-irrigated land capability classification is 2e. This soil does not meet hydric criteria. There are no saline horizons within 30 inches of the soil surface.

The Frondorf soil and Fayette soil are minor components.



### **Rushville silt loam, zero to two percent slopes (16A)**

The Rushville component makes up 90 percent of the map unit. Slopes are zero to two percent. This component is on depressions on ground moraines. The parent material consists of loess. Depth to a root restrictive layer, abrupt textural change, is nine to 19 inches. The natural drainage class is poorly drained. Water movement in the most restrictive layer is low. Available water to a depth of 60 inches is high. Shrink-swell potential is moderate. This soil is not flooded. It is frequently ponded. A seasonal zone of water saturation is at six inches during January, February, March, April, and May. Organic matter content in the surface horizon is about two percent. Non-irrigated land capability classification is 3w. This soil meets hydric criteria.

### **Keomah silt loam, zero to two percent slopes (17A)**

The Keomah component makes up 90 percent of the map unit. Slopes are zero to two percent. This component is on ground moraines, till plains. The parent material consists of loess. Depth to a root restrictive layer is greater than 60 inches. The natural drainage class is somewhat poorly drained. Water movement in the most restrictive layer is moderately low. Available water to a depth of 60 inches is high. Shrink-swell potential is moderate. This soil is not flooded. It is not ponded. A seasonal zone of water saturation is at 15 inches during January, February, March, April, and May. Organic matter content in the surface horizon is about two percent. Non-irrigated land capability classification is 2w. This soil does not meet hydric criteria. There are no saline horizons within 30 inches of the soil surface.

The Rozetta soil, Denny soil and Rushville soil are minor components.

### **Sylvan silty clay loam, five to 10 percent slopes, severely eroded (19C3)**

The Sylvan component makes up 100 percent of the map unit. Slopes are five to 10 percent. This component is on ground moraines. The parent material consists of loess. Depth to a root restrictive layer is greater than 60 inches. The natural drainage class is well drained. Water movement in the most restrictive layer is moderately high. Available water to a depth of 60 inches is very high. Shrink-swell potential is low. This soil is not flooded. It is not ponded. There is no zone of water saturation within a depth of 72 inches. Organic matter content in the surface horizon is about one percent. Non-irrigated land capability classification is 4e. This soil does not meet hydric criteria. The calcium carbonate equivalent within 40 inches, typically, does not exceed 18 percent.

### **Ipava silt loam, zero to two percent slopes (43A)**

The Ipava component makes up 85 percent of the map unit. Slopes are zero to two percent. This component is on till plains, broad ground moraines. The parent material consists of loess. Depth to a root restrictive layer is greater than 60 inches. The natural drainage class is somewhat poorly drained. Water movement in the most restrictive layer is moderately high. Available water to a depth of 60 inches is high. Shrink-swell potential is moderate. This soil is not flooded. It is not ponded. A seasonal zone of water saturation is at 18 inches during January, February, March, April, and May. Organic matter content in the surface horizon is about four percent. Non-irrigated land capability classification is 1. This soil does not meet hydric criteria. There are no saline horizons within 30 inches of the soil surface.



The Virden component makes up 90 percent of the map unit. Slopes are zero to two percent. This component is on till plains, ground moraines. The parent material consists of loess. Depth to a root restrictive layer is greater than 60 inches. The natural drainage class is poorly drained. Water movement in the most restrictive layer is moderately high. Available water to a depth of 60 inches (or restricted depth) is high. Shrink-swell potential is high. This soil is not flooded. It is frequently ponded. A seasonal zone of water saturation is at six inches during January, February, March, April, and May. Organic matter content in the surface horizon is about five percent. Non-irrigated land capability classification is 2w. This soil meets hydric criteria. There are no saline horizons within 30 inches of the soil surface.

The Sable component makes up 85 percent of the map unit. Slopes are zero to two percent. This component is on till plains, swales. The parent material consists of loess. Depth to a root restrictive layer is greater than 60 inches. The natural drainage class is poorly drained. Water movement in the most restrictive layer is moderately high. Available water to a depth of 60 inches (or restricted depth) is high. Shrink-swell potential is moderate. This soil is not flooded. It is frequently ponded. A seasonal zone of water saturation is at 6 inches during January, February, March, April, and May. Organic matter content in the surface horizon is about five percent. Non-irrigated land capability classification is 2w. This soil meets hydric criteria. There are no saline horizons within 30 inches of the soil surface.

The Denny component makes up 95 percent of the map unit. Slopes are zero to two percent. This component is on depressions, till plains. The parent material consists of loess. Depth to a root restrictive layer, abrupt textural change, is 13 to 22 inches. The natural drainage class is poorly drained. Water movement in the most restrictive layer is moderately low. Available water to a depth of 60 inches is high. Shrink-swell potential is moderate. This soil is not flooded. It is frequently ponded. A seasonal zone of water saturation is at six inches during January, February, March, April, and May. Organic matter content in the surface horizon is about three percent. Non-irrigated land capability classification is 3w. This soil meets hydric criteria. There are no saline horizons within 30 inches of the soil surface.

#### **Denny silt loam, zero to two percent slope (45A)**

The Denny component makes up 95 percent of the map unit. Slopes are zero to two percent. This component is on depressions, till plains. The parent material consists of loess. Depth to a root restrictive layer, abrupt textural change, is 13 to 22 inches. The natural drainage class is poorly drained. Water movement in the most restrictive layer is moderately low. Available water to a depth of 60 inches is high. Shrink-swell potential is moderate. This soil is not flooded. It is frequently ponded. A seasonal zone of water saturation is at six inches during January, February, March, April, and May. Organic matter content in the surface horizon is about three percent. Non-irrigated land capability classification is 3w. This soil meets hydric criteria. There are no saline horizons within 30 inches of the soil surface.

The Buckhart soil is a minor component.



#### **Virden silt loam, zero to two percent slopes (47A)**

The Virden component makes up 90 percent of the map unit. Slopes are zero to two percent. This component is on till plains, ground moraines. The parent material consists of loess. Depth to a root restrictive layer is greater than 60 inches. The natural drainage class is poorly drained. Water movement in the most restrictive layer is moderately high. Available water to a depth of 60 inches (or restricted depth) is high. Shrink-swell potential is high. This soil is not flooded. It is frequently ponded. A seasonal zone of water saturation is at six inches during January, February, March, April, and May. Organic matter content in the surface horizon is about five percent. Non-irrigated land capability classification is 2w. This soil meets hydric criteria. There are no saline horizons within 30 inches of the soil surface.

The Ipava soil, Herrick soil and Piasa soil are minor components.

#### **Virden silty clay loam, zero to two percent slopes (50A)**

The Virden component makes up 90 percent of the map unit. Slopes are zero to two percent. This component is on till plains, ground moraines. The parent material consists of loess. Depth to a root restrictive layer is greater than 60 inches. The natural drainage class is poorly drained. Water movement in the most restrictive layer is moderately high. Available water to a depth of 60 inches (or restricted depth) is high. Shrink-swell potential is high. This soil is not flooded. It is frequently ponded. A seasonal zone of water saturation is at six inches during January, February, March, April, and May. Organic matter content in the surface horizon is about five percent. Non-irrigated land capability classification is 2w. This soil meets hydric criteria. There are no saline horizons within 30 inches of the soil surface.

The Ipava soil, Herrick soil, Piasa soil, and Timewell soil are minor components.

#### **Muscataune silt loam, zero to two percent slopes (51A)**

The Muscataune component makes up 90 percent of the map unit. Slopes are zero to two percent. This component is on ground moraines, till plains. The parent material consists of Peoria loess. Depth to a root restrictive layer is greater than 60 inches. The natural drainage class is somewhat poorly drained. Water movement in the most restrictive layer is moderately high. Available water to a depth of 60 inches (or restricted depth) is very high. Shrink-swell potential is moderate. This soil is not flooded. It is not ponded. A seasonal zone of water saturation is at 18 inches during January, February, March, April, and May. Organic matter content in the surface horizon is about five percent. Non-irrigated land capability classification is 1. This soil does not meet hydric criteria. There are no saline horizons within 30 inches of the soil surface.

The Sable soil, Osco soil, Edgington soil, Drummer soil and Denny soil are minor components.





### **Muscatune silt loam, two to five percent slopes (51B)**

The Muscatune component makes up 95 percent of the map unit. Slopes are two to five percent. This component is on till plains, ground moraines. The parent material consists of Peoria loess. Depth to a root restrictive layer is greater than 60 inches. The natural drainage class is somewhat poorly drained. Water movement in the most restrictive layer is moderately high. Available water to a depth of 60 inches (or restricted depth) is very high. Shrink-swell potential is moderate. This soil is not flooded. It is not ponded. A seasonal zone of water saturation is at 18 inches during January, February, March, April, and May. Organic matter content in the surface horizon is about five percent. Non-irrigated land capability classification is 2e. This soil does not meet hydric criteria. There are no saline horizons within 30 inches of the soil surface.

The Osco soil and Sable soil are minor components.

### **Atterberry silt loam, zero to two percent slopes (61A)**

The Atterberry component makes up 98 percent of the map unit. Slopes are zero to two percent. This component is on flats. The parent material consists of loess. Depth to a root restrictive layer is greater than 60 inches. The natural drainage class is somewhat poorly drained. Water movement in the most restrictive layer is moderately high. Available water to a depth of 60 inches is high. Shrink-swell potential is moderate. This soil is not flooded. It is not ponded. A seasonal zone of water saturation is at 15 inches during January, February, March, April, and May. Organic matter content in the surface horizon is about three percent. Non-irrigated land capability classification is 2w. This soil does not meet hydric criteria.

The Sable soil, Fayette soil, Denny soil and Rozetta soil are minor components.

### **Sable silty clay loam, zero to two percent slopes (68A)**

The Sable component makes up 85 percent of the map unit. Slopes are zero to two percent. This component is on till plains, swales. The parent material consists of loess. Depth to a root restrictive layer is greater than 60 inches. The natural drainage class is poorly drained. Water movement in the most restrictive layer is moderately high. Available water to a depth of 60 inches (or restricted depth) is high. Shrink-swell potential is moderate. This soil is not flooded. It is frequently ponded. A seasonal zone of water saturation is at six inches during January, February, March, April, and May. Organic matter content in the surface horizon is about five percent. Non-irrigated land capability classification is 2w. This soil meets hydric criteria. There are no saline horizons within 30 inches of the soil surface.

The Ipava soil, Muscatune soil, Buckhart soil and Elburn soil are minor components.

### **Menfro silt loam, two to five percent slopes (79B)**

The Menfro component makes up 90 percent of the map unit. Slopes are two to five percent. This component is on loess hills, uplands. The parent material consists of loess. Depth to a root restrictive layer is greater than 60 inches. The natural drainage class is well drained. Water movement in the most



restrictive layer is moderately high. Available water to a depth of 60 inches is high. Shrink-swell potential is moderate. This soil is not flooded. It is not ponded. There is no zone of water saturation within a depth of 72 inches. Organic matter content in the surface horizon is about two percent. Non-irrigated land capability classification is 2e. This soil does not meet hydric criteria.

**Menfro silt loam, five to 10 percent slopes, eroded (79C2)**

The Menfro component makes up 85 percent of the map unit. Slopes are five to 10 percent. This component is on uplands, loess hills. The parent material consists of loess. Depth to a root restrictive layer is greater than 60 inches. The natural drainage class is well drained. Water movement in the most restrictive layer is moderately high. Available water to a depth of 60 inches is high. Shrink-swell potential is moderate. This soil is not flooded. It is not ponded. There is no zone of water saturation within a depth of 72 inches. Organic matter content in the surface horizon is about two percent. Non-irrigated land capability classification is 3e. This soil does not meet hydric criteria.

**Menfro silt loam, 10 to 18 percent slopes, eroded (79D2)**

The Menfro component makes up 90 percent of the map unit. Slopes are 10 to 18 percent. This component is on ground moraines. The parent material consists of loess. Depth to a root restrictive layer is greater than 60 inches. The natural drainage class is well drained. Water movement in the most restrictive layer is moderately high. Available water to a depth of 60 inches is very high. Shrink-swell potential is moderate. This soil is not flooded. It is not ponded. There is no zone of water saturation within a depth of 72 inches. Organic matter content in the surface horizon is about two percent. Non-irrigated land capability classification is 3e. This soil does not meet hydric criteria.

**Oscosilt loam, two to five percent slopes (86B)**

The Oscosilt component makes up 90 percent of the map unit. Slopes are two to five percent. This component is on ground moraines, till plains. The parent material consists of loess. Depth to a root restrictive layer is greater than 60 inches. The natural drainage class is well drained. Water movement in the most restrictive layer is moderately high. Available water to a depth of 60 inches is very high. Shrink-swell potential is moderate. This soil is not flooded. It is not ponded. A seasonal zone of water saturation is at 60 inches during February, March, and April. Organic matter content in the surface horizon is about four percent. Non irrigated land capability classification is 2e. This soil does not meet hydric criteria. There are no saline horizons within 30 inches of the soil surface.

The Sable soil, Muscatune soil, Ipava soil and Denny soil are minor components.

**Oscosilt loam, five to 10 percent slopes (86C2)**

The Oscosilt component makes up 90 percent of the map unit. Slopes are five to 10 percent. This component is on till plains, ground moraines. The parent material consists of loess. Depth to a root restrictive layer is greater than 60 inches. The natural drainage class is well drained. Water movement in the most restrictive layer is moderately high. Available water to a depth of 60 inches is high. Shrink-swell potential is



moderate. This soil is not flooded. It is not ponded. A seasonal zone of water saturation is at 60 inches during February, March, and April. Organic matter content in the surface horizon is about three percent. Non-irrigated land capability classification is 3e. This soil does not meet hydric criteria. There are no saline horizons within 30 inches of the soil surface.

The Ipava soil, Muscatune soil, Radford soil and Sable soil are minor components.

**Elco silt loam, five to 10 percent slopes, eroded (119C2)**

The Elco component makes up 97 percent of the map unit. Slopes are five to 10 percent. This component is on ground moraines. The parent material consists of loess over paleosol formed in till. Depth to a root restrictive layer, densic material, is 20 to 59 inches. The natural drainage class is moderately well drained. Water movement in the most restrictive layer is moderately low. Available water to a depth of 60 inches is high. Shrink-swell potential is moderate. This soil is not flooded. It is not ponded. A seasonal zone of water saturation is at 33 inches during February, March, and April. Organic matter content in the surface horizon is about two percent. Non-irrigated land capability classification is 3e. This soil does not meet hydric criteria. The soil has a maximum sodium adsorption ratio of 1 within 30 inches of the soil surface.

**Elco silty clay loam, five to 10 percent slopes, severely eroded (119C3)**

The Elco component makes up 95 percent of the map unit. Slopes are five to 10 percent. This component is on ground moraines. The parent material consists of loess over paleosol formed in till. Depth to a root restrictive layer, densic material, is 20 to 59 inches. The natural drainage class is moderately well drained. Water movement in the most restrictive layer is moderately low. Available water to a depth of 60 inches is high. Shrink-swell potential is moderate. This soil is not flooded. It is not ponded. A seasonal zone of water saturation is at 33 inches during February, March, and April. Organic matter content in the surface horizon is about one percent. Non-irrigated land capability classification is 4e. This soil does not meet hydric criteria.

**Elco silt loam, 10 to 18 percent slopes, eroded (119D2)**

The Elco component makes up 94 percent of the map unit. Slopes are 10 to 18 percent. This component is on ground moraines. The parent material consists of loess over paleosol formed in till. Depth to a root restrictive layer, densic material, is 20 to 59 inches. The natural drainage class is moderately well drained. Water movement in the most restrictive layer is moderately low. Available water to a depth of 60 inches is high. Shrink-swell potential is moderate. This soil is not flooded. It is not ponded. A seasonal zone of water saturation is at 33 inches during February, March, and April. Organic matter content in the surface horizon is about two percent. Non-irrigated land capability classification is 3e. This soil does not meet hydric criteria.

The Thebes soil is a minor component.



### **Elco silty clay loam, 10 to 18 percent slopes, severely eroded (119D3)**

The Elco component makes up 95 percent of the map unit. Slopes are 10 to 18 percent. This component is on ground moraines. The parent material consists of loess over paleosol formed in till. Depth to a root restrictive layer, densic material, is 20 to 59 inches. The natural drainage class is moderately well drained. Water movement in the most restrictive layer is moderately low. Available water to a depth of 60 inches is high. Shrink-swell potential is high. This soil is not flooded. It is not ponded. A seasonal zone of water saturation is at 33 inches during February, March, and April. Organic matter content in the surface horizon is about one percent. Non-irrigated land capability classification is 4e. This soil does not meet hydric criteria.

### **Camden silt loam, 5 to 10 percent slopes, eroded (134C2)**

The Camden component makes up 97 percent of the map unit. Slopes are five to 10 percent. This component is on ridges and side slopes on stream terraces. The parent material consists of loess over stratified loamy outwash. Depth to a root restrictive layer is greater than 60 inches. The natural drainage class is well drained. Water movement in the most restrictive layer is moderately high. Available water to a depth of 60 inches (or restricted depth) is high. Shrink-swell potential is low. This soil is not flooded. It is not ponded. There is no zone of water saturation within a depth of 72 inches. Organic matter content in the surface horizon is about two percent. Nonirrigated land capability classification is 3e. This soil does not meet hydric criteria.

The Sawmill soil is a minor component.

### **Kendall silt loam, zero to two percent slopes (242A)**

The Kendall component makes up 90 percent of the map unit. Slopes are zero to two percent. This component is on outwash plains. The parent material consists of loess over outwash. Depth to a root restrictive layer is greater than 60 inches. The natural drainage class is somewhat poorly drained. Water movement in the most restrictive layer is moderately high. Available water to a depth of 60 inches is high. Shrink-swell potential is moderate. This soil is not flooded. It is not ponded. A seasonal zone of water saturation is at 15 inches during January, February, March, April, and May. Organic matter content in the surface horizon is about two percent. Non-irrigated land capability classification is 2w. This soil does not meet hydric criteria.

The Drummer soil, Brooklyn soil, Vesser soil and Sable soil are minor components.

### **Clarksdale silt loam, zero to two percent slopes (257A)**

The Clarksdale component makes up 90 percent of the map unit. Slopes are zero to two percent. This component is on ground moraines, till plains. The parent material consists of loess. Depth to a root restrictive layer is greater than 60 inches. The natural drainage class is somewhat poorly drained. Water movement in the most restrictive layer is moderately high. Available water to a depth of 60 inches (or restricted depth) is high. Shrink-swell potential is moderate. This soil is not flooded. It is not ponded. A



seasonal zone of water saturation is at 15 inches during January, February, March, April, and May. Organic matter content in the surface horizon is about three percent. Non-irrigated land capability classification is 1. This soil does not meet hydric criteria. There are no saline horizons within 30 inches of the soil surface.

The Rozetta soil, Greenbush soil, Virden soil and Denny soil are minor components.

**Clarksdale silt loam, two to five percent slopes (257B)**

The Clarksdale component makes up 90 percent of the map unit. Slopes are two to five percent. This component is on ground moraines, till plains. The parent material consists of loess. Depth to a root restrictive layer is greater than 60 inches. The natural drainage class is somewhat poorly drained. Water movement in the most restrictive layer is moderately high. Available water to a depth of 60 inches (or restricted depth) is high. Shrink-swell potential is moderate. This soil is not flooded. It is not ponded. A seasonal zone of water saturation is at 15 inches during January, February, March, April, and May. Organic matter content in the surface horizon is about three percent. Non-irrigated land capability classification is 2e. This soil does not meet hydric criteria. There are no saline horizons within 30 inches of the soil surface.

The Sable soil, Greenbrush soil, Denny soil and Rushville soil are minor components.

**Assumption silt loam, five to 10 percent slopes, eroded (259C2)**

The Assumption component makes up 90 percent of the map unit. Slopes are five to 10 percent. This component is on till plains, ground moraines. The parent material consists of fine-silty loess over paleosol formed in loamy till. Depth to a root restrictive layer, densic material, is 48 to 59 inches. The natural drainage class is moderately well drained. Water movement in the most restrictive layer is moderately low. Available water to a depth of 60 inches is high. Shrink-swell potential is moderate. This soil is not flooded. It is not ponded. A seasonal zone of water saturation is at 33 inches during February, March, and April. Organic matter content in the surface horizon is about three percent. Non-irrigated land capability classification is 3e. This soil does not meet hydric criteria. There are no saline horizons within 30 inches of the soil surface.

The Coatsburg soil, Radford soil, and Lawson soil are minor components.

**Caseyville silt loam, zero to two percent slopes (267A)**

The Caseyville component makes up 90 percent of the map unit. Slopes are zero to two percent. This component is on ground moraines. The parent material consists of loess. Depth to a root restrictive layer is greater than 60 inches. The natural drainage class is somewhat poorly drained. Water movement in the most restrictive layer is moderately high. Available water to a depth of 60 inches is very high. Shrink-swell potential is moderate. This soil is not flooded. It is not ponded. A seasonal zone of water saturation is at 15 inches during January, February, March, April, and May. Organic matter content in the surface horizon is about two percent. Non-irrigated land capability classification is 2w. This soil does not meet hydric criteria.

The Pierron soil is a minor component.



### **Stronghurst silt loam, zero to two percent slopes (278A)**

The Stronghurst component makes up 90 percent of the map unit. Slopes are zero to two percent. This component is on flats. The parent material consists of loess. Depth to a root restrictive layer is greater than 60 inches. The natural drainage class is somewhat poorly drained. Water movement in the most restrictive layer is moderately high. Available water to a depth of 60 inches is very high. Shrink-swell potential is moderate. This soil is not flooded. It is not ponded. A seasonal zone of water saturation is at 15 inches during January, February, March, April, and May. Organic matter content in the surface horizon is about two percent. Non-irrigated land capability classification is 2w. This soil does not meet hydric criteria.

The Edgington soil, Fayette soil, Greenbush soil, Rozetta soil, Rushville soil and Sable soil are minor components.

### **Rozetta silt loam, two to five percent slopes (279B)**

The Rozetta component makes up 90 percent of the map unit. Slopes are two to five percent. This component is on ground moraines, till plains. The parent material consists of loess. Depth to a root restrictive layer is greater than 60 inches. The natural drainage class is well drained. Water movement in the most restrictive layer is moderately high. Available water to a depth of 60 inches is very high. Shrink-swell potential is moderate. This soil is not flooded. It is not ponded. A seasonal zone of water saturation is at 60 inches during February, March, and April. Organic matter content in the surface horizon is about two percent. Non irrigated land capability classification is 2e. This soil does not meet hydric criteria. There are no saline horizons within 30 inches of the soil surface.

The Keomah component makes up 90 percent of the map unit. Slopes are zero to two percent. This component is on ground moraines, till plains. The parent material consists of loess. Depth to a root restrictive layer is greater than 60 inches. The natural drainage class is somewhat poorly drained. Water movement in the most restrictive layer is moderately low. Available water to a depth of 60 inches is high. Shrink-swell potential is moderate. This soil is not flooded. It is not ponded. A seasonal zone of water saturation is at 15 inches during January, February, March, April, and May. Organic matter content in the surface horizon is about two percent. Non-irrigated land capability classification is 2w. This soil does not meet hydric criteria. There are no saline horizons within 30 inches of the soil surface.

The Clarksdale component makes up 90 percent of the map unit. Slopes are zero to two percent. This component is on ground moraines, till plains. The parent material consists of loess. Depth to a root restrictive layer is greater than 60 inches. The natural drainage class is somewhat poorly drained. Water movement in the most restrictive layer is moderately high. Available water to a depth of 60 inches (or restricted depth) is high. Shrink-swell potential is moderate. This soil is not flooded. It is not ponded. A seasonal zone of water saturation is at 15 inches during January, February, March, April, and May. Organic matter content in the surface horizon is about three percent. Non-irrigated land capability classification is 1. This soil does not meet hydric criteria. There are no saline horizons within 30 inches of the soil surface.



The Sable component makes up 85 percent of the map unit. Slopes are zero to two percent. This component is on till plains, swales. The parent material consists of loess. Depth to a root restrictive layer is greater than 60 inches. The natural drainage class is poorly drained. Water movement in the most restrictive layer is moderately high. Available water to a depth of 60 inches (or restricted depth) is high. Shrink-swell potential is moderate. This soil is not flooded. It is frequently ponded. A seasonal zone of water saturation is at six inches during January, February, March, April, and May. Organic matter content in the surface horizon is about five percent. Non-irrigated land capability classification is 2w. This soil meets hydric criteria. There are no saline horizons within 30 inches of the soil surface.

The Stronghurst soil is a minor component.

**Rozetta silt loam, five to 10 percent slopes, eroded (279C2)**

The Rozetta component makes up 94 percent of the map unit. Slopes are five to 10 percent. This component is on till plains, ground moraines. The parent material consists of loess. Depth to a root restrictive layer is greater than 60 inches. The natural drainage class is well drained. Water movement in the most restrictive layer is moderately high. Available water to a depth of 60 inches is very high. Shrink-swell potential is moderate. This soil is not flooded. It is not ponded. A seasonal zone of water saturation is at 60 inches during February, March, and April. Organic matter content in the surface horizon is about two percent. Non irrigated land capability classification is 3e. This soil does not meet hydric criteria. There are no saline horizons within 30 inches of the soil surface.

The Keomah component makes up 90 percent of the map unit. Slopes are zero to two percent. This component is on ground moraines, till plains. The parent material consists of loess. Depth to a root restrictive layer is greater than 60 inches. The natural drainage class is somewhat poorly drained. Water movement in the most restrictive layer is moderately low. Available water to a depth of 60 inches is high. Shrink-swell potential is moderate. This soil is not flooded. It is not ponded. A seasonal zone of water saturation is at 15 inches during January, February, March, April, and May. Organic matter content in the surface horizon is about two percent. Non-irrigated land capability classification is 2w. This soil does not meet hydric criteria. There are no saline horizons within 30 inches of the soil surface.

The Atlas soil and Stronghurst soil are minor components.

**Rozetta silty clay loam, five to 10 percent slopes, severely eroded (279C3)**

The Rozetta component makes up 94 percent of the map unit. Slopes are five to 10 percent. This component is on till plains, ground moraines. The parent material consists of loess. Depth to a root restrictive layer is greater than 60 inches. The natural drainage class is well drained. Water movement in the most restrictive layer is moderately high. Available water to a depth of 60 inches (or restricted depth) is very high. Shrink-swell potential is moderate. This soil is not flooded. It is not ponded. A seasonal zone of water saturation is at 60 inches during February, March, and April. Organic matter content in the surface horizon is about one percent. Non-irrigated land capability classification is 4e. This soil does not meet hydric criteria. There are no saline horizons within 30 inches of the soil surface.



The Atlas soil, Bold soil, and Bunkum soil are minor components.

**Rozetta silt loam, 10 to 18 percent slopes, eroded (279D2)**

The Rozetta component makes up 94 percent of the map unit. Slopes are 10 to 18 percent. This component is on ground moraines, till plains. The parent material consists of loess. Depth to a root restrictive layer is greater than 60 inches. The natural drainage class is well drained. Water movement in the most restrictive layer is moderately high. Available water to a depth of 60 inches (or restricted depth) is very high. Shrink-swell potential is moderate. This soil is not flooded. It is not ponded. A seasonal zone of water saturation is at 60 inches during February, March, and April. Organic matter content in the surface horizon is about two percent. Non-irrigated land capability classification is 3e. This soil does not meet hydric criteria. There are no saline horizons within 30 inches of the soil surface.

The Atlas soil and Hickory soil are minor components.

**Rozetta silty clay loam, 10 to 18 percent slopes, severely eroded (279D3)**

The Rozetta component makes up 94 percent of the map unit. Slopes are 10 to 18 percent. This component is on ground moraines. The parent material consists of loess. Depth to a root restrictive layer is greater than 60 inches. The natural drainage class is well drained. Water movement in the most restrictive layer is moderately high. Available water to a depth of 60 inches is very high. Shrink-swell potential is low. This soil is not flooded. It is not ponded. A seasonal zone of water saturation is at 60 inches during February, March, and April. Organic matter content in the surface horizon is about one percent. Non-irrigated land capability classification is 4e. This soil does not meet hydric criteria.

The Bunkum soil and Atlas soil are minor components.

**Fayette silt loam, two to five percent slopes (280B)**

The Fayette component makes up 97 percent of the map unit. Slopes are two to five percent. This component is on ground moraines. The parent material consists of loess. Depth to a root restrictive layer is greater than 60 inches. The natural drainage class is well drained. Water movement in the most restrictive layer is moderately high. Available water to a depth of 60 inches is high. Shrink-swell potential is moderate. This soil is not flooded. It is not ponded. There is no zone of water saturation within a depth of 72 inches. Organic matter content in the surface horizon is about two percent. Non-irrigated land capability classification is 2e. This soil does not meet hydric criteria.

The Edgington soil, Keoman soil, Stronghurst soil and Atterberry soil are minor components.

**Fayette silt loam, five to 10 percent slopes (280C)**

The Fayette component makes up 95 percent of the map unit. Slopes are five to 10 percent. This component is on side slopes on ground moraines. The parent material consists of loess. Depth to a root restrictive layer is greater than 60 inches. The natural drainage class is well drained. Water movement in the most restrictive layer is moderately high. Available water to a depth of 60 inches is high. Shrink-swell





potential is moderate. This soil is not flooded. It is not ponded. There is no zone of water saturation within a depth of 72 inches. Organic matter content in the surface horizon is about two percent. Non-irrigated land capability classification is 3e. This soil does not meet hydric criteria.

The Keomah soil is a minor component.

The Thebes soil is a minor component.

**Fayette silt loam, five to 10 percent slopes, eroded (280C2)**

The Fayette component makes up 95 percent of the map unit. Slopes are five to 10 percent. This component is on side slopes on ground moraines. The parent material consists of loess. Depth to a root restrictive layer is greater than 60 inches. The natural drainage class is well drained. Water movement in the most restrictive layer is moderately high. Available water to a depth of 60 inches is high. Shrink-swell potential is moderate. This soil is not flooded. It is not ponded. There is no zone of water saturation within a depth of 72 inches. Organic matter content in the surface horizon is about two percent. Non-irrigated land capability classification is 3e. This soil does not meet hydric criteria.

The Comfrey soil is a minor component.

**Fayette silt loam, 10 to 18 percent slopes (280D)**

The Fayette component makes up 92 percent of the map unit. Slopes are 10 to 18 percent. This component is on ground moraines, uplands. The parent material consists of loess. Depth to a root restrictive layer is greater than 60 inches. The natural drainage class is well drained. Water movement in the most restrictive layer is moderately high. Available water to a depth of 60 inches is high. Shrink-swell potential is moderate. This soil is not flooded. It is not ponded. There is no zone of water saturation within a depth of 72 inches. Organic matter content in the surface horizon is about two percent. Non-irrigated land capability classification is 3e. This soil does not meet hydric criteria.

The Keomah soil and Thebes soil are minor components.

**Fayette silt loam, 10 to 18 percent slopes, eroded (280D2)**

The Fayette component makes up 95 percent of the map unit. Slopes are 10 to 18 percent. This component is on ground moraines. The parent material consists of loess. Depth to a root restrictive layer is greater than 60 inches. The natural drainage class is well drained. Water movement in the most restrictive layer is moderately high. Available water to a depth of 60 inches is high. Shrink-swell potential is moderate. This soil is not flooded. It is not ponded. There is no zone of water saturation within a depth of 72 inches. Organic matter content in the surface horizon is about two percent. Non-irrigated land capability classification is 3e. This soil does not meet hydric criteria.



**Fayette silty clay loam, 10 to 18 percent slopes, severely eroded (280D3)**

The Fayette component makes up 95 percent of the map unit. Slopes are 10 to 18 percent. This component is on ground moraines. The parent material consists of loess. Depth to a root restrictive layer is greater than 60 inches. The natural drainage class is well drained. Water movement in the most restrictive layer is moderately high. Available water to a depth of 60 inches is high. Shrink-swell potential is moderate. This soil is not flooded. It is not ponded. There is no zone of water saturation within a depth of 72 inches. Organic matter content in the surface horizon is about one percent. Non-irrigated land capability classification is 4e. This soil does not meet hydric criteria.

The Elco soil, Atlas soil and Thebes soil are minor components.

**Winfield silt loam, two to five percent slopes (477B)**

The Winfield component makes up 95 percent of the map unit. Slopes are two to five percent. This component is on ground moraines, loess hills. The parent material consists of loess. Depth to a root restrictive layer is greater than 60 inches. The natural drainage class is moderately well drained. Water movement in the most restrictive layer is moderately high. Available water to a depth of 60 inches is high. Shrink-swell potential is moderate. This soil is not flooded. It is not ponded. A seasonal zone of water saturation is at 33 inches during February, March, and April. Organic matter content in the surface horizon is about two percent. Non-irrigated land capability classification is 2e. This soil does not meet hydric criteria.

**Winfield silt loam, five to 10 percent slopes, eroded (477C2)**

The Winfield component makes up 95 percent of the map unit. Slopes are five to 10 percent. This component is on loess hills. The parent material consists of loess. Depth to a root restrictive layer is greater than 60 inches. The natural drainage class is moderately well drained. Water movement in the most restrictive layer is moderately high. Available water to a depth of 60 inches is very high. Shrink-swell potential is moderate. This soil is not flooded. It is not ponded. A seasonal zone of water saturation is at 33 inches during February, March, and April. Organic matter content in the surface horizon is about two percent. Non-irrigated land capability classification is 3e. This soil does not meet hydric criteria.

**Winfield silty clay loam, 10 to 18 percent slopes, severely eroded (477D3)**

The Winfield component makes up 90 percent of the map unit. Slopes are 10 to 18 percent. This component is on loess hills. The parent material consists of loess. Depth to a root restrictive layer is greater than 60 inches. The natural drainage class is moderately well drained. Water movement in the most restrictive layer is moderately high. Available water to a depth of 60 inches is high. Shrink-swell potential is moderate. This soil is not flooded. It is not ponded. A seasonal zone of water saturation is at 33 inches during February, March, and April. Organic matter content in the surface horizon is about one percent. Non-irrigated land capability classification is 4e. This soil does not meet hydric criteria.



### **Bunkum silt loam, two to five percent slopes, eroded (515B2)**

The Bunkum component makes up 90 percent of the map unit. Slopes are two to five percent. This component is on ground moraines. The parent material consists of loess over silty pedisegment. Depth to a root restrictive layer is greater than 60 inches. The natural drainage class is somewhat poorly drained. Water movement in the most restrictive layer is moderately high. Available water to a depth of 60 inches is high. Shrink-swell potential is moderate. This soil is not flooded. It is not ponded. A seasonal zone of water saturation is at 18 inches during January, February, March, April, and May. Organic matter content in the surface horizon is about two percent. Non-irrigated land capability classification is 2e. This soil does not meet hydric criteria.

### **Bunkum silt loam, five to 10 percent slopes, eroded (515C2)**

The Bunkum, eroded component makes up 92 percent of the map unit. Slopes are five to 10 percent. This component is on ground moraines, uplands. The parent material consists of loess over silty pedisegment. Depth to a root restrictive layer is greater than 60 inches. The natural drainage class is somewhat poorly drained.

Water movement in the most restrictive layer is moderately high. Available water to a depth of 60 inches (or restricted depth) is high. Shrink-swell potential is moderate. This soil is not flooded. It is not ponded. A seasonal zone of water saturation is at 18 inches during January, February, March, April, May, November, and December. Organic matter content in the surface horizon is about two percent. Non-irrigated land capability classification is 3e. This soil does not meet hydric criteria. There are no saline horizons within 30 inches of the soil surface.

The Rozetta soil is a minor component.

### **Bunkum silty clay loam, five to 10 percent slopes, severely eroded (515C3)**

The Bunkum, severely eroded component makes up 93 percent of the map unit. Slopes are five to 10 percent. This component is on uplands, ground moraines. The parent material consists of loess over silty pedisegment. Depth to a root restrictive layer is greater than 60 inches. The natural drainage class is somewhat poorly drained. Water movement in the most restrictive layer is moderately high. Available water to a depth of 60 inches (or restricted depth) is high. Shrink-swell potential is moderate. This soil is not flooded. It is not ponded. A seasonal zone of water saturation is at 18 inches during January, February, March, April, May, November, and December. Organic matter content in the surface horizon is about one percent. Non-irrigated land capability classification is 4e. This soil does not meet hydric criteria. There are no saline horizons within 30 inches of the soil surface.

The Rozetta soil is a minor component.



### **Greenbush silt loam, two to five percent slopes (675B)**

The Greenbush component makes up 95 percent of the map unit. Slopes are two to five percent. This component is on ground moraines. The parent material consists of loess. Depth to a root restrictive layer is greater than 60 inches. The natural drainage class is well drained. Water movement in the most restrictive layer is moderately high. Available water to a depth of 60 inches is high. Shrink-swell potential is moderate. This soil is not flooded. It is not ponded. A seasonal zone of water saturation is at 60 inches during February, March, and April. Organic matter content in the surface horizon is about three percent. Non-irrigated land capability classification is 2e. This soil does not meet hydric criteria.

The Sable soil and Denny soil are minor components.

### **Greenbush silt loam, five to 10 percent slopes, eroded (675C2)**

The Greenbush component makes up 91 percent of the map unit. Slopes are five to 10 percent. This component is on ridges and side slopes on ground moraines. The parent material consists of loess. Depth to a root restrictive layer is greater than 60 inches. The natural drainage class is well drained. Water movement in the most restrictive layer is moderately high. Available water to a depth of 60 inches is high. Shrink-swell potential is moderate. This soil is not flooded. It is not ponded. A seasonal zone of water saturation is at 60 inches during February, March, and April. Organic matter content in the surface horizon is about two percent. Non-irrigated land capability classification is 3e. This soil does not meet hydric criteria.

The Emery soil, Bunkum soil and Atterberry soil are minor components.

### **Goss-Menfro complex, 35 to 60 percent slopes (833G)**

The Goss component makes up 60 percent of the map unit. Slopes are 35 to 60 percent. This component is on hillslopes. The parent material consists of clayey residuum weathered from cherty limestone. Depth to a root restrictive layer, abrupt textural change, is two to 30 inches. The natural drainage class is well drained. Water movement in the most restrictive layer is moderately high. Available water to a depth of 60 inches is low. Shrink-swell potential is moderate. This soil is not flooded. It is not ponded. There is no zone of water saturation within a depth of 72 inches. Organic matter content in the surface horizon is about two percent. Non-irrigated land capability classification is 7e. This soil does not meet hydric criteria.

The Menfro component makes up 30 percent of the map unit. Slopes are 35 to 60 percent. This component is on hillslopes. The parent material consists of loess. Depth to a root restrictive layer is greater than 60 inches. The natural drainage class is well drained. Water movement in the most restrictive layer is moderately high. Available water to a depth of 60 inches is high. Shrink-swell potential is moderate. This soil is not flooded. It is not ponded. There is no zone of water saturation within a depth of 72 inches. Organic matter content in the surface horizon is about two percent. Non-irrigated land capability classification is 7e. This soil does not meet hydric criteria.



### **Rock outcrop, limestone-Lacrescent complex, 35 to 60 percent slopes (837G)**

The Rock outcrop is a miscellaneous area.

The Lacrescent component makes up 30 percent of the map unit. Slopes are 35 to 60 percent. This component is on bluffs. The parent material consists of Colluvium. Depth to a root restrictive layer is greater than 60 inches. The natural drainage class is well drained. Water movement in the most restrictive layer is moderately high. Available water to a depth of 60 inches is moderate. Shrink-swell potential is low. This soil is not flooded. It is not ponded. There is no zone of water saturation within a depth of 72 inches. Organic matter content in the surface horizon is about four percent. Non-irrigated land capability classification is 7e. This soil does not meet hydric criteria. The calcium carbonate equivalent within 40 inches, typically, does not exceed three percent.

### **Elco-Ursa silt loams, 10 to 18 percent slopes, eroded (915D2)**

The Elco component makes up 55 percent of the map unit. Slopes are 10 to 18 percent. This component is on hillslopes. The parent material consists of loess. Depth to a root restrictive layer, densic material, is 20 to 59 inches. The natural drainage class is moderately well drained. Water movement in the most restrictive layer is moderately low. Available water to a depth of 60 inches is high. Shrink-swell potential is moderate. This soil is not flooded. It is not ponded. A seasonal zone of water saturation is at 33 inches during February, March, and April. Organic matter content in the surface horizon is about two percent. Non-irrigated land capability classification is 4e. This soil does not meet hydric criteria. The calcium carbonate equivalent within 40 inches, typically, does not exceed five percent. The soil has a maximum sodium adsorption ratio of 3 within 30 inches of the soil surface.

The Ursa component makes up 35 percent of the map unit. Slopes are 10 to 18 percent. This component is on hillslopes. The parent material consists of loess. Depth to a root restrictive layer, densic material, is 10 to 30 inches. The natural drainage class is well drained. Water movement in the most restrictive layer is moderately low. Available water to a depth of 60 inches is moderate. Shrink-swell potential is high. This soil is not flooded. It is not ponded. A seasonal zone of water saturation is at 60 inches during February, March, and April. Organic matter content in the surface horizon is about two percent. Non-irrigated land capability classification is 4e. This soil does not meet hydric criteria.

### **Beaucoup silty clay loam, zero to two percent slopes, frequently flooded (3070A)**

The Beaucoup component makes up 85 percent of the map unit. Slopes are zero to two percent. This component is on floodplains. The parent material consists of silty alluvium. Depth to a root restrictive layer is greater than 60 inches. The natural drainage class is poorly drained. Water movement in the most restrictive layer is moderately high. Available water to a depth of 60 inches is high. Shrink-swell potential is moderate. This soil is frequently flooded. It is frequently ponded. A seasonal zone of water saturation is at six inches during January, February, March, April, and May. Organic matter content in the surface horizon is about six percent. Non-irrigated land capability classification is 3w. This soil meets hydric criteria.



The Thorp soil is a minor component.

**Radford silt loam, zero to two percent slopes, frequently flooded (3074A)**

The Radford component makes up 90 percent of the map unit. Slopes are zero to two percent. This component is on floodplains. The parent material consists of alluvium. Depth to a root restrictive layer is greater than 60 inches. The natural drainage class is somewhat poorly drained. Water movement in the most restrictive layer is moderately high. Available water to a depth of 60 inches is high. Shrink-swell potential is moderate. This soil is frequently flooded. It is not ponded. A seasonal zone of water saturation is at 18 inches during January, February, March, April, and May. Organic matter content in the surface horizon is about three percent. Non-irrigated land capability classification is 3w. This soil does not meet hydric criteria.

The Sawmill soil is a minor component.

**Arenzville silt loam, zero to two percent slopes, frequently flooded (3078A)**

The Arenzville component makes up 95 percent of the map unit. Slopes are zero to two percent. This component is on floodplains. The parent material consists of silty alluvium. Depth to a root restrictive layer is greater than 60 inches. The natural drainage class is well drained. Water movement in the most restrictive layer is moderately high. Available water to a depth of 60 inches is very high. Shrink-swell potential is low. This soil is frequently flooded. It is not ponded. A seasonal zone of water saturation is at 57 inches during February, March, and April. Organic matter content in the surface horizon is about two percent. Non-irrigated land capability classification is 2w. This soil does not meet hydric criteria.

**Haymond silt loam, zero to two percent slopes, frequently flooded (3331A)**

The Haymond component makes up 90 percent of the map unit. Slopes are zero to two percent. This component is on floodplains. The parent material consists of silty alluvium. Depth to a root restrictive layer is greater than 60 inches. The natural drainage class is well drained. Water movement in the most restrictive layer is moderately high. Available water to a depth of 60 inches is very high. Shrink-swell potential is low. This soil is frequently flooded. It is not ponded. There is no zone of water saturation within a depth of 72 inches. Organic matter content in the surface horizon is about two percent. Non-irrigated land capability classification is 2w. This soil does not meet hydric criteria.

The Twomile soil is a minor component.

**Wakeland silt loam, zero to two percent slopes, frequently flooded (3333A)**

The Wakeland component makes up 90 percent of the map unit. Slopes are zero to two percent. This component is on floodplains. The parent material consists of alluvium. Depth to a root restrictive layer is greater than 60 inches. The natural drainage class is somewhat poorly drained. Water movement in the most restrictive layer is moderately high. Available water to a depth of 60 inches is very high. Shrink-swell potential is low. This soil is frequently flooded. It is not ponded. A seasonal zone of water saturation is at



15 inches during January, February, March, April, and May. Organic matter content in the surface horizon is about two percent. Non-irrigated land capability classification is 2w. This soil does not meet hydric criteria.

The Sawmill soil and Birds soil are minor components.

**Lawson silt loam, zero to two percent slopes, frequently flooded (3451A)**

The Lawson component makes up 92 percent of the map unit. Slopes are zero to two percent. This component is on floodplains. The parent material consists of silty alluvium. Depth to a root restrictive layer is greater than 60 inches. The natural drainage class is somewhat poorly drained. Water movement in the most restrictive layer is moderately high. Available water to a depth of 60 inches is very high. Shrink-swell potential is low. This soil is frequently flooded. It is not ponded. A seasonal zone of water saturation is at 18 inches during January, February, March, April, and May. Organic matter content in the surface horizon is about three percent. Non-irrigated land capability classification is 3w. This soil does not meet hydric criteria.

The Comfrey soil, Sawmill soil, Otter soil, Birds soil and Zook soil are minor components.

**Elsah gravelly loam, zero to two percent slopes, frequently flooded (3475A)**

The Elsah component makes up 90 percent of the map unit. Slopes are zero to two percent. This component is on floodplains. The parent material consists of gravelly alluvium. Depth to a root restrictive layer is greater than 60 inches. The natural drainage class is well drained. Water movement in the most restrictive layer is moderately high. Available water to a depth of 60 inches is low. Shrink-swell potential is low. This soil is frequently flooded. It is not ponded. There is no zone of water saturation within a depth of 72 inches. Organic matter content in the surface horizon is about two percent. Non-irrigated land capability classification is 2s. This soil does not meet hydric criteria.

**Blyton silt loam, zero to two percent slopes, frequently flooded (3634A)**

The Blyton component makes up 90 percent of the map unit. Slopes are zero to two percent. This component is on floodplains. The parent material consists of silty alluvium. Depth to a root restrictive layer is greater than 60 inches. The natural drainage class is moderately well drained. Water movement in the most restrictive layer is moderately high. Available water to a depth of 60 inches is very high. Shrink-swell potential is low. This soil is frequently flooded. It is not ponded. A seasonal zone of water saturation is at 33 inches during February, March, and April. Organic matter content in the surface horizon is about two percent. Non irrigated land capability classification is 2w. This soil does not meet hydric criteria.

The Twomile soil and Birds soil are minor components.



### **Proctor silt loam, zero to two percent slopes, rarely flooded (7148A)**

The Proctor component makes up 95 percent of the map unit. Slopes are zero to two percent. This component is on floodplains. The parent material consists of loess over outwash. Depth to a root restrictive layer is greater than 60 inches. The natural drainage class is well drained. Water movement in the most restrictive layer is moderately high. Available water to a depth of 60 inches is high. Shrink-swell potential is low. This soil is rarely flooded. It is not ponded. There is no zone of water saturation within a depth of 72 inches. Organic matter content in the surface horizon is about four percent. Non irrigated land capability classification is 1. This soil does not meet hydric criteria.

The Sawmill soil is a minor component.

### **Water (W)**

The Water is a miscellaneous area.

## **7-B.2 Missouri**

### **Booker silty clay, frequently ponded, zero to two percent slopes, occasionally flooded (13598)**

The Booker component makes up 95 percent of the map unit. Slopes are zero to two percent. This component is on river valleys and floodplain steps. The parent material consists of alluvium. Depth to a root restrictive layer is greater than 60 inches. The natural drainage class is very poorly drained. Water movement in the most restrictive layer is low. Available water to a depth of 60 inches is moderate. Shrink-swell potential is very high. This soil is occasionally flooded. It is frequently ponded. Non-irrigated land capability classification is 5w. This soil meets hydric criteria.

### **Landes fine sandy loam, zero to two percent slopes, occasionally flooded (36023)**

The Landes component makes up 90 percent of the map unit. Slopes are zero to two percent. This component is on floodplain steps and river valleys. The parent material consists of alluvium. Depth to a root restrictive layer is greater than 60 inches. The natural drainage class is moderately well drained. Water movement in the most restrictive layer is moderately high. Available water to a depth of 60 inches is moderate. Shrink-swell potential is low. This soil is occasionally flooded. It is not ponded. A seasonal zone of water saturation is at 60 inches during January, February, March, April, May, November, and December. Organic matter content in the surface horizon is about two percent. Non-irrigated land capability classification is 2w. This soil does not meet hydric criteria. The calcium carbonate equivalent within 40 inches, typically, does not exceed two percent. There are no saline horizons within 30 inches of the soil surface.

The Sarpy soil is a minor component.





#### **Menfro silt loam, five to nine percent slopes, eroded (60001)**

The Menfro component makes up 100 percent of the map unit. Slopes are five to nine percent. This component is on hills, hillslopes. The parent material consists of loess. Depth to a root restrictive layer is greater than 60 inches. The natural drainage class is well drained. Water movement in the most restrictive layer is moderately high. Available water to a depth of 60 inches is high. Shrink-swell potential is moderate. This soil is not flooded. It is not ponded. There is no zone of water saturation within a depth of 72 inches. Organic matter content in the surface horizon is about four percent. Non-irrigated land capability classification is 3e. This soil does not meet hydric criteria. There are no saline horizons within 30 inches of the soil surface.

#### **Menfro silt loam, nine to 14 percent slopes, eroded (60003)**

The Menfro component makes up 85 percent of the map unit. Slopes are nine to 14 percent. This component is on hills, hillslopes. The parent material consists of loess. Depth to a root restrictive layer is greater than 60 inches. The natural drainage class is well drained. Water movement in the most restrictive layer is moderately high. Available water to a depth of 60 inches is high. Shrink-swell potential is moderate. This soil is not flooded. It is not ponded. There is no zone of water saturation within a depth of 72 inches. Organic matter content in the surface horizon is about three percent. Non-irrigated land capability classification is 4e. This soil does not meet hydric criteria.

#### **Menfro silt loam, 14 to 20 percent slopes, eroded (60004)**

The Menfro component makes up 90 percent of the map unit. Slopes are 14 to 20 percent. This component is on hillslopes, hills. The parent material consists of loess. Depth to a root restrictive layer is greater than 60 inches. The natural drainage class is well drained. Water movement in the most restrictive layer is moderately high. Available water to a depth of 60 inches is high. Shrink-swell potential is moderate. This soil is not flooded. It is not ponded. There is no zone of water saturation within a depth of 72 inches. Organic matter content in the surface horizon is about four percent. Non-irrigated land capability classification is 6e. This soil does not meet hydric criteria. There are no saline horizons within 30 inches of the soil surface.

The Goss soil is a minor component.

#### **Menfro silt loam, 20 to 45 percent slopes (60005)**

The Menfro component makes up 89 percent of the map unit. Slopes are 20 to 45 percent. This component is on hills, hillslopes. The parent material consists of loess. Depth to a root restrictive layer is greater than 60 inches. The natural drainage class is well drained. Water movement in the most restrictive layer is moderately high. Available water to a depth of 60 inches is high. Shrink-swell potential is moderate. This soil is not flooded. It is not ponded. There is no zone of water saturation within a depth of 72 inches. Organic matter content in the surface horizon is about four percent. Non-irrigated land capability classification is 6e. This soil does not meet hydric criteria. There are no saline horizons within 30 inches of the soil surface.



The Goss soil and Rock outcrop soil are minor components.

**Urban land-Harvester complex, two to nine percent slopes (60025)**

The Harvester component makes up 40 percent of the map unit. Slopes are two to nine percent. This component is on hills, interfluves. The parent material consists of loess. Depth to a root restrictive layer is greater than 60 inches. The natural drainage class is moderately well drained. Water movement in the most restrictive layer is moderately high. Available water to a depth of 60 inches is moderate. Shrink-swell potential is moderate. This soil is not flooded. It is not ponded. A seasonal zone of water saturation is at 34 inches during January, February, March, April, May, November, and December. Organic matter content in the surface horizon is about one percent. Non-irrigated land capability classification is 3e. This soil does not meet hydric criteria.

The Urban land is a miscellaneous area.

**Menfro silt loam, two to five percent slopes (60165)**

The Menfro component makes up 85 percent of the map unit. Slopes are two to five percent. This component is on interfluves, hills. The parent material consists of loess. Depth to a root restrictive layer is greater than 60 inches. The natural drainage class is well drained. Water movement in the most restrictive layer is moderately high. Available water to a depth of 60 inches is high. Shrink-swell potential is moderate. This soil is not flooded. It is not ponded. There is no zone of water saturation within a depth of 72 inches. Organic matter content in the surface horizon is about three percent. Non-irrigated land capability classification is 2e. This soil does not meet hydric criteria.

**Menfro silt loam, karst, two to 14 percent slopes, eroded (60171)**

The Menfro, karst component makes up 90 percent of the map unit. Slopes are two to 14 percent. This component is on hills, hillslopes. The parent material consists of loess. Depth to a root restrictive layer is greater than 60 inches. The natural drainage class is well drained. Water movement in the most restrictive layer is moderately high. Available water to a depth of 60 inches is high. Shrink-swell potential is moderate. This soil is not flooded. It is not ponded. There is no zone of water saturation within a depth of 72 inches. Organic matter content in the surface horizon is about four percent. Non-irrigated land capability classification is 3e. This soil does not meet hydric criteria. There are no saline horizons within 30 inches of the soil surface. Generated brief soil descriptions are created for major components.

The Caneyville soil and Moniteau soil are minor components.

**Menfro silt loam, karst, nine to 35 percent slopes (60176)**

The Menfro, karst component makes up 85 percent of the map unit. Slopes are nine to 35 percent. This component is on hills, hillslopes. The parent material consists of loess. Depth to a root restrictive layer is greater than 60 inches. The natural drainage class is well drained. Water movement in the most restrictive layer is moderately high. Available water to a depth of 60 inches is high. Shrink-swell potential is



moderate. This soil is not flooded. It is not ponded. There is no zone of water saturation within a depth of 72 inches. Organic matter content in the surface horizon is about four percent. Non-irrigated land capability classification is 6e. This soil does not meet hydric criteria.

**Urban land-Harvester complex, nine to 20 percent slopes (60223)**

The Harvester component makes up 25 percent of the map unit. Slopes are nine to 20 percent. This component is on hillslopes, hills. The parent material consists of loess. Depth to a root restrictive layer is greater than 60 inches. The natural drainage class is moderately well drained. Water movement in the most restrictive layer is moderately high. Available water to a depth of 60 inches is moderate. Shrink-swell potential is moderate. This soil is not flooded. It is not ponded. A seasonal zone of water saturation is at 34 inches during January, February, March, April, May, November, and December. Organic matter content in the surface horizon is about one percent. Non-irrigated land capability classification is 6e. This soil does not meet hydric criteria.

The Urban land is a miscellaneous area.

**Urban land-Harvester complex, karst, two to nine percent slopes (60224)**

The Harvester, karst component makes up 30 percent of the map unit. Slopes are two to nine percent. This component is on hillslopes, hills. The parent material consists of loess. Depth to a root restrictive layer is greater than 60 inches. The natural drainage class is moderately well drained. Water movement in the most restrictive layer is moderately high. Available water to a depth of 60 inches is moderate. Shrink-swell potential is moderate. This soil is not flooded. It is not ponded. A seasonal zone of water saturation is at 34 inches during January, February, March, April, May, November, and December. Organic matter content in the surface horizon is about one percent. Non-irrigated land capability classification is 3e. This soil does not meet hydric criteria.

The Urban land is a miscellaneous area.

**Blase silty clay loam, zero to two percent slopes, rarely flooded (64016)**

The Blase component makes up 95 percent of the map unit. Slopes are zero to two percent. This component is on river valleys, stream terraces. The parent material consists of clayey alluvium over loamy alluvium. Depth to a root restrictive layer, strongly contrasting textural stratification, is 20 to 40 inches. The natural drainage class is somewhat poorly drained. Water movement in the most restrictive layer is moderately low. Available water to a depth of 60 inches is high. Shrink-swell potential is moderate. This soil is rarely flooded. It is not ponded. A seasonal zone of water saturation is at 20 inches during January, February, March, April, May, November, and December. Organic matter content in the surface horizon is about one percent. Non-irrigated land capability classification is 2w. This soil does not meet hydric criteria. The calcium carbonate equivalent within 40 inches, typically, does not exceed four percent.



#### **DeSioux loam, zero to two percent slopes, rarely flooded (64024)**

The DeSioux component makes up 95 percent of the map unit. Slopes are zero to two percent. This component is on stream terraces, river valleys. The parent material consists of alluvium. Depth to a root restrictive layer is greater than 60 inches. The natural drainage class is well drained. Water movement in the most restrictive layer is moderately high. Available water to a depth of 60 inches is high. Shrink-swell potential is low. This soil is rarely flooded. It is not ponded. A seasonal zone of water saturation is at 57 inches during January, February, March, April, May, November, and December. Organic matter content in the surface horizon is about three percent. Non-irrigated land capability classification is 1. This soil does not meet hydric criteria.

The Landes soil is a minor component.

#### **Blake silt loam, zero to two percent slopes, frequently flooded (66012)**

The Blake component makes up 85 percent of the map unit. Slopes are zero to two percent. This component is on river valleys, floodplains. The parent material consists of alluvium. Depth to a root restrictive layer is greater than 60 inches. The natural drainage class is somewhat poorly drained. Water movement in the most restrictive layer is moderately high. Available water to a depth of 60 inches is very high. Shrink-swell potential is moderate. This soil is frequently flooded. It is not ponded. A seasonal zone of water saturation is at 14 inches during January, February, March, April, May, November, and December. Organic matter content in the surface horizon is about three percent. Non-irrigated land capability classification is 5w. Irrigated land capability classification is 1. This soil meets hydric criteria. The calcium carbonate equivalent within 40 inches, typically, does not exceed 18 percent.

The SansDessein soil and Haynie soil are minor components.

#### **Lowmo silt loam, zero to two percent slopes, occasionally flooded (66019)**

The Lowmo component makes up 85 percent of the map unit. Slopes are zero to two percent. This component is on floodplain steps and river valleys. The parent material consists of alluvium. Depth to a root restrictive layer is greater than 60 inches. The natural drainage class is well drained. Water movement in the most restrictive layer is moderately high. Available water to a depth of 60 inches is very high. Shrink-swell potential is low. This soil is occasionally flooded. It is not ponded. A seasonal zone of water saturation is at 48 inches during January, February, March, April, May, November, and December. Organic matter content in the surface horizon is about two percent. Non-irrigated land capability classification is 2w. This soil does not meet hydric criteria. The calcium carbonate equivalent within 40 inches, typically, does not exceed one percent.

The Peers soil, SansDessein soil and Treloar soil are minor components.



#### **Wilbur silt loam, zero to two percent slopes, frequently flooded (66024)**

The Wilbur component makes up 80 percent of the map unit. Slopes are zero to two percent. This component is on floodplains, river valleys. The parent material consists of alluvium. Depth to a root restrictive layer is greater than 60 inches. The natural drainage class is moderately well drained. Water movement in the most restrictive layer is moderately high. Available water to a depth of 60 inches is very high. Shrink-swell potential is low. This soil is frequently flooded. It is not ponded. A seasonal zone of water saturation is at 21 inches during January, February, March, April, May, November, and December. Organic matter content in the surface horizon is about two percent. Non-irrigated land capability classification is 3w. This soil does not meet hydric criteria.

The Moniteau soil and Wilbur soil are minor components.

#### **Peers silty clay loam, zero to two percent slopes, occasionally flooded (66059)**

The Peers component makes up 85 percent of the map unit. Slopes are zero to two percent. This component is on river valleys and floodplain steps. The parent material consists of alluvium. Depth to a root restrictive layer is greater than 60 inches. The natural drainage class is somewhat poorly drained. Water movement in the most restrictive layer is moderately high. Available water to a depth of 60 inches is very high. Shrink-swell potential is low. This soil is occasionally flooded. It is not ponded. A seasonal zone of water saturation is at 22 inches during January, February, March, April, May, November, and December. Organic matter content in the surface horizon is about two percent. Non-irrigated land capability classification is 2w. This soil does not meet hydric criteria. The calcium carbonate equivalent within 40 inches, typically, does not exceed one percent.

The SansDessein soil and Lowmo soil are minor components.

#### **Carlow silty clay loam, zero to two percent slopes, occasionally flooded (66066)**

The Carlow component makes up 90 percent of the map unit. Slopes are zero to two percent. This component is on river valleys and floodplain steps. The parent material consists of alluvium. Depth to a root restrictive layer is greater than 60 inches. The natural drainage class is poorly drained. Water movement in the most restrictive layer is low. Available water to a depth of 60 inches is moderate. Shrink-swell potential is very high. This soil is occasionally flooded. It is not ponded. A seasonal zone of water saturation is at six inches during January, February, March, April, May, November, and December. Organic matter content in the surface horizon is about three percent. Non-irrigated land capability classification is 3w. This soil meets hydric criteria.

#### **Portage clay, zero to two percent slopes, occasionally flooded, frequently ponded (66100)**

The Portage component makes up 85 percent of the map unit. Slopes are zero to two percent. This component is on river valleys and floodplain steps. The parent material consists of alluvium. Depth to a root restrictive layer is greater than 60 inches. The natural drainage class is very poorly drained. Water movement in the most restrictive layer is low. Available water to a depth of 60 inches is moderate. Shrink-



swell potential is very high. This soil is occasionally flooded. It is frequently ponded. A seasonal zone of water saturation is at six inches during January, February, March, April, May, November, and December. Organic matter content in the surface horizon is about four percent. Non-irrigated land capability classification is 5w. This soil meets hydric criteria.

**SansDessein silty clay, zero to two percent slopes, occasionally flooded (66110)**

The SansDessein component makes up 90 percent of the map unit. Slopes are zero to two percent. This component is on river valleys and floodplain steps. The parent material consists of alluvium. Depth to a root restrictive layer is greater than 60 inches. The natural drainage class is poorly drained. Water movement in the most restrictive layer is moderately low. Available water to a depth of 60 inches is moderate. Shrink-swell potential is very high. This soil is occasionally flooded. It is not ponded. A seasonal zone of water saturation is at eight inches during January, February, March, April, May, November, and December. Organic matter content in the surface horizon is about two percent. Non-irrigated land capability classification is 3w. This soil meets hydric criteria. The calcium carbonate equivalent within 40 inches, typically, does not exceed two percent.

The Blencoe soil and Peers soil are minor components.

**Haynie-Treloar-Blake complex, zero to two percent slopes, frequently flooded (66126)**

The Haynie component makes up 45 percent of the map unit. Slopes are zero to two percent. This component is on river valleys, floodplains. The parent material consists of alluvium. Depth to a root restrictive layer is greater than 60 inches. The natural drainage class is well drained. Water movement in the most restrictive layer is moderately high. Available water to a depth of 60 inches is very high. Shrink-swell potential is low. This soil is frequently flooded. It is not ponded. There is no zone of water saturation within a depth of 72 inches. Organic matter content in the surface horizon is about three percent. Non-irrigated land capability classification is 5w. This soil meets hydric criteria. The calcium carbonate equivalent within 40 inches, typically, does not exceed five percent.

The Treloar component makes up 25 percent of the map unit. Slopes are zero to two percent. This component is on river valleys and floodplain steps. The parent material consists of sandy alluvium over loamy alluvium. Depth to a root restrictive layer, strongly contrasting textural stratification, is 16 to 39 inches. The natural drainage class is moderately well drained. Water movement in the most restrictive layer is moderately high. Available water to a depth of 60 inches is moderate. Shrink-swell potential is low. This soil is frequently flooded. It is not ponded. A seasonal zone of water saturation is at 28 inches during January, February, March, April, May, November, and December. Organic matter content in the surface horizon is about one percent. Non-irrigated land capability classification is 5w. This soil meets hydric criteria. The calcium carbonate equivalent within 40 inches, typically, does not exceed three percent.



The Blake component makes up 20 percent of the map unit. Slopes are zero to two percent. This component is on river valleys, floodplains. The parent material consists of alluvium. Depth to a root restrictive layer is greater than 60 inches. The natural drainage class is somewhat poorly drained. Water movement in the most restrictive layer is moderately high. Available water to a depth of 60 inches is very high. Shrink-swell potential is low. This soil is frequently flooded. It is not ponded. A seasonal zone of water saturation is at 14 inches during January, February, March, April, May, November, and December. Organic matter content in the surface horizon is about three percent. Non-irrigated land capability classification is 5w. This soil meets hydric criteria. The calcium carbonate equivalent within 40 inches, typically, does not exceed five percent.

The SansDessein soil and Sarpy soil are minor components.

**Pits, quarry (99000)**

The Pits is a miscellaneous area.



**APPENDIX 7-C**  
**Agricultural Impact Mitigation Agreement**



**AMENDMENT #1 TO**  
**AGRICULTURAL IMPACT MITIGATION AGREEMENT**  
**between**  
**SPIRE STL PIPELINE LLC**  
**and the**  
**ILLINOIS DEPARTMENT OF AGRICULTURE**  
**Pertaining to the Construction of the**  
**SPIRE STL PIPELINE PROJECT**  
**A NATURAL GAS PIPELINE AND RELATED APPURTENANCES**  
**in**  
**SCOTT, GREENE and JERSEY COUNTIES, ILLINOIS**

The Agricultural Impact Mitigation Agreement entered into between the above parties on March 15, 2017 is amended as follows:

1. The following language, which is the second paragraph of the agreement and relates to the description of the project, is struck:

Spire is proposing to build, operate, and maintain the Spire STL Pipeline Project (Project). The Project consists of approximately 59 miles of new 24-inch-diameter natural gas pipeline commencing in Scott County, Illinois at an interconnect with the existing Rockies Express Pipeline LLC (REX) and traversing south through Greene and Jersey Counties, Illinois and into St. Charles and St. Louis Counties, Missouri. The 24-inch-diameter pipeline will tie into an existing 20-inch diameter pipeline in St. Louis County, Missouri that is currently owned and operated by Laclede Gas Company (LGC). As part of the Project, Spire also intends on modifying portions of this approximate 7.0-mile existing 20-inch-diameter pipeline to make it interstate serviceable. The Project will also include the construction of four new metering and regulating (M&R) facilities (one M&R facility in Scott County, Illinois and three M&R facilities in St. Louis County, Missouri), access roads and other minor aboveground appurtenant facilities. Construction is anticipated to commence in the first quarter of 2018.

2. The following language shall replace the language deleted above:

Spire is proposing to build, operate, and maintain the Spire STL Pipeline Project (Project). The proposed Project will consist of approximately 65 miles of new, greenfield, 24-inch-diameter steel pipeline in two segments. The first segment (referred to as the "24-inch pipeline" portion of the Project) will originate at a new interconnect with the Rockies Express Pipeline LLC (REX) pipeline in Scott County, Illinois and extend approximately 59 miles through Greene and Jersey Counties in Illinois before crossing the Mississippi River and extending east through St. Charles County, Missouri. The 24-inch pipeline then crosses the Missouri River into St. Louis County, Missouri, and terminates at a new interconnect with Laclede Gas Company (LGC). The second segment of new, greenfield pipeline (referred to as the "North County Extension"), will consist of a 24-inch-diameter steel pipeline which will extend approximately six miles from the LGC interconnect through the northern portion of St. Louis County and terminate at a new interconnect with Enable Mississippi River Transmission, LLC (Enable MRT) and LGC. The total length of the Project pipeline will be approximately 65

miles. The overall design capacity of the Project pipeline is expected to be 400,000 dekatherms per day (Dth/d). No compression will be required. The Project also includes the construction of three new metering and regulating (M&R) stations that provide interconnects with (1) REX in Illinois, (2) LGC in Missouri, and (3) Enable MRT and LGC in Missouri. Construction is anticipated to commence in the first quarter of 2018.

This Amendment shall be effective upon execution by both parties.

**State of Illinois  
DEPARTMENT OF AGRICULTURE**

  
(signature)

Raymond Poe, Director

Illinois Department of Agriculture  
63101 State Fairgrounds  
P.O. Box 19281  
Springfield, IL 62794-9281

**SPIRE STL PIPELINE LLC**

  
(signature)

Castor Armesto, General Counsel

700 Market Street  
St. Louis, Missouri 63101

  
(signature)

By Craig Sondgeroth, General Counsel

801 E. Sangamon Avenue  
Springfield, IL 62702

April 13, 2017

April 12, 2017

**AGRICULTURAL IMPACT MITIGATION AGREEMENT**  
**between**  
**SPIRE STL PIPELINE LLC**  
**and the**  
**ILLINOIS DEPARTMENT OF AGRICULTURE**  
**Pertaining to the Construction of the**  
**SPIRE STL PIPELINE PROJECT**  
**A NATURAL GAS PIPELINE AND RELATED APPURTENANCES**  
**in**  
**SCOTT, GREENE and JERSEY COUNTIES, ILLINOIS**

The Illinois Department of Agriculture (IDOA) and Spire STL Pipeline LLC (Spire) agree to the following measures which Spire will implement as it constructs a natural gas pipeline under agricultural land in Scott, Greene, and Jersey Counties, Illinois, as described in Spire's application to the Federal Energy Regulatory Commission (FERC) under Section 7(c) of the Natural Gas Act for a Certificate of Public Convenience and Necessity (Certificate), FERC Docket No. PF16-9-000, CP17-40-000. The mitigative actions outlined in this Agricultural Impact Mitigation Agreement (AIMA) will serve to minimize the negative impacts that may occur due to pipeline construction. The natural gas pipeline system subject to this AIMA is described below.

Spire is proposing to build, operate, and maintain the Spire STL Pipeline Project (Project). The Project consists of approximately 59 miles of new 24-inch-diameter natural gas pipeline commencing in Scott County, Illinois at an interconnect with the existing Rockies Express Pipeline LLC (REX) and traversing south through Greene and Jersey Counties, Illinois and into St. Charles and St. Louis Counties, Missouri. The 24-inch-diameter pipeline will tie into an existing 20-inch diameter pipeline in St. Louis County, Missouri that is currently owned and operated by Laclede Gas Company (LGC). As part of the Project, Spire also intends on modifying portions of this approximate 7.0-mile existing 20-inch-diameter pipeline to make it interstate serviceable. The Project will also include the construction of four new metering and regulating (M&R) facilities (one M&R facility in Scott County, Illinois and three M&R facilities in St. Louis County, Missouri), access roads and other minor aboveground appurtenant facilities. Construction is anticipated to commence in the first quarter of 2018.

In non-agricultural areas, the Project will require 50 feet of permanent easement and 40 feet of temporary workspace (which will revert to the Landowner upon completion of construction activities), a total of 90 feet of construction right-of-way. In agricultural areas, Spire will require 50 feet of permanent easement, 40 feet of temporary workspace and 25 feet of additional temporary workspace; a total of 115 feet of construction right-of-way.

If construction does not commence within two years from the issuance of the FERC's Certificate of Public Convenience and Necessity, the AIMA will be revised, with Spire's input, to reflect the IDOA's most current Pipeline Construction Standards and Policies. This AIMA, and any updated AIMA, will be filed with the FERC by Spire.

The construction standards and policies described below apply to construction activities occurring partially or wholly on privately owned agricultural land. With the exception of Item No. 3, they are not intended to apply to construction activities occurring entirely on public right-of-way, railroad right-of-way, publicly owned land, or privately owned land that is not agricultural

land. Spire will, however, adhere to the construction standards relating to the repair of drain tile when drain tiles are encountered on public highways right-of-way, railroad right-of-way and publicly or privately owned land.

### **Introduction**

Spire will retain qualified professionals on each construction phase of the Project. The qualified professionals may be engineers, soil scientists, agronomists and/or construction and environmental inspectors as appropriate during each phase of the Project. This shall include initial AIMA development, construction, initial restoration, and post-construction monitoring and follow-up restoration. The qualified professionals shall act to ensure that the provisions set forth in this document or in any separate agreement, will be adhered to in good faith by the Spire and by the Project construction contractor(s), and that all agreements protect the resources of both the Landowner and Spire.

The qualified professionals shall assist with the collection and analyzing of site-specific agricultural information gathered for the AIMA development by Spire. This information will be obtained through field review as well as direct contact with affected Landowners and farm operators, local County Soil and Water Conservation Districts (SWCDs), Agricultural Extension Agents and others. Spire shall provide a courtesy copy of the site-specific information to the appropriate local County SWCD(s) any time an AIMA modification is submitted.

Spire shall also retain Agricultural Inspectors that will work with the appropriate onsite Spire Project Inspectors and Project Contractors throughout the construction phase and through other phases as needed. Prior to such selection, the IDOA and Spire shall agree on the bidding process (including compensation). The Agricultural Inspectors will also maintain contact with the affected Landowners and farm Tenants in conjunction with Spire rights-of-way agents, as well as local SWCD personnel concerning farm resources and management matters pertinent to the agricultural operations and the site-specific implementation of the Agreement.

Spire will pay for the cost of the work performed by the Agricultural Inspectors that are, at a minimum, thoroughly familiar with the following:

- This Agreement;
- FERC's Plan and Procedures;
- Pipeline Construction Sequences and Process;
- Aspects of production agriculture, Illinois soils, soil and water conservation, and Farm operations.

The Agricultural Inspector will possess:

- Good oral and written communication skills, and the ability to work closely with the Landowner, Tenants, Spire and Project contractor(s).

Spire agrees that a minimum of one Agricultural Inspector will be assigned per construction (installation) spread.

The Agricultural Inspector(s) shall train all pipeline contractors on the terms of this Agreement and provide a copy of the Agreement to them.

When permitted by law and contract, Spire shall encourage its pipeline contractor(s) to use, where and if available, local drain tile contractors to redesign, reconstruct, and/or repair any subsurface drain tile lines that are affected by the pipeline installation. Often, the local

contractors have installed the Landowner's drain tile system and can have valuable knowledge as to the location, depth of cover, appurtenances, and any other factors affecting the tile operation. The drain tile contractor(s) shall follow the attached construction specifications (Refer to 3.D.).

Unless the easement or other agreement between the Landowner and Spire provides to the contrary, the actions specified in the pipeline standards and construction specifications contained in this AIMA will be implemented in accordance with the conditions listed below.

### **Conditions of the AIMA**

The mitigative actions specified in the construction standards and policies set forth in this document below will be implemented in accordance with the conditions listed below:

- A. All mitigative actions are subject to modification through negotiation by the Landowner and a representative of Spire, provided such changes are negotiated in advance of any construction, maintenance, or repairs.
- B. Spire may negotiate with the Landowner to carry out the mitigative actions that Landowners wish to perform themselves.
- C. All mitigative actions employed by Spire, unless otherwise specified in these construction standards and policies or in an easement negotiated with an individual Landowner, will be implemented within 45 days of completion of the pipeline facilities on any affected property, weather and Landowner permitting. Temporary repairs will be made by Spire during the construction process as needed to minimize the risk of additional property damage that may result from an extended construction time period. If weather delays the completion of any mitigative action beyond the 45 day period, Spire will provide the affected Landowner(s) with a written estimate of the time needed for completion of the mitigative action.
- D. All mitigative actions will extend to associated future construction, maintenance and repairs by Spire.
- E. Spire will provide the IDOA with one set of mailing labels of Landowners and known Tenants on agricultural land, on a county-by-county basis, who are crossed by the proposed pipeline. As the list of affected Landowners and Tenants is updated, Spire will notify the IDOA of any additions or deletions. All labels will be sent to the IDOA upon execution of this AIMA. The IDOA will use the labels for mailing this AIMA to each Landowner and Tenant. Spire shall provide postage reimbursement to the IDOA for mailing to all Landowners.  
  
The IDOA will also provide this AIMA to the County Farm Bureau and SWCDs offices in the affected counties for the purpose of holding Landowner informational meetings.
- F. Every effort will be made by Spire to determine affected Landowners and Tenants along the route of the pipeline. Spire will endeavor to keep the Landowners and Tenants informed of the Project's status, meetings and other factors that may have an impact upon their farming operations.
- G. After construction, Spire will provide the IDOA with "as built" drawings (strip maps) showing the location of all tile lines by survey station encountered in the construction of the pipeline. The drawings and GPS tile line repair coordinates will be provided on a

- county-by-county basis for distribution by the IDOA to the respective County SWCDs for the purpose of assisting Landowners with future drainage needs.
- H. In addition, after all construction is complete, affected Landowners on agricultural land will receive a copy of the drainage tile repairs location map with GPS coordinates identified as the Project crosses their property.
  - I. Prior to the construction of the pipeline, Spire shall provide each Landowner or Landowner's Designate and Tenant with a telephone number and address which can be used to contact Spire, both during and following the completion of construction, regarding the work that was performed on their property or any other construction-related matter. Spire shall respond promptly to Landowner or Landowner's Designate and/or Tenant's telephone calls and correspondence.
  - J. Spire agrees to include this AIMA as part of its submissions to the FERC.
  - K. Spire will request that FERC includes a statement affirming Spire's adherence to the construction standards and policies in any environmental assessment and/or environmental impact statement that may be prepared on the Project.
  - L. Spire will implement all mitigative actions contained in this AIMA to the extent that they do not conflict with the requirements of applicable federal, state and local rules and regulations and other permits and approvals that are obtained by Spire for the Project.
  - M. Each mitigative action contained in this AIMA will be implemented to the extent that such mitigative action is not determined to be unenforceable by reason of the mitigative actions approved by, or other requirements of, the FERC Certificate issued for the Project or other State/Federal agency with permitting authority over the Project.
  - N. A forester with local expertise shall be hired by Spire to appraise the merchantable value of any timber to be cut for construction of the pipeline. The Landowner shall be compensated 100 percent of the value.
  - O. Spire will use good faith efforts to consult with both Landowners and Tenants of a given property in accordance with the terms of this AIMA.
  - P. Spire will incorporate by reference, the terms of this AIMA, in easement agreements executed with Landowners on Agricultural Land in Illinois. However, in the event of a conflict between this AIMA and an easement agreement, the easement agreement will control.

## Definitions

Agricultural Impact Mitigation Agreement (AIMA)	The Agreement between Spire and the Illinois Department of Agriculture described herein.
Agricultural Land	Land used for cropland, hayland, pasture land, managed woodlands, truck gardens, farmsteads, commercial ag-related facilities, feedlots, livestock confinement systems, land on which farm buildings are located, and land in government set-aside programs.
Best Efforts	Diligent and commercially reasonable efforts to achieve a given objective or obligation.
Best Management Practices (BMPs)	Any structural, vegetative or managerial practice used to treat, prevent or reduce soil erosion. Such practices may include, but are not limited to, temporary seeding of exposed soils, construction of retention basins for storm water control and scheduling the implementation of all BMPs to maximize their effectiveness.
Cropland	Land used for growing row crops, small grains, or hay; includes land which was formerly used as cropland, but is currently in a government set-aside program and pastureland comprised of prime farmland.
Drainage Tile/Drain Tile	Artificial subsurface drainage system including, but not limited to, clay and concrete tile, vitrified sewer tile, corrugated plastic tubing, and stone drains.
U.S. Dept. of Energy, Federal Energy Regulatory Commission (FERC)	Federal agency that regulates the transmission and wholesale sale of electricity and natural gas in interstate commerce, and regulates the transportation of oil by pipeline in interstate commerce. FERC also reviews the siting of interstate natural gas pipelines, natural gas storage projects, and liquefied natural gas (LNG) terminals. FERC's scientific, legal, and economic experts evaluate the environmental, cultural, geological, land use, and socioeconomic aspects of the Project. As part of this review, FERC seeks written comments from the public and holds public scoping meetings (when required).
Landowner	Person(s) holding legal title to property on the pipeline route from whom Spire is seeking, or has obtained, a temporary or permanent easement, or any person(s) legally authorized by a Landowner to make decisions regarding the mitigation or restoration of agricultural impacts to such Landowner's property.

Landowner's Designate	Any person(s) legally authorized by a Landowner to make decisions regarding the mitigation or restoration of agricultural impacts to such Landowner's property.
Non-agricultural Land	Any land that is not "Agricultural Land" as defined above.
Parent Material	The unconsolidated mineral or organic material from which the true soil develops. Parent material is located below the subsoil strata and is not a rooting or growing medium. It will be removed from the right-of-way.
Pipeline	The 24-inch diameter natural gas pipeline, related aboveground facilities and appurtenances located in Scott, Greene and Jersey Counties in Illinois, as described in Spire's application to FERC for a Certificate of Public Convenience and Necessity.
Prime Farmland	Agricultural land comprised of soils that are defined by the USDA Natural Resources Conservation Service as being "prime" soils (generally considered the most productive soils with the least input of nutrients and management).
Right-of-way	The permanent easement and temporary workspace Spire acquires and utilizes for the purpose of constructing and operating the pipeline.
Spire	Spire STL Pipeline LLC and any contractor or sub-contractor in the employ of Spire for the purpose of completing construction of the pipeline or any mitigative actions covered by this Agreement.
Spread	Each major segment of project right-of-way where pipeline construction will occur. Spread length for a particular project may vary from a few miles up to ±60 miles.
Surface Drains	Any surface drainage system such as shallow surface field drains, grassed waterways, open ditches, or any other conveyance of surface water.
Tenant	Any person lawfully residing on or leasing/renting of the land.
Topsoil	The uppermost layer of the soil that has the darkest color or the highest content of organic matter, more specifically defined as the "A" horizon. The surface layer of the soil has the darkest color or the highest content of organic matter (as defined in the USDA County Soil Survey and verified with samples as stipulated under 2.A below).



## Construction Standards and Policies

### 1. Pipeline depth

- A. Except for aboveground piping facilities, such as mainline block valves, tap valves, meter stations, etc., the pipeline will be buried with:
  - 1. A minimum of 5 feet of top cover where it crosses cropland.
  - 2. A minimum of 5 feet of topcover where it crosses pasture land or other agricultural land comprised of soils that are classified by the USDA as being prime soils.
  - 3. A minimum of 3 feet of top cover where it crosses pasture land and other agricultural land not comprised of prime soils.
  - 4. A minimum of 3 feet of top cover where it crosses wooded/brushy land.
  - 5. Essentially the same topcover as an existing parallel pipeline, but not less than 5 feet, where the route parallels an existing pipeline within a 100 foot perpendicular offset.
- B. Notwithstanding the foregoing, in those areas where (i) rock in its natural formation and/or (ii) a continuous strata of gravel exceeding 200 feet in length are encountered, the minimum top cover will be 30 inches.
- C. When the pipeline requires weights to keep it from floating, the pipeline will be buried deep enough to maintain the depth of topcover above the weights as specified in 1.A. above.
- D. On agricultural land subject to erosion, Spire will patrol the pipeline right-of-way with reasonable frequency to detect areas of erosion of the top cover. In no instance will Spire knowingly allow the amount of top cover to be less than 36 inches as a result of natural erosion, except as stated in 1.B. above.

### 2. Topsoil Replacement

- A. The topsoil depth shall be determined by a properly qualified soil scientist or soil technician (or qualified Agricultural Inspector) who will set stakes or flags every 200 feet along the right-of-way identifying the depth of topsoil to be removed.
- B. The actual depth of the topsoil, not to exceed 36 inches, will first be stripped from the area to be excavated above the pipeline and from the adjacent subsoil storage area. The topsoil will be stored in a windrow parallel to the pipeline trench in such a manner that it will not become intermixed with subsoil materials.
- C. All subsoil material that is removed from the trench will be placed in a second windrow parallel to the pipeline trench that is separate from the topsoil windrow.
- D. Parent material is not rooting material and should never be spread over the right-of way. Any parent material encountered with excavation shall be separated and hauled off the right-of-way and disposed of as agreed by Spire and the Landowner.

- E. In backfilling the trench, the stockpiled subsoil material will be placed back into the trench before replacing the topsoil.
- F. Refer to Items No. 5.A. through 5.D. for procedures pertaining to rock removal from the subsoil and topsoil.
- G. Refer to Items No. 7.A. through 7.F. for procedures pertaining to the alleviation of compaction of the topsoil.
- H. The topsoil must be replaced so that after settling occurs, the topsoil's original depth and contour (with an allowance for settling) will be restored. The same shall apply where excavations are made for road, stream, drainage ditch, or other crossings. In no instance will the topsoil materials be used for any other purpose.

### **3. Repair of Damaged Tile Lines**

If underground drainage tile is damaged by the pipeline's construction, it will be repaired in a manner that assures the tile line's proper operation at the point of repair. The following standards and policies shall apply to the tile line repair:

- A. Spire will endeavor to locate all tile lines within the right-of-way prior to the pipeline's installation so repairs can be made if necessary. Spire will contact affected Landowners/ Tenants for their knowledge of tile line locations prior to the pipeline's installation. All identified tile lines will be staked or flagged prior to construction to alert construction crews to the possible need for tile line repairs. If previously unidentified, tile lines that are encountered and cut during grading or trenching activities will be flagged at that time.
- B. All tile lines that are damaged, cut, or removed shall be staked or flagged with the stakes or flags placed in such a manner they will remain visible until the permanent repairs are completed.
- C. If water is flowing through any damaged tile line, the tile line will be immediately and temporarily repaired until such time that permanent repairs can be made. If the tile lines are dry and water is not flowing, temporary repairs are not required if the permanent repairs can be made within 14 days of the time damage occurred; however, the exposed tile lines will be screened or otherwise protected to prevent the entry of foreign materials, small mammals, etc. into the tile lines.
- D. Where tile lines are severed by the pipeline trench, repairs shall be made using the IDOA Tile Line Repair Drawings, Temporary and Permanent, 2015 (see Figures 1 and 2) or the Tile Bridge Permanent Repair.
- E. There will be a minimum of one foot of separation (or a separation to be specified by Spire during the time of construction that may exceed, but will not be less than one foot, between the tile line and the pipeline whether the pipeline passes over or under the tile line.
- F. The original tile line alignment and gradient shall be maintained. A laser transit shall be used to ensure the proper gradient is maintained. A laser operated tiling machine shall be used to install or replace tiling segments of 100 linear feet or more.

- G. Before completing permanent tile repairs, all tile lines will be probed or examined by other suitable means on both sides of the trench for their entire length within any work areas to check for tile that might have been damaged by vehicular traffic or construction equipment. If tile lines are found to be damaged, they must be repaired so they operate as well after construction as before the construction began.
- H. All permanent tile line repairs must be made within 14 days of the pipeline being laid in the trench on the Landowner's property, weather and soil conditions permitting.
- I. Following completion of the pipeline, Spire will be responsible for correcting all tile line repairs that fail due to pipeline construction, provided those repairs were made by Spire. Spire will not be responsible for tile line repairs that Spire pays the Landowner to perform.
- J. Spire will use good faith efforts to consult with both Landowners and Tenants of a given property as appropriate.

#### **4. Installation of Additional Tile Lines**

- A. Spire shall be responsible for installing such additional drainage tile and other drainage measures as are necessary to properly drain wet areas on the permanent and temporary easements caused by the construction and/or existence of the pipeline.
- B. Where the pipeline's route parallels an existing pipeline within a 200-foot perpendicular offset, Spire shall be responsible for installing tile and/or other drainage measures, as necessary, to properly drain the area between the two pipelines to the extent the wet areas between the pipelines are caused by the construction and/or existence of the pipeline.
- C. It is presumed that any wet areas located in permanent and temporary easements and/or between the two parallel pipelines are caused by the construction and/or existence of the new pipeline unless Spire can prove that the construction and/or existence of the new pipeline is not the cause of the wet areas.

#### **5. Rock Removal**

The following rock removal procedures only pertain to rocks found in the uppermost 42 inches of soil, the common freeze zone in Illinois.

- A. Before replacing any topsoil, all rocks greater than 3 inches in any dimension will be removed from the surface of all exposed subsoil and from all subsoil that is replaced back in the trench.
- B. As the topsoil is replaced, all rocks greater than 3 inches in any dimension will be removed from the topsoil.
- C. If trenching, blasting, or boring operations are required through rocky terrain, suitable precautions will be taken to minimize the potential for oversized rocks to become interspersed with adjacent soil material.
- D. Rocks and soil containing rocks removed from the subsoil areas, topsoil, or from any excavations, will be hauled off the Landowner's premises or disposed of on the

Landowner's premises at a location that is mutually acceptable to the Landowner and Spire. Haul off and/or disposal locations cannot conflict with Spire's FERC Certificated workspace allowance.

**6. Removal of Construction Debris**

All construction-related debris and material that are not an integral part of the Project will be removed from the Landowner's property. Such material to be removed would include litter generated by the construction crews. Litter shall be removed daily.

**7. Compaction, Rutting, Fertilization, Liming**

- A. After the topsoil has been replaced, all areas that were traversed by vehicles and construction equipment will be ripped at least 18 inches deep and all pasture and woodland will be ripped at least 12 inches deep. The existence of tile lines or underground utilities may necessitate less depth. The entire right-of-way will then be disked. Decompaction shall be conducted according to the guideline provided in Appendices A and B.
- B. When done correctly with the proper equipment and soil conditions, ripping across any agricultural land should only take one pass. Additional passes should only be conducted if the previous pass did not sufficiently shatter the soil.
- C. All ripping and disking will be done at a time when the soil is dry enough for normal tillage operations to occur on undisturbed farmland adjacent to the areas to be ripped.
- D. Spire will restore all rutted land within the right-of-way to its original condition.
- E. The cost of applying fertilizer, manure, and/or lime will be included in the damages paid to the Landowner, thereby allowing the Landowner to apply the appropriate type and amounts of fertilizer, manure, and/or lime as needed depending on the crops contemplated and the construction schedule.
- F. If there is any dispute between the Landowner and Spire as to what areas need to be ripped, the depth at which compacted areas should be ripped, or the necessity or rates of lime and fertilizer application, the appropriate County SWCD's opinion shall be considered by Spire and the Landowner.

**8. Land Leveling**

- A. Following the completion of the pipeline, Spire will restore the right-of-way to its original pre-construction elevation and contour should uneven settling occur or surface drainage problems develop as a result of pipeline construction.
- B. Spire will provide the Landowners with a telephone number and address that may be used to alert Spire of the need to perform additional land leveling services.
- C. If, in the future, uneven settling occurs or surface drainage problems develop as a result of the pipeline construction, Spire will provide such land leveling services within 45 days of a Landowner's written notice, weather and soil conditions permitting or at a time agreed upon by the Landowner and Spire.

- D. If there is any dispute between the Landowner and Spire as to what areas need additional land leveling beyond that which is done at the time of construction, it shall be Spire's responsibility to disprove the Landowner's claim that additional land leveling is warranted.

**9. Construction During Wet Weather**

Except as provided below, construction activities are not allowed on farmland where normal farming operations, such as plowing, disking, planting or harvesting, cannot take place due to excessively wet soils. Wet weather conditions are to be determined on a field by field basis and not for the project as a whole.

- A. Construction activities on prepared surfaces, surfaces where topsoil and subsoil have been removed, heavily compacted in preparation, or otherwise stabilized (e.g. through cement mixing) may occur at the discretion of the Company in wet weather conditions.
- B. Construction activities on unprepared surfaces will be done only when work will not result in excessive rutting creating an excessive mixing of subsoil and topsoil. Determination as to the potential of subsoil and topsoil mixing will be in consultation with the underlying Landowner, or, if approved by the Landowner, his/her designated Tenant.

**10. Backfill Profile and Trench Crowning**

- A. In all agricultural land areas, trench crowning shall occur during the trench backfilling operation using subsoil materials over the trench to allow for trench settling, to be followed by topsoil replacement. Due to the increased elevation of the crown compared to the rest of the right-of-way, surface drainage across the trench may be hindered until the crown has settled completely.
- B. Surface drainage should not be permanently blocked or hindered in any way. If excess soil is encountered, it will be removed offsite to prevent ridging, unless the Landowner and Spire agree otherwise. Adding additional soil to the crown over the trench in excess of that required for settlement will not be permitted. In areas where minor trench settling occurs after topsoil spreading, land leveling or imported topsoil shall be used to fill each depression. In areas where major trench settling occurs after topsoil spreading, and land leveling cannot be utilized; imported topsoil shall be used to fill each depression of significant depth. Topsoil from the adjacent agricultural land outside of the construction footprint shall not be used to fill the depressions.
- C. In agricultural areas where the materials excavated during trenching are insufficient in quantity to meet backfill requirements, the soil from any agricultural land adjacent to the trench and construction zone shall not be used as either backfill or surface cover material.

Under no circumstances shall any topsoil materials be used for pipe padding material or trench backfill. In situations where imported soil materials are employed for backfill on agricultural lands, such material shall be of similar texture and quality to the existing soils on site. Imported soils should be free from noxious weeds and other pests to the extent possible.

- D. Parent material consists of the C horizon and may or may not consist of materials similar to those from which the A and B horizons developed. It may be blue clay; it may include rocks or sand. It will not promote or support viable plant growth. Under no circumstances is this material to be placed in the trench above the pipe or spread across the easement as part of the leveling material unless agreed to by the Landowner. Parent material is to be stored separated away from the topsoil and subsoil piles. It will be removed from the right-of-way.

#### **11. Prevention of Soil Erosion**

- A. Spire will work with Landowners to prevent excessive erosion on right-of-way that has been disturbed by construction. Reasonable methods will be implemented to control erosion. This is not a requirement, however, if the land across which the pipeline is constructed is bare cropland that the Landowner intends to leave bare until the next crop is planted.
- B. If the Landowner and Spire cannot agree upon a reasonable method to control erosion on the right-of-way, the recommendations of the appropriate County SWCD shall be considered by Spire and the Landowner.

#### **12. Repair of Damaged Soil Conservation Practices**

All soil conservation practices (such as terraces, grassed waterways, etc.), which are damaged by the pipeline's construction, will be restored to reflect at least a substantially similar condition to its pre-construction condition in consultation with the local SWCD. And in accordance with USDA Natural Resources Conservation Service standards.

- A. Spire will repair or pay the Landowner to repair any soil conservation practices (such as terraces, grassed waterways, etc.), which are damaged by the pipeline's construction.
- B. If Spire is responsible for repairing any damaged soil conservation practices, the repairs will be made in accordance with the specifications of the local SWCD.
- C. The work set forth in this section will be done within 45 days, weather and Landowner permitting, after the pipeline has been constructed.

#### **13. Damages to Private Property**

- A. Spire will reasonably compensate Landowners for any construction-related damages caused by Spire that occur on or off of the established pipeline right-of-way.
- B. Compensation for damages to private property caused by Spire shall extend beyond the initial construction of the pipeline, to include those damages caused by Spire during future construction, operation, maintenance, and repairs relating to the pipeline.
- C. Spire will reimburse Landowner, on a timely basis, for all agricultural production inputs (fertilizers of all types and kinds) needed to restore crop productivity to the right-of-way, the temporary work space, or any other portion of Landowner's property where crop yields are diminished by reason of the construction, repair, maintenance and inspection activities of Spire. This shall be a continuing obligation of Spire until crop growth and vigor are similar to adjacent undisturbed portions of the same field, in accordance with Spire's crop loss payments as part of each Landowner easement

agreement. Also, Spire shall make available to Landowner the name and contact information of a person acting on behalf of Spire with whom the Landowner can communicate information with regard to diminished crop yields, and need for reimbursement of cost of agricultural inputs. That person will have a background related to soil productivity and crop production.

**14. Clearing of Trees and Brush from the Easement**

- A. If trees are to be removed from the right-of-way, Spire will consult with the Landowner to determine if there are trees of commercial or other value to the Landowner.
- B. If there are trees of commercial or other value to the Landowner, Spire will allow the Landowner the right to retain ownership of the trees with the disposition of the trees to be negotiated prior to the commencement of land clearing. Spire's ability to transport and/or stockpile trees will be restricted to the confines of the FERC Certificated workspace.
- C. Unless otherwise restricted by federal, state or local regulations, Spire will follow the Landowner's desires regarding the removal and disposal of trees, brush, and stumps of no value to the Landowner by burning, burial, etc., or complete removal from any affected property.

**15. Interference with Irrigation Systems**

- A. If the pipeline and/or temporary work areas intersect an operational (or soon to be operational) spray irrigation system, Spire will establish with the Landowner an acceptable amount of time the irrigation system may be out of service.
- B. If, as a result of pipeline construction activities, an irrigation system interruption results in crop damages, either on the pipeline right-of-way or off the right-of-way, the Landowner will be reasonably compensated for all such crop damages that are attributed to the system interruption.
- C. If it is feasible and mutually acceptable to Spire and the Landowner, temporary measures will be implemented to allow an irrigation system to continue to operate across land on which the pipeline is also being constructed.

**16. Ingress and Egress Routes**

Prior to the pipeline's installation, Spire and the Landowner will reach a mutually acceptable agreement on the route that will be utilized for entering and leaving the pipeline right-of-way should access to the right-of-way not be practical or feasible from adjacent segments of the pipeline right-of-way or from public highway or railroad right-of-way. Access routes on non-public travel ways will be restricted to the confines of the FERC Certificated workspace.

**17. Temporary Roads**

- A. The location of temporary roads to be used for construction purposes will be negotiated with the Landowner and would be restricted to the confines of the FERC Certificated workspace.

- B. The temporary roads will be designed to not impede surface drainage and will be built to minimize soil erosion on or near the temporary roads.
- C. Upon abandonment, temporary roads may be left intact through mutual agreement of the Landowner and Spire unless otherwise restricted by federal, state, or local regulations.
- D. If the temporary roads are to be removed, the rights-of-way upon which the temporary roads are constructed will be returned to their previous use(s) and restored to equivalent condition(s) as existed prior to their construction. All temporary access roads that are removed shall be ripped to a depth of 18 inches. All ripping will be done consistent with Items 7.A. through 7.F.

**18. Weed Control**

- A. On any right-of-way over which Spire has jurisdiction as to its surface use, (i.e., valve sites, metering stations, etc.), Spire will provide for weed control in a manner that prevents the spread of weeds onto adjacent lands used for agricultural purposes. Spraying will be done by a pesticide applicator that is appropriately licensed for doing such work in the State of Illinois.
- B. Spire will be responsible for reimbursing all reasonable costs incurred by owners of land adjacent to surface facilities when the Landowners must control weeds on their land which can be determined to have spread from land accommodating pipeline surface facilities, should Spire fail to do so after being given written notice and a 45-day opportunity to respond.

**19. Pumping of Water from Open Trenches**

- A. In the event it becomes necessary to pump water from open trenches, Spire will pump the water in a manner that will avoid damaging adjacent agricultural land, crops, and/or pasture. Such damages include, but are not limited to, inundation of crops for more than 24 hours, deposition of sediment in ditches and other water courses, and the deposition of subsoil sediment and gravel in fields and pastures.
- B. If it is impossible to avoid water-related damages as described in Item 19.A. above, Spire will reasonably compensate the Landowners for the damages or will correct the damages so as to restore the land, crops, pasture, water courses, etc. to their pre-construction condition.
- C. All pumping of water shall comply with existing drainage laws, local ordinances relating to such activities, and provisions of the Clean Water Act.

**20. Aboveground Facilities**

Locations for aboveground facilities shall be selected in a manner so as to be as unobtrusive as reasonably possible to ongoing agricultural activities occurring on the land adjacent to the facilities. First priority shall be made to locating aboveground facilities on right-of-way that is not used as cropland. If this is not feasible, such facilities shall be located so as to incur the least hindrance to the adjacent cropping operations (i.e., located in field corners or areas where at least one side is not used for cropping purposes).



**21. Advance Notice of Access to Private Property**

- A. Spire will provide the Landowner or Tenant with a minimum of 24 hours prior notice before accessing his/her property for the purpose of constructing the pipeline.
- B. Prior notice shall first consist of a personal contact or a telephone contact, whereby the Landowner or Tenant is informed of Spire's intent to access the land. If the Landowner or Tenant cannot be reached in person or by telephone, Spire will mail or hand deliver to the Landowner or Tenant's home a dated, written notice of Spire's intent. The Landowner or Tenant need not acknowledge receipt of the written notice before Spire can enter the Landowner's property.

**22. Reporting of Inferior Agricultural Impact Mitigation Work**

No later than 45 days prior to the commencement of the pipeline construction across a Landowner's property, Spire will provide the Landowner with a toll-free number the Landowner can call to alert Spire should the Landowners observe inferior agricultural impact mitigation work which is being done or has been carried out on his/her property.

**23. Indemnification**

Spire will indemnify all owners and farm tenants of agricultural land upon which such pipeline is installed, their heirs, successors, legal representatives, assigns (collectively "Indemnitees"), from and against all claims by third parties losses incurred thereby, and reasonable expenses, resulting from or arising out of personal injury, death, injury to property, or other damages or liabilities of any sort related to the design, laying, maintenance, removal, repair, use or existence of such pipeline, whether heretofore or hereafter laid, including damages caused by such pipeline or any of its appurtenances and the leaking of its contents, except where claims, injuries, suits, damages, costs, losses, and expenses are caused by the negligence or intentional acts, or willful omissions of such Indemnitees and/or their invitees, including contractors, provided further that such Indemnitees shall tender any such claim as soon as possible upon receipt of notice thereof to Spire. For activities undertaken by the Indemnitees and/or invitees near the pipeline, failure by such Indemnitees and/or invitees to call the **Illinois 811, Call Before You Dig** line shall be deemed negligence if the pipeline is not clearly marked by signs.

**24. General Monitoring and Remediation**

This Plan establishes construction and restoration guidelines to limit adverse effects to agricultural resources and to return the affected lands to productive agricultural use with a level of production consistent with that of the lands immediately adjacent to the right-of-way. Post construction and restoration situations may occur as a result of the pipeline construction which requires further restoration or corrective activities. These areas potentially requiring further restoration or corrective activities will be brought to Spire's attention through Landowner or Tenant contacts with Spire right-of-way staff or as a result of Spire's monitoring of the pipeline right-of-way in accordance with the FERC Plan and Procedures.

**Concurrence of the Parties to this AIMA**

The Illinois Department of Agriculture and Spire STL Pipeline LLC concur that this AIMA is the complete instrument governing the mitigation of agricultural impacts that may result from the construction of the natural gas pipeline in Scott, Greene and Jersey Counties within the State of Illinois.

The effective date of this AIMA commences on the date of execution.

**State of Illinois  
DEPARTMENT OF AGRICULTURE**

  
\_\_\_\_\_  
(signature)  
Raymond Poe, Director

Illinois Department of Agriculture  
63101 State Fairgrounds  
P.O. Box 19281  
Springfield, IL 62794-9281

  
\_\_\_\_\_  
(signature)  
By Craig Sondgeroth, General Counsel

801 E. Sangamon Avenue  
Springfield, IL 62702

March 15, 2017

**SPIRE STL PIPELINE LLC**

  
\_\_\_\_\_  
(signature)  
Castor Armesto, General Counsel

700 Market Street  
St. Louis, Missouri 63101

March 3, 2017

## Appendix A.

### Guidelines for Conducting Proper and Successful Decompaction

1. Decompaction is required when all three conditions apply.
  - A. the area has been trafficked or traversed by vehicles or construction equipment, and
  - B. the soil penetrometer readings are 300 psi or greater, and
  - C. The soil strength (psi) in the right-of-way area is greater than that of the non-trafficked area.
2. An Environmental and/or Agricultural Inspector (AI), with experience and training in the proper identification of compacted soil and operation methods of deep decompaction tools is required to observe the daily operation of the ripper/subsoiler to ensure the conditions are appropriate for decompaction efforts and that the proper equipment is utilized and that equipment is set-up and operated correctly.
3. To achieve the most effective shatter of the compacted soil the following guidelines have been established:
  - A. Conduct ripping when the soil is dry. Follow the "Soil Plasticity Test Procedures" detailed in Appendix B to determine if soil conditions are adequately dry to conduct decompaction efforts.
  - B. Deep ripping shall be conducted using a ripper or subsoiling tool with a shank length of no less than 18 inches and a shank spacing of approximately the same measurement as the shank length.
  - C. Use a ripper with a knife length of no less than 2 inches more than the desired depth of decompaction.
  - D. To best promote revegetation and restore crop production, a total depth of 30 or more inches of soil (topsoil plus subsoil) is required.
  - E. The minimum depths of decompaction stated above in 3.D. are required where possible. A safe distance from sub-surface structures (tile drains, pipelines, buried utilities, bedrock, etc.) must be maintained at all times. Where such structures exist, a lesser depth of decompaction will be required to prevent damage to equipment and the structures as well as to maintain a safe work environment. The allowable decompaction depth in these instances will be determined on a site by site basis.
  - F. When the knives are in the soil to the desired depth, the tongue of the ripper should be parallel to the surface of the ground.
  - G. Select a tractor that has enough horsepower to pull the ripper at a speed of 1.5 to 2 mph and whose footprint is of equal or lesser width than the ripper. Tracked equipment is preferred and typically required to achieve this criteria.
  - H. The ripper shanks should not create ruts, channels, or mixing of the sub-soil with topsoil. A speed of 1.5 to 2 mph is recommended to minimize the risk of rutting and soil mixing. The ideal operating speed can vary with soil characteristics, tractor and ripping tool used. An excessive travel speed will often increase mixing of soil horizons.
  - I. When the equipment is set up and operated correctly, the ripper should create a wave across the surface of the ground as it lifts and drops the soil.

- J. Make one ripping pass through the compacted area. Using a penetrometer, the AI will measure the PSI between the ripped knife tracks to determine if the single ripping pass was successful. Additional passes should only be used where needed as they may reduce the effectiveness of the ripping by recompacting the soil shattered in the previous pass.
- K. If the first pass does not successfully decompact the soil, additional passes will be needed. Should multiple passes of the ripper be needed to achieve decompaction between the knives tracks of the ripping tool, the subsequent passes should be positioned so the knife tracks from the previous pass are split by the second pass. If three or more passes have been made and sufficient decompaction has not yet been achieved the AI may choose to halt further decompaction efforts in that area until conditions improve or better methods are determined.
- L. Following ripping, all stone and rock three or more inches in size which has been lifted to the surface shall be collected and removed from agricultural areas.
- M. After ripping has been conducted, do not allow unnecessary traffic on the ripped area.
- N. In agricultural lands and croplands that will not be replanted to vegetation by the Company, recommend to landowners to plant a cover crop (cereal rye, clover, alfalfa, tillage radish, turnips, etc.) following decompaction. Reduced compaction created by the ripper pass will not remain over time without subsequent root penetration. Root penetration into the shattered soil is necessary to establish permanent stabilized channels to conduct air and water into the soil profile. Two good sources for landowner cover crop education are <http://www.mccc.msu.edu/CCinfo/cropbycrop.html> and <http://mcccdev.anr.msu.edu/>. For local expertise, consult with your county's Soil and Water Conservation District /USDA Natural Resource Conservation Service (NRCS) office for cover crop selection and compliance with NRCS planting deadlines.

60415

## Appendix B.

### Soil Plasticity Test Procedures

The Agricultural Inspector will test the consistency of the surface soil to a depth of approximately 4 to 8 inches using the Field Plasticity Test procedure developed from the *Annual Book of ASTM Standards, Plastic Limit of Soils* (ASTM D-4318).

1. Pull a soil plug from the area to be tilled, moved, or trafficked to a depth of 4-8 inches.
2. Roll a portion of the sample between the palms of the hands to form a wire with a diameter of one-eighth inch.
3. The soil consistency is:
  - A. Tillable (able to be worked) if the soil wire breaks into segments not exceeding  $\frac{3}{8}$  of an inch in length.
  - B. Plastic (not tillable) if the segments are longer than  $\frac{3}{8}$  of an inch before breaking.
4. This Procedure is to be used to aid in determining when soil conditions are dry enough for construction activities to proceed.
5. Once the soil consistency has been determined to be of adequate dryness, the plasticity test is not required again until the next precipitation event.

FIGURE 1.

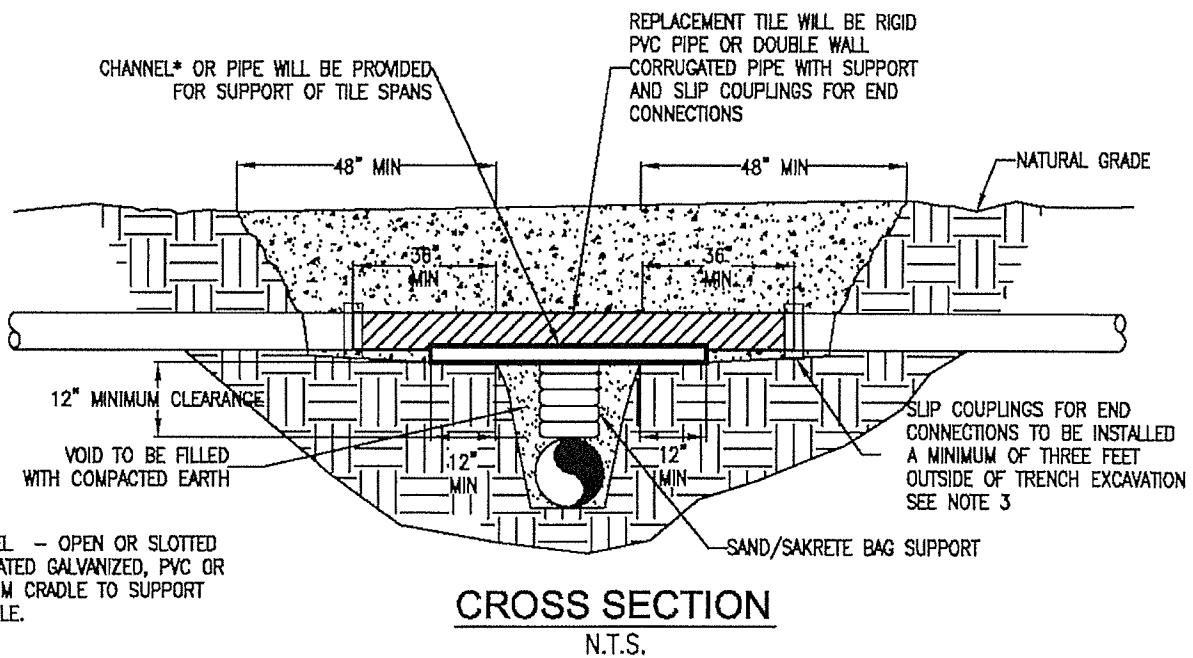
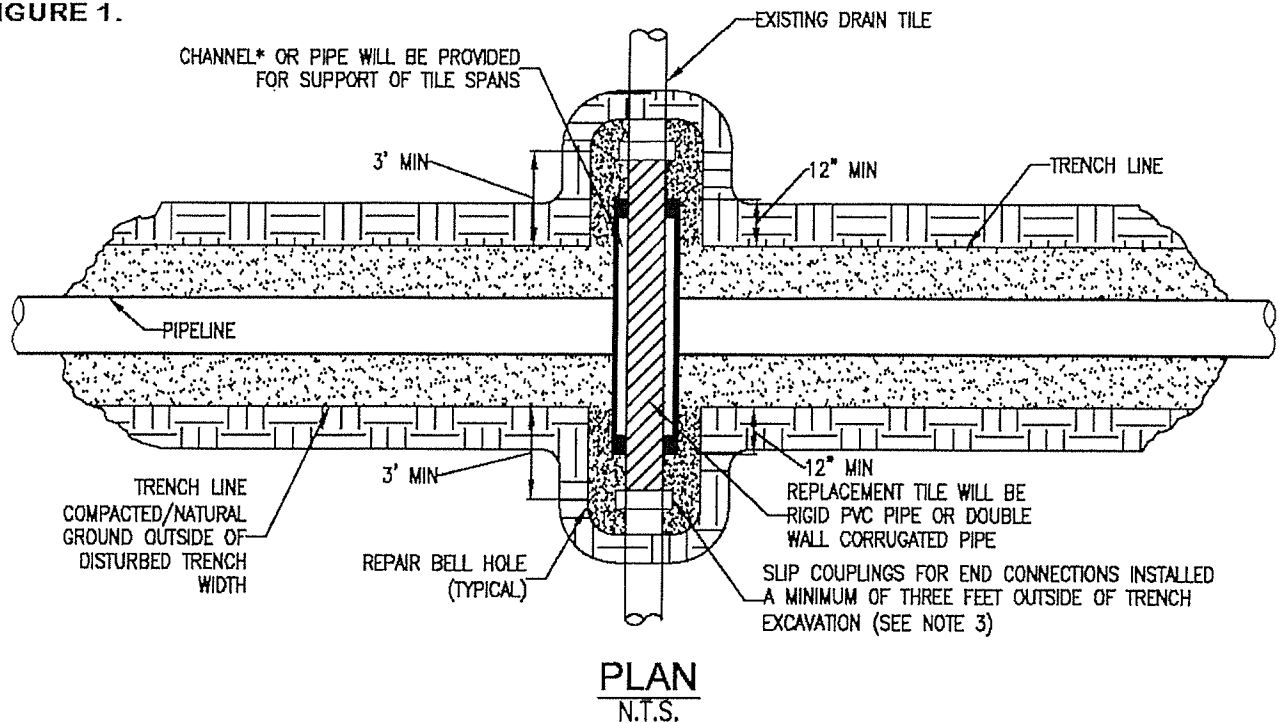

\*CHANNEL - OPEN OR SLOTTED CORRUGATED GALVANIZED, PVC OR ALUMINUM CRADLE TO SUPPORT DRAIN TILE.

**NOTE:**

1. IMMEDIATELY REPAIR TILE IF WATER IS FLOWING THROUGH TILE AT TIME OF TRENCHING. IF NO WATER IS FLOWING AND TEMPORARY REPAIR IS DELAYED, OR NOT MADE BY THE END OF THE WORK DAY, A SCREEN OR APPROPRIATE 'NIGHT CAP' SHALL BE PLACED ON OPEN ENDS OF TILE TO PREVENT ENTRAPMENT OF ANIMALS ETC.
2. CHANNEL OR PIPE (OPEN OR SLOTTED) MADE OF CORRUGATED GALVANIZED PIPE, PVC OR ALUMINUM WILL BE USED FOR SUPPORT OF DRAIN TILE SPANS.
3. INDUSTRY STANDARDS SHALL BE FOLLOWED TO ENSURE PROPER SEAL OF REPAIRED DRAIN TILES.

**TEMPORARY DRAIN TILE REPAIR**

FIGURE 2.

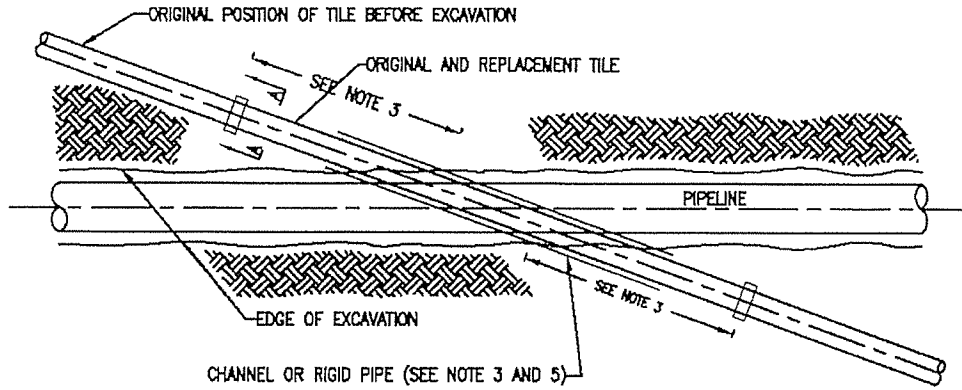

**PLAN VIEW**

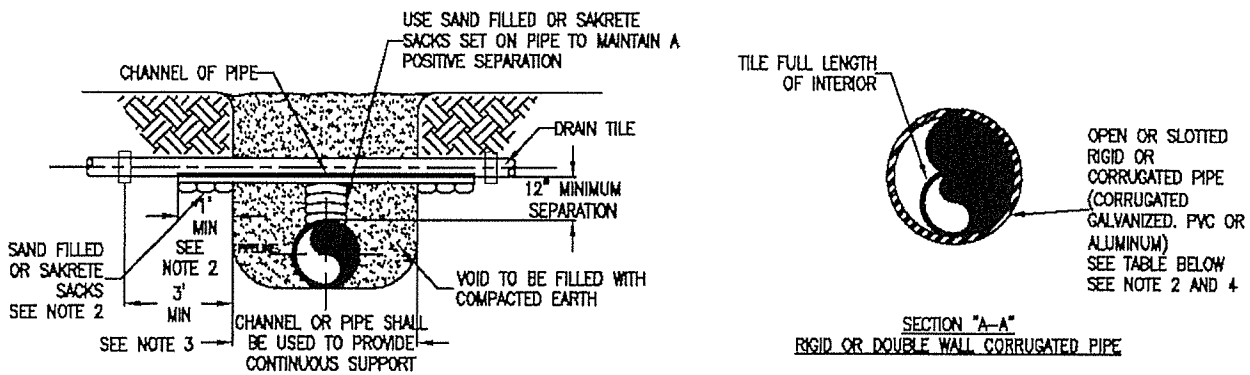

**END VIEWS**

MINIMUM SUPPORT TABLE			
TILE SIZE	CHANNEL SIZE	PIPE SIZE	
3"	4" @ 5.4 #11	4"	STD. WT.
4"-5"	5" @ 6.7 #11	6"	STD. WT.
8"-9"	7" @ 9.8 #11	9"-10"	STD. WT.
10"	10" @ 15.3 #11	12"	STD. WT.

**NOTE:**

- TILE REPAIR AND REPLACEMENT SHALL MAINTAIN ORIGINAL ALIGNMENT GRADIENT AND WATER FLOW TO THE GREATEST EXTENT POSSIBLE. IF THE TILE NEEDS TO BE RELOCATED, THE INSTALLATION ANGLE MAY VARY DUE TO SITE SPECIFIC CONDITIONS AND LANDOWNER RECOMMENDATIONS.
- 1'-0" MINIMUM LENGTH OF CHANNEL OR RIGID PIPE (OPEN OR SLOTTED CORRUGATED GALVANIZED, PVC OR ALUMINUM CRADLE) SHALL BE SUPPORTED BY UNDISTURBED SOIL, OR IF CROSSING IS NOT AT RIGHT ANGLES TO PIPELINE, EQUIVALENT LENGTH PERPENDICULAR TO TRENCH. SHIM WITH SAKRETE, OR SAND BAGS TO UNDISTURBED SOIL FOR SUPPORT AND DRAINAGE GRADIENT MAINTENANCE (TYPICAL BOTH SIDES).
- DRAIN TILES WILL BE PERMANENTLY CONNECTED TO EXISTING DRAIN TILES A MINIMUM OF THREE FEET OUTSIDE OF EXCAVATED TRENCH LINE USING INDUSTRY STANDARDS TO ENSURE PROPER SEAL OF REPAIRED DRAIN TILES INCLUDING SLIP COUPLINGS.
- DIAMETER OF RIGID PIPE SHALL BE OF ADEQUATE SIZE TO ALLOW FOR THE INSTALLATION OF THE TILE FOR THE FULL LENGTH OF THE RIGID PIPE.
- OTHER METHODS OF SUPPORTING DRAIN TILE MAY BE USED IF ALTERNATE PROPOSED IS EQUIVALENT IN STRENGTH TO THE CHANNEL/PIPE SECTIONS SHOWN AND IF APPROVED BY COMPANY REPRESENTATIVES AND LANDOWNER IN ADVANCE. SITE SPECIFIC ALTERNATE SUPPORT SYSTEM TO BE DEVELOPED BY COMPANY REPRESENTATIVES AND FURNISHED TO CONTRACTOR FOR SPANS IN EXCESS OF 20', TILE GREATER THEN 10" DIAMETER, AND FOR "HEADER" SYSTEMS.
- ALL MATERIAL TO BE FURNISHED BY CONTRACTOR.
- PRIOR TO REPAIRING TILE, CONTRACTOR SHALL PROBE LATERALLY INTO THE EXISTING TILE TO FULL WIDTH OF THE RIGHTS OF WAY TO DETERMINE IF ADDITIONAL DAMAGE HAS OCCURRED. ALL DAMAGED/DISTURBED TILE SHALL BE REPAIRED AS NEAR AS PRACTICABLE TO ITS ORIGINAL OR BETTER CONDITION.

**PERMANENT DRAIN TILE REPAIR**



# TILE BRIDGE - PERMANENT TILE REPAIR

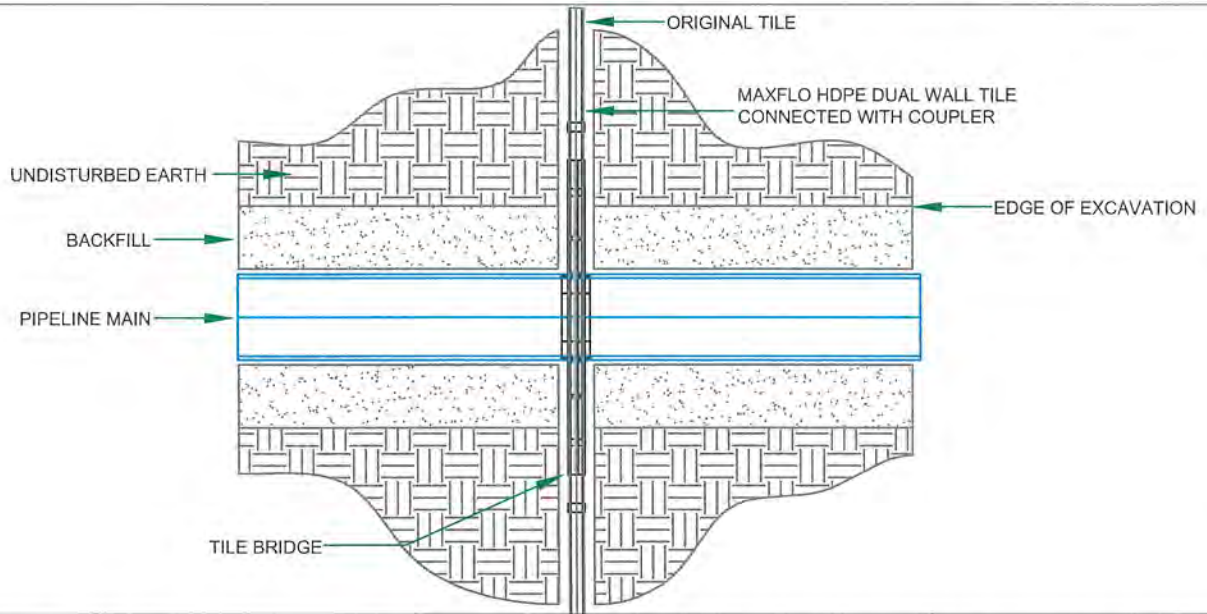
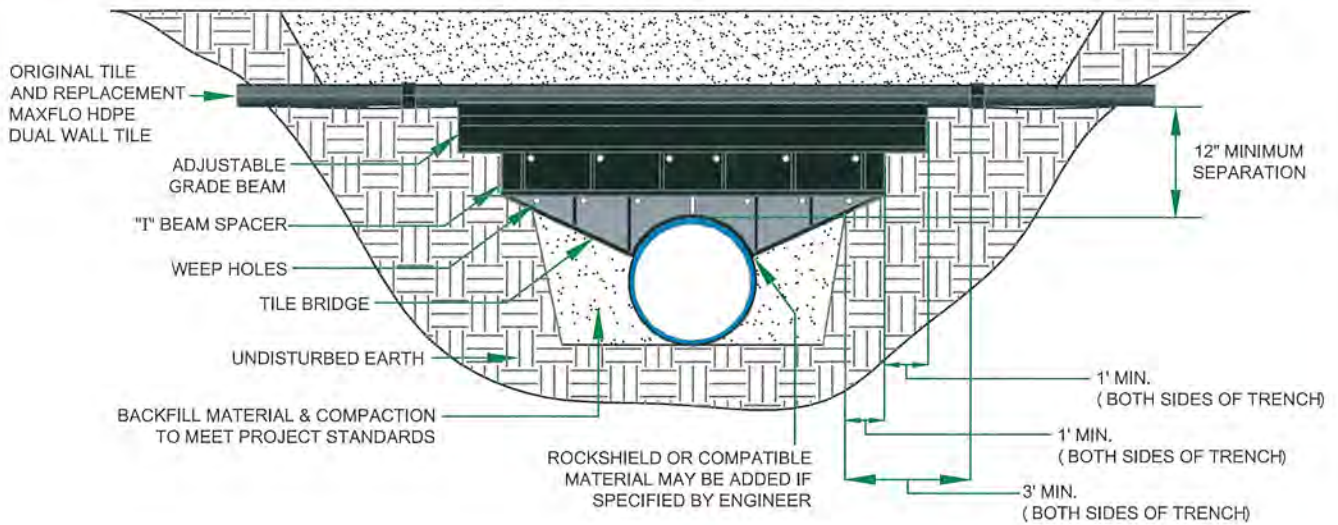

**NOTES:**

1. TILE REPAIR AND REPLACEMENT SHALL CROSS PERPENDICULAR TO THE PIPELINE WHILE MAINTAINING GRADIENT AND FLOW. WATER FLOW MUST BE EQUAL TO OR GREATER THAN ORIGINAL TILE CAPACITY. THE MINIMUM RECEIVING TILE SIZE REQUIRED FOR THE REPAIR SHALL BE 4" DUAL WALL WHEN CONNECTING TO 2", 3" OR 4" SINGLE WALL FIELD TILE AND 6" DUAL WALL WHEN CONNECTING TO 5" AND 6" SINGLE WALL FIELD TILE AND SO ON. ALL RECEIVING TILE SHALL BE DUAL WALL PERFORATED HDPE TUBING AND APPURTENANCES.
2. THE TILE BRIDGE SUPPORTING STRUCTURE SHALL PROVIDE A MINIMUM OF 1 LF SUPPORT INTO UNDISTURBED SOIL IN EACH TRENCH WALL. EACH ADDITIONAL SUPPORTING STRUCTURE SECTION SHALL ALSO PROVIDE A MINIMUM OF 1 LF SUPPORT INTO UNDISTURBED SOIL, INCLUDING ADJUSTABLE GRADE BEAM (WHICH INCLUDES "Y" SUPPORT STRUCTURE FOR PIPE) AND REPLACEMENT HDPE DUAL WALL. IN LOOSER, LESS STRUCTURED SOILS MORE PRONE TO SLOUGHING OFF, THESE SUPPORT DISTANCES MAY NEED TO BE INCREASED. REPLACEMENT HDPE DUAL WALL MAY BE ZIP TIED TO THE "Y" SECTION OF THE ADJUSTABLE GRADE BEAM. THE "Y" SECTION OF ADJUSTABLE GRADE BEAM SHALL SUPPORT HDPE DUAL WALL TO ASTM F449 STANDARDS. SPACER BEAMS MAY BE UTILIZED IF GREATER ELEVATION IS NEEDED BETWEEN THE TILE BRIDGE AND ADJUSTABLE GRADE BEAM TO MAINTAIN PROPER LINE AND GRADE. IF OVER DIGGING INTO THE UNDISTURBED SOIL INTENDED TO SUPPORT THE STRUCTURE OCCURS DURING INSTALLATION OF THE SUPPORTING STRUCTURE, THIS OVER DIG MAY BE FILLED WITH SAND FILLED OR SAKRETE BAGS PROVIDED THEY FIRMLY ABUT ADDITIONAL BAGS AND THE SIDEWALL OF THE TRENCH. IF THE TILE MUST BE RELOCATED, THE INSTALLATION ANGLE SHALL BE PERPENDICULAR TO THE PIPELINE DIRECTION.
3. THE DRAIN TILE REPAIR SECTION WILL BE PERMANENTLY CONNECTED TO THE EXISTING DRAIN TILE A MINIMUM OF 1 LF OUTSIDE OF THE UPPERMOST SUPPORTING STRUCTURE USING INDUSTRY STANDARDS TO ENSURE PROPER SEAL OF REPAIRED DRAIN TILES.
4. OTHER METHODS OF PERMANENT DRAIN TILE REPAIR SUPPORTS MAY BE USED IF THE PROPOSED METHOD IS OF EQUAL OR GREATER STRENGTH THAN DETAILED ABOVE. ANY ALTERNATE METHODS, INCLUDING "TIE IN" AREAS OR OTHER AREAS REQUIRING LONGER SPANS OF SUPPORT, SHALL CONTAIN ADEQUATE AND CONTINUOUS METHODS OF SUPPORT FROM UNDISTURBED TRENCH BOTTOM SOIL VERTICALLY TO THE SUPPORT STRUCTURE AND THROUGHOUT ITS LENGTH. ALTERNATE SUPPORTS SHALL BE APPROVED BY COMPANY REPRESENTATIVES AND LAND OWNERS IN ADVANCE.
5. ALL MATERIALS SHALL BE FURNISHED BY THE PROJECT OWNER AND OR CONTRACTOR.
6. PRIOR TO REPAIRING TILE, CONTRACTOR SHALL PROBE LATERALLY INTO THE EXISTING TILE THE FULL WIDTH OF THE RIGHT OF WAY TO DETERMINE IF ADDITIONAL DAMAGE HAS OCCURRED. USE OF ACCEPTED VIDEO CAMERA EQUIPMENT FOR INTERNAL INSPECTION MAY ALSO BE CONSIDERED. ALL DAMAGED/DISTURBED TILE SHALL BE REPAIRED AS NEAR AS PRACTICABLE TO ITS ORIGINAL OR BETTER CONDITION.